

Former Emerson Street Landfill Sub-Slab Ventilation Guidance Document Update 2013

Prepared for:

City of Rochester Division of Environmental Quality
30 Church Street
Room 300B
Rochester, New York 14614

LaBella Project No. 210173

October 2013

Former Emerson Street Landfill Sub-Slab Ventilation Guidance Document Update 2013

Prepared for:

City of Rochester Division of Environmental Quality
30 Church Street
Room 300B
Rochester, New York 14614

LaBella Project No. 210173

October 2013

LaBella Associates, P.C.
300 State Street
Rochester, New York 14614

TABLE OF CONTENTS

1.0	INTRODUCTION AND BACKGROUND	1
2.0	EXISTING SITE CONTAMINATION INFORMATION.....	3
2.1	Filling/Soil Gas	4
2.2	Groundwater Investigations	6
3.0	DETAILED QUADRANT DESCRIPTIONS	10
4.0	RECOMMENDED ADDITIONAL SAMPLING.....	14
4.1	Sampling Methods & Procedures	14
4.2	Interpreting Sampling Results	14
5.0	DESCRIPTION OF VENTILATION SYSTEMS	15
6.0	RECOMMENDATIONS FOR INSTALLATION AND MAINTENANCE.....	17
7.0	CONTACT INFORMATION.....	20

Figures:

Fig 1:	FESL
Fig 2:	Landfill Deposition by Year
Fig 3:	Landfill Deposition by Era
Fig 4:	Methane Contours
Fig 5:	Methane Building Screening results
Fig 6:	CVOCs in Groundwater with Groundwater Contours
Fig 7:	CVOCs in Soil & Soil Vapor
Fig 8:	Landfill Thickness Contours
Fig 9:	X-Section A-A'
Fig 10:	X-Section B-B'
Fig 11:	X-Section C-C'
Fig 12:	X-Section D-D'
Fig 13:	Building Sub-Slab Ventilation System Plan and Details
Fig 14:	Parking Lot/Paved Area Ventilation Plan and Details

Appendices:

Appendix 1	Example Specifications for Sub-Slab Ventilation System
Appendix 2	Select pages from “Guidance for Evaluating Soil Vapor Intrusion in the State of New York”, New York State Department of Health, 2006.
Appendix 3	Select pages from “DER-13/Strategy for Evaluating Soil Vapor Intrusion at Remedial Sites in New York”, New York State Department of Environmental Conservation, 2006.
Appendix 4	Select pages from “OSWER Draft Guidance for Evaluating the Vapor Intrusion to Indoor Air Pathway from Groundwater and Soils (Subsurface Vapor Intrusion Guidance)”, United States Environmental Protection Agency (USEPA), November 2002

TABLE OF CONTENTS (concluded)

- Appendix 5 Soil Gas Figures from “Former Emerson Street Landfill Remedial Investigation Report for Parcels 4, 10, and 11”, LaBella Associates P.C., and Geomatrix Consultants, Inc., March 2001
- Appendix 6 Executive Summary from “Soil Vapor Intrusion Assessment Report: Data Review, Site Screening & Site Prioritization, Former Emerson Street Landfill, NYSDEC Site #828023”
- Appendix 7 “Former Emerson Street Landfill Sub-Slab Ventilation Guidance Document” dated May 2000 by Haley and Aldrich of New York for the City of Rochester
- Appendix 8 “Former Emerson Street Landfill Sub-Slab Ventilation Guidance Document, Update 2007” dated October 2007 by LaBella Associates, P.C. for the City of Rochester
- Appendix 9 Example Annual Certification Form by LaBella Associates, P.C. for the City of Rochester
- Appendix 10 Site Specific Version of “OSWER Vapor Intrusion Assessment Vapor Intrusion Screening Level (VISL) Calculator, United States Environmental Protection Agency (USEPA), November 2012. Modified for FESL by LaBella Associates, April, 2013.
- Appendix 11 Example Building Survey Form by LaBella associates, P.C. for the City of Rochester.

**FORMER EMERSON STREET LANDFILL
SUB-SLAB VENTILATION GUIDANCE DOCUMENT
UPDATE 2013**

1.0 INTRODUCTION AND BACKGROUND

This series of guidance documents was developed to provide guidance in the design of sub-slab ventilation systems for buildings and paved areas constructed over solid waste and/or ash, and/or contaminated groundwater associated with the former Emerson Street Landfill (FESL). This guidance document was developed by LaBella Associates, P.C. (LaBella), on behalf of the City of Rochester's Division of Environmental Quality (DEQ), to update the document titled "Former Emerson Street Landfill Sub-Slab Ventilation Guidance Document, Update 2007" (the 2007 Guidance), by LaBella, which was in turn an update of the document titled "Former Emerson Street Landfill Sub-Slab Ventilation Guidance Document" dated May 2000 by Haley and Aldrich of New York for the City of Rochester (the 2000 Guidance).

The 2007 Guidance updated existing mapping with the results of the March 2001 LaBella and GeoMatrix report titled "Former Emerson Street Landfill Remedial Investigation Report for Parcels 4, 10, and 11", revised the quadrant system based on those results, and updated investigation and mitigation guidelines to incorporate the 2006 New York State Department of Health (NYSDOH) Guidance for Evaluating Soil Vapor Intrusion in the State of New York (2006 DOH Guidance). The 2007 Guidance also addressed the need to provide guidance for mitigation of paved areas.

In 2010, the City of Rochester began a Vapor Intrusion (VI) investigation to systematically assess potential vapor intrusion issues at the FESL. This work included detailed assessments of each existing building on the FESL, installation of additional monitoring wells, and sampling of these new wells and several existing wells, catalogue and review of existing historical data regarding the FESL, and review of stereoscopic historic aerial photographs. The results of that project were documented in the report released in June 2010, titled "Soil Vapor Intrusion Assessment Report: Data Review, Site Screening & Site Prioritization, Former Emerson Street Landfill, NYSDEC Site #828023" (VI Assessment Report). The VI Assessment Report improved the understanding of site history, sub-surface conditions, groundwater contamination, and vapor intrusion potential at the FESL, including the development of a detailed prioritization system for Vapor Intrusion potential at existing buildings on the FESL. This document incorporates these findings into a second update of the FESL Vapor Intrusion Guidance Document. The Executive Summary of the VI Assessment Report is included as Appendix 6 to this document. In addition, this document has been reviewed for consistency with USEPA Engineering Issue: Indoor Air Vapor Intrusion Mitigation Approaches, published October 2008 (EPA/600/R-08-115).

Sub-slab vapor intrusion occurs when volatile hazardous chemicals accumulate beneath the building slab and migrate into the building due to a pressure difference between the building and the sub-slab. This pressure difference is most commonly present during the heating season. For landfill sites where methane gas and gas pressure are being actively produced through decomposition of waste, vapor intrusion is more likely throughout the year. The presence of landfill gas causes the threat of accumulation of explosive levels of methane, in addition to the health risks of long term exposure to lower levels. Other volatile

FORMER EMERSON STREET LANDFILL
SUB-SLAB VENTILATION GUIDANCE DOCUMENT
UPDATE 2013

organic chemicals, which can be found in landfills and other industrial and commercial sites, have the potential to migrate into buildings. Chlorinated volatile organic compounds (CVOCs) are of particular concern due to the toxicity associated with chlorine functional groups in organic molecules. The higher pressure caused by landfill gas can also force other hazardous gases into buildings.

The original 2000 Guidance Document became outdated due to the promulgation of new guidelines by the NYSDOH and the NYSDEC in October 2006. The NYSDOH document is titled “Guidance for Evaluating Soil Vapor Intrusion in the State of New York”, and the NYSDEC companion document is titled “DER-13 / Strategy for Evaluating Soil Vapor Intrusion at Remedial Sites in New York”. The NYSDEC document describes the State’s criteria for evaluating new and existing sites in order to determine whether these sites have the potential for exposures related to soil vapor intrusion. The FESL appears on the “List of Inactive Hazardous Waste Sites with Pre-2003 Remedial Decisions where Disposal of Chlorinated Hydrocarbons Occurred. The 2006 NYSDOH guidance includes recommendations for active depressurization systems, (as opposed to the passive systems described in the 2000 Guidance Document), as well as recommendations for testing and reporting. The 2007 Guidance took into account these recommendations.

It should be noted that the City of Rochester has applied an Environmental Institutional Control (EIC) to parcels located within the FESL. The EIC system requires DEQ approval as part of the City Permit process for any construction activity on a parcel flagged by the system. The City of Rochester coordinates with the New York State Department of Environmental Conservation (NYSDEC), New York State Department of Health (NYSDOH) and/or Monroe County Department of Health (MCDOH) as needed.

The FESL is a 280 acre area comprising 46 parcels located in northwest Rochester that operated as a Municipal Landfill from prior to 1951, but after 1930, until its closure in 1971. The Site is bisected by Emerson Street, and bounded by Lexington Avenue to the North, Colfax Street and railroad tracks to the East, Ferrano Street to the South, and the Barge Canal and Lee Road to the west. The landfill accepted incinerated municipal waste initially from the Falls Street Garbage Reduction Plant, and following 1954 from an on-site incinerator. Poor incineration efficiency at the on-site incinerator from 1964 onward, and possibly at the Falls Street Garbage Reduction Plant, resulted in deposition of highly putrescible waste at the FESL. Putrescible waste poses multiple difficulties for future redevelopment. First, its decomposition results in differential settling, requiring more comprehensive building structures. Second, the decomposition of the waste produces methane and other landfill gasses, which pose the threat of accumulation in buildings resulting in potential explosion or chronic toxicity. As part of the 2000 Guidance Document and again in the 2010 investigation, historic aerial photos were reviewed to determine which areas of the landfill were being used at times of low-incinerator efficiency. The main area of highly-putrescible waste deposition is located in Quadrant A (described below and depicted on Figure 1), and corresponds to waste deposition from 1964 through 1971. A smaller area may exist in Quadrant D, south of Emerson Street, which corresponds to deposition prior to 1954. Alternatively, the Quadrant D methane may derive from the native marshy soil which is high in organic material and peat.

FORMER EMERSON STREET LANDFILL
SUB-SLAB VENTILATION GUIDANCE DOCUMENT
UPDATE 2013

A portion of the FESL is listed as an Inactive Hazardous Waste Site (IHWS), due to the presence of chlorinated solvent contamination. The area of contamination is referred to as the P-1 Plume, in reference to the well in which the contamination was first detected. The source of this contamination is unknown, but is hypothesized to be the result of either possible direct disposal of liquid waste in the early 70's, or fire-fighting practice following landfill closure. The P-1 Plume is located in Quadrant A, described below, and depicted on Figure 6. Landfill disposal by year and the limits of the IHWS are shown on Figure 2.

Available analytical data types relevant to soil vapor migration include the following:

- ground surface landfill gas flux measurements throughout the landfill from “Former Emerson Street Landfill, Modified Remedial Investigation”, H&A of New York, January 1994;
- soil gas measurements for methane, vinyl chloride (a CVOC), and the VOCs: benzene, toluene, ethylbenzene, and xylenes (BTEX) across a limited area (the state-listed IHWS portion of the landfill, see Figure 1) from “Former Emerson Street Landfill Remedial Investigation Report for Parcels 4, 10, and 11”, LaBella Associates P.C., and Geomatrix Consultants, Inc., March 2001;
- PID measurements taken in utility vaults and sewers along roadways surrounding the landfill;
- soil samples for select CVOCs from borings across the landfill; and
- groundwater samples for select CVOCs from wells installed across the landfill.

In this document, a methodology for selecting an appropriate ventilation system is described that is dependent on landfill gas and CVOC measurements in the geographic location of the proposed buildings or parking lot (with respect to the footprint of the FESL), and the type of foundation required for a building. In general, a more robust ventilation system is recommended in areas of either higher historical contamination measurements, or where high putrescible-waste content requires caisson foundation styles. Parking lot venting systems are recommended in areas with high historical methane measurements.

2.0 EXISTING SITE CONTAMINATION INFORMATION

During the course of numerous investigations since the closure of the landfill, various media at the site have been tested for landfill gas and VOCs. Site history and past investigations were reviewed in detail as part of the 2010 VI Investigation. Results relevant to soil vapor intrusion noted in the VI Report are summarized below.

2.1 Filling/Soil Gas

Summary of Pertinent Filling Information from the 1989 RCRA Report

The RCRA report indicated the following pertinent information on filling operations at the FESL in relation to VI:

- RCRA indicated four typical soil/waste profiles in the test boring logs reviewed by RCRA. These typical profiles included the following:
 - Municipal rubbish and ash (up to 16.5 feet) directly over dolomite bedrock.
 - Municipal rubbish and ash (up to 20 feet) directly over glacial till/recent deposits (at variable thicknesses of 0.5 to 10.5 feet) thence dolomite bedrock.
 - Reworked soils (up to 10 feet) directly over glacial till/recent deposits (at variable thicknesses of 1 to 8.5 feet), thence dolomite bedrock.
 - Glacial till/recent deposits (up to 16.5 feet) directly over dolomite bedrock.
- Bedrock contours indicated the rock surface elevation decreases in the north central and southeastern section of the FESL.
- An article in the Rochester Times-Union in November 1964 provides a picture of several drums within burning solid waste. [Note: To date, LaBella has not obtained a copy of this article or reviewed the picture.]

Summary of Pertinent Filling Information and Soil Gas Data from the January 1994 H&A Report

The H&A report indicated the following pertinent information on filling operations at the FESL in relation to VI:

- The report included a review of aerial photographs. A 1963 aerial was reviewed that indicated the following: “Fill placement from 1961 to 1963 was primarily to the north of the 1961 limit, with a major lobe of fill also extending to the west. Some fill activity was also apparent overlying much of the 1961 fill area north of Emerson Street. Fill activity south of Emerson Street appeared to be very limited.” The limited area south of Emerson Street was noted on a figure as within the current location of the 1425 and 1385 Emerson Street Parcel. [Note: As of the date of this report, LaBella has not been able to procure a copy of the 1963 aerial.]
- Open burning of waste was reported to have occurred in the late 1960s and early 1970s.

FORMER EMERSON STREET LANDFILL
SUB-SLAB VENTILATION GUIDANCE DOCUMENT
UPDATE 2013

- This investigation included collecting landfill gas measurements across the FESL area with specially-designed gas flux chambers. As summarized in the report, landfill gas is typically composed of 58% methane, 42% carbon dioxide, and trace amounts of hydrogen sulfide and other organic compounds. Methane emission rates varied in the FESL samples from a minimum of 7.8 to a maximum of 1200 $\mu\text{g}/\text{m}^2$ -minute.
- The H&A report also included analytical information for CVOCs in soil, groundwater, and utility vault water samples, and PID readings for utility vaults and manholes. Analytical results indicated the presence of CVOCs at various locations throughout the landfill, but concentrated in the IHWDS portion.

Additional details on the landfill gas (methane) and CVOC soil gas sampling by H&A are summarized with results by LaBella/Geomatrix for each quadrant below.

Summary of Pertinent Soil Gas Data from the LaBella and Geomatrix March 2001 Report

The LaBella/Geomatrix report indicated the following pertinent information on filling operations at the FESL in relation to VI:

Sampling was completed in soil, groundwater, sewers, and extensive soil gas points on the IHWDS portion of the FESL in previous studies (discussed above). Analytical results confirmed and further delineated (as compared with previous reports) the presence of CVOCs in the IHWDS portion of the landfill. The soil gas results for the specific constituents detected are briefly summarized below:

- Vinyl chloride concentrations ranged from 0.02 milligrams per cubic meter (mg/m^3) to 9 mg/m^3 ;
- Benzene concentrations ranged from 0.02 mg/m^3 to 0.6 mg/m^3 ;
- Total BTEX concentrations ranged from 0.48 mg/m^3 to 499 mg/m^3 ;
- Chlorobenzene concentrations ranged from 0.02 mg/m^3 to 1.6 mg/m^3 ; and,
- Methane concentrations ranged from 380 ppm to 790,000 ppm (i.e., 79%).

2.2 Groundwater Investigations

Environmental assessments of the FESL site involving subsurface explorations have occurred since approximately 1979. Groundwater has been investigated at the FESL site since approximately 1988. The following is a brief summary of historic environmental investigations that have included some level of assessment of groundwater flow and/or quality:

<u>Year</u>	<u>By (Study Area)</u>	<u>Description</u>
1988-1989	Recra Environmental, Inc. (Entire FESL)	Sampling of soil and bedrock, installation of 13 monitoring wells (“GW” series) and 5 piezometers (“P” series)
1992-1993	Haley & Aldrich (Entire FESL)	Sampling of soil, bedrock and soil gas, installation of 6 shallow bedrock wells and 4 deep bedrock wells (“MW” series), and 2 shallow ‘well points.’
2000	Geomatrix Consultants, Inc./ LaBella Associates, PC (Inactive Hazardous Waste Site at 1655 Lexington Ave.)	Sampling of soil and bedrock and installation of 6 shallow and 1 deep bedrock monitoring wells (“GMX” series).

Several other phases of subsurface investigations were performed historically for the Site; however these investigations generally focused on the nature and extent of overburden and landfill materials for smaller sites within the FESL and did not include detailed groundwater assessment. Exceptions to this include an investigation at the Chemical Sales site (located off-site to the south beyond the barge Canal) which included installation of three IWBZ wells (Designated DEC-MW-17, DEC-MW-18 and DEC-MW-20) on the FESL located at 55 and 105 Vanguard Parkway in 2000. In addition, five shallow monitoring wells (MW-5 through MW-9) were installed at 330 Colfax Street (currently leased by PEKO); these wells were installed to investigate petroleum impacts related to a former asphalt batch plant at this property.

These historic investigations have resulted in the installation and sampling 53 total wells at the Site. This includes 45 shallow bedrock (or overburden/bedrock interface) and 8 deep bedrock wells. During the ensuing years, several of the historic monitoring wells were damaged, lost or otherwise rendered unusable. Some of these monitoring wells were damaged or lost due to development and new construction. As part of the 2010 investigation, an inventory and assessment of all existing wells on the site was performed. The resulting inventory indicates that a total of 47 monitoring wells were still present on the site and in a serviceable condition. The 2010 investigation utilized 29 of these monitoring wells.

Summary of highlights from the 1993 Study

- The groundwater contour modeling indicated a groundwater divide generally coinciding with a bedrock surface high in the area. The groundwater flow, in general, was promoted to the northeast for the northeastern portions of the site and to the southeast for the remaining portions of the site.
- Petroleum hydrocarbons identified in deep well MW-15D appeared to be due to an off-site source.
- Groundwater flow is controlled by sewer trenches installed into bedrock.

Summary of highlights from the 2000 Study

- The groundwater flow system at the Site is comprised of two hydrostratigraphic units, an Upper Water Bearing Zone (UWBZ) and Intermediate Water Bearing Zone (IWBZ). Both zones are located in bedrock.
- Water levels typically reside in the rock but occasionally exist in the lower portions of the overburden/fill.
- Groundwater in the UWBZ is influenced by large diameter storm sewers running north/south along the eastern edge of McCrackanville Street and east/west within Emerson Street. These storm sewers were reportedly installed in blasted bedrock. All storm sewer inverts appear to be below bedrock in McCrackanville and Emerson Streets. Invert elevations of these sewers correspond closely to groundwater elevations. The table below illustrates the approximate bedrock elevation, and groundwater elevation for select wells and the nearest invert elevation available from Monroe County mapping.

Well	Bedrock Elevation	Groundwater Elevation	Nearest Sewer Invert Elevation
GMX-MW-3	525.39'	519.86'	517.08' (90 feet Southeast)
GMX-MW-6S	524.26'	516.51'	515.93' (150 feet East)
LAB-106	531.16'	514.06'	514.33' (90 feet North/Northeast)

Note: All elevations are NGVD 29.

As shown in the table above, the bedrock elevations range between about 6 and 16 feet above the groundwater elevation and about 8 to 17 feet above the elevation of the sewer inverts. The groundwater levels range between about 2.8 feet above the sewer inverts to about 0.3 feet below the sewer invert. Although the invert elevations are 90-feet away or more from the wells, this indicates that the sewers in McCrackanville and Emerson Street are at least 6 feet below the top of bedrock and appear to extend deeper into rock down Emerson Street and the portions west of W Street. Additionally, the groundwater levels correlate closely with the invert elevations, which indicates that groundwater is influenced by the fracture network in the bedrock in close proximity to the storm sewers which provide a preferential pathway for groundwater and thus a flow zone.

- The storm sewers are constructed in bedrock and some sections below the water table. Thus the

FORMER EMERSON STREET LANDFILL
SUB-SLAB VENTILATION GUIDANCE DOCUMENT
UPDATE 2013

sewer pipes and/or associated bedding are preferential flow paths for groundwater and act as linear drains.

- The UWBZ at the FESL in the area of P-1 plume at 1655 Lexington Avenue detected 17 VOCs in seven groundwater samples in 2000. Copies of the data summary tables are included in Appendix 3.
- Degradation products of CVOCs are present.
- The total CVOCs detected in 2000 in well GMX-MW-3 (located on the west side of the McCrackanville storm sewer) was 5,408 ppb while well GMX-MW-5 (also in 2000) showed a concentration of only 11 ppb. Well GMX-MW-5 is approximately 100-ft. east of well GMX-MW-3 and east of the McCrackanville sewer. This is further evidence of the hydraulic barrier of the sewer.
- Petroleum hydrocarbons were identified in the IWBZ; however, groundwater in this zone appears to flow to the north, does not appear to be influenced by the sewer system and appears to be associated with an off-site source to the south.
- Sampling and analysis of water in the storm sewer identified CVOCs in a manhole at the intersection of W Street and Emerson Street and two manholes south of this location. However, a sample from the canal outfall did not detect VOCs.

Summary of highlights from the 2010 Study

The 2010 groundwater investigation included the following elements:

- Inventory, assessment and re-development of the previously-installed monitoring wells
- Drilling of nine test borings through overburden and into bedrock, and obtaining soil and rock core samples
- Installation of nine new groundwater monitoring wells, designated LAB-101 through LAB-109
- Decommissioning and replacement of existing well GW-7 (with replacement well GW-7R), due to excessive siltation
- Rehabilitation of existing well GW-9, due to partial burial of the well casing
- Sampling for VOCs and water quality indicator parameters (i.e., ORP, pH, DO, etc.) of all newly-installed and previously-installed wells using primarily low-flow sampling methodology
- Survey of all new, replaced and rehabilitated wells and collection of groundwater elevations

Groundwater Quality

This section provides a summary of the groundwater quality observed in sampled wells. This discussion includes results from historic sampling events as well as the 2010 sampling.

Previous investigations completed at the FESL have documented groundwater conditions across most of the site, both on a site-wide and parcel-specific scale. The following is a summary of significant findings from these previous investigations:

- A chlorinated VOC (CVOC) plume in groundwater is located on the City-owned parcel at 1655 Lexington Avenue, which comprises approximately 60% of the approximate 24

FORMER EMERSON STREET LANDFILL
SUB-SLAB VENTILATION GUIDANCE DOCUMENT
UPDATE 2013

acre NYSDEC-listed IHWD Site. Given that total CVOCs in Monitoring Well P-1, located in the apparent source area of the plume, have historically been as high as approximately 54 parts per million, dense non-aqueous phase liquid (DNAPL) may be present based upon the > 1% solubility for CVOCs per DER-10. Although the P-1 well location is presumed to be located at or near the source of contamination, the entire source area is not clearly defined.

The CVOC plume extends generally toward the east and south from well P-1. Capture of the impacted groundwater by the storm sewers located along the east and south limits of the IHWDS appears to have limited the extent of the plume. Some extension of the plume to the south and east beyond the storm sewers in Emerson Street and McCrackanville has occurred; however, the extent is limited and CVOC concentrations in wells on the opposing side of these sewers were greatly reduced or were non-detect.

- CVOCs at significantly lower concentrations than the IHWDS area described above have been identified in other areas of the FESL. These occurrences appear to be limited in lateral extent and based on location and filling history, may be the result of post-landfill site uses.
- At least one off-site source of non-chlorinated, petroleum-related VOCs has been identified. The petroleum-impacted groundwater is in the IWBZ, at deeper levels than the CVOC impacts discussed above.
- Based on the body of historic data, the detailed evaluation completed as part of the VI Report and the current heavy manufacturing setting of the FESL, a list has been developed of the analytical compounds suspected to be due to FESL (P1-Plume and surrounding wells) which includes tetrachloroethene, trichloroethene, and their breakdown products. These compounds will hereafter be collectively referred to as "FESL List".

As indicated above, the 2010 investigation included groundwater sampling of nineteen previously-installed, one replacement and nine newly-installed monitoring wells. The primary focus of the analyses was VOCs, using USEPA Method 8260B. As a general summary: twenty of the twenty nine recently-sampled wells contained VOCs at levels at or above the method detection limit (MDL); nine wells showed no detectable VOC presence. Of the twenty wells with VOCs detected, eleven did not contain VOCs at concentrations in excess of the NYSDEC's Part 703 Drinking Water Standards. The remaining nine wells contained one or more VOCs at a concentration that exceeded the standards. Seven of these nine wells exhibiting exceedences were located on or in close proximity to the IHWD site, and are related to the previously-identified VOC plume. The remaining two wells (GW-7R and GW-9) are located on Colfax Street and appear to represent sources of VOCs separate from the IHWD site and may be due to post-landfilling site uses.

3.0 DETAILED QUADRANT DESCRIPTIONS

The FESL can be separated into four general geographic regions (FESL Quadrants) based on the landfill waste composition and historic analytical data. The composition of landfill material will likely impact the type of building design that will be developed. Buildings constructed over areas of high non-ash, potential putrescible solid waste will more likely have pier or caisson-style foundations to provide structural stability, and this type of foundation does not allow easy implementation of a plastic sheeting type liner as a vapor barrier. For caisson or pier type foundations, cold-spray applied membrane liners are recommended. Conversely, a standard concrete footing with slab on grade foundation type is more amenable to implementation of a system utilizing a plastic sheeting type vapor barrier.

Quadrant A is the northwestern portion of the FESL and is defined on the north by Lexington Avenue, the west by Lee Road, the south by Emerson Street, and the east along the property line between 1570 and 1580 Emerson Street and bisects 60 McCrackanville, 575 Colfax and 655 Colfax. Quadrant B is the northeastern portion of the FESL and is defined on the north by Lexington Avenue, the east by Colfax Street and the South by Emerson Street. The western border of Quadrant B is Quadrant A. Quadrant C is the southwestern portion of the FESL. The eastern border of Quadrant C is Quadrant D at Colfax Street. Quadrant D is the southeastern portion of the FESL. As discussed in later sections, the quadrants are defined by significant differences in subsurface conditions (i.e., fill materials, groundwater impacts, etc.) The characteristics of the FESL Areas are summarized below:

Quadrant A (North of Emerson Street, West of Colfax Street):

Quadrant A is characterized by the presence of both insufficiently incinerated highly putrescible waste, and illegally disposed chemical waste, resulting in the presence of methane gas, as well as CVOC contamination in soil vapor and groundwater. Methane flux was measured at levels ranging from 33 to 1,200 ug/m²-min, and/or soil gas methane concentrations were recorded above 5,000 ppm. During the VI Investigation methane was detected during field screening at 1740 Emerson Street at levels of 0.1%. Methane contours inferred from 1994 H&A and 2001 LaBella/Geomatrix sampling events are depicted on Figure 4. Methane detections in buildings are summarized on Figure 5. Groundwater CVOC contamination contours are depicted on Figure 6. Soil vapor CVOC contours are depicted on Figure 7. The fill material in this area ranges in thickness from no fill material observed in the western portion of the quadrant to approximately 23-ft. thick in the central portion of the quadrant. Fill thickness contours are depicted on Figure 8. The cover thickness in this quadrant ranges from less than 1-ft. in the northeastern portion of the quadrant to greater than 3-ft. in the central portion of the quadrant. Underlying the cover material, the fill consists of putrescible waste (wood, paper, misc. refuse,), metal, plastic, rubber, brick, glass and some ash in the central and northern portions of the quadrant and predominantly ash in the southern portion of the quadrant in proximity to Emerson Street. This is consistent with the historic information reviewed. Some locations within this quadrant were noted to have fill material placed directly on bedrock, which would indicate portions of the quadrant were

FORMER EMERSON STREET LANDFILL
SUB-SLAB VENTILATION GUIDANCE DOCUMENT
UPDATE 2013

excavated prior to filling. Some testing locations indicated apparent native material beneath the fill materials and overlying the bedrock. This native material included in some locations silt and peat deposits which would be consistent with a marsh/swamp area. Locations without fill materials (generally the western portion of the quadrant), the native material consisted of silts and sands.

This quadrant was generally the last to be filled and as such the fill material varies from fully combusted ash material in the southeastern corner to partially incinerated or direct burial of unincinerated or putrescible solid waste in the central portions. The western portion of this quadrant was generally not filled and the 500 Lee Road parcel underwent a fill relocation project during construction and as such fill materials are not located beneath the main building or power house building. The central portion of Quadrant A contains the P-1 plume area which is likely due to either 1) direct disposal of waste solvents sometime around the closing of the landfill (1971) or after closure or 2) fire training operations by GM, at which time the property was owned by the State of New York. Methane due to the FESL at concentrations (based on field meters) within the explosive range and CVOCs have been documented in soil gas in the central portion of this quadrant.

Quadrant A contains the highest VOC impacts to groundwater in the entire FESL site. A sample from monitoring well P-1 located at 1655 Lexington Avenue, the apparent source area, in 2000 contained total VOCs at 54,422 parts per billion (ppb). The most recent sampling event (July 2010) showed a decrease in CVOC concentrations to 34,007 ppb (a decrease of 37 percent). However, total concentrations are still within percent levels and there is a potential for DNAPL. Relatively low levels (19.2 ppb) of petroleum-related VOCs (benzene, toluene, ethylbenzene and xylene, or BTEX) were also detected in the 2010 event.

The groundwater sampling results indicate a CVOC plume exists in Quadrant A which extends to the southeast and south from the P-1 source area. The plume extends southward to Emerson Street and slightly beyond (into Quadrant C). In Quadrant A, well GMX-MW4, located only 225 feet east of P-1 showed only 1.5 ppb CVOCs. Wells GMX-MW-3 and GMX-MW-6S (both located on the east side of the McCrackanville Street storm sewer), which appear to represent the most direct downgradient well locations in relation to well P-1 (based on the inferred flow directions), showed CVOC concentrations of 2,031 and 89.5 ppb, respectively in the July 2010 sampling event. These results are approximately one to two orders of magnitude less than the source area well. It should be noted that CVOC concentrations in well MW-6S increased from 3 ppb in 2000 to 89.5 ppb in 2010.

Quadrant B (North of Emerson Street, East of Colfax Street):

Quadrant B was also landfilled during the period of low-incinerator efficiency, resulting in the presence of both highly putrescible waste, and methane. Methane flux readings in this quadrant ranged from 15 to 140 ug/m²-min. During the VI investigation, methane was detected in the building located at 575 Colfax Street at concentrations up to 14.3%. An apparent discrete CVOC plume is also present in this quadrant (i.e., separate from the P-1 plume in Quadrant A); however, this plume appears limited in extent and generally is within the 535 Colfax Street parcel, and is believed to be related to post-landfill operations.

FORMER EMERSON STREET LANDFILL
SUB-SLAB VENTILATION GUIDANCE DOCUMENT
UPDATE 2013

CVOCs in soil gas were not extensively studied within this quadrant.

The fill material thickness in this area ranges from no fill material in the northeast portion of the quadrant to 22.5-ft. thick in the western central in portion of the quadrant. The cover thickness in this quadrant ranged from less than 6-inches to up to 2-feet thick. Underlying the cover material, the fill consists of ash, petruscible waste (wood, paper, and misc. refuse), metal, plastic, rubber, brick, glass, etc. in the central and northern portions of the quadrant and predominantly ash with some petruscible waste in the southern portion of the quadrant. Fill material in some locations was noted to be directly on top of bedrock, while other locations indicated apparent native material between the fill and bedrock. Native organic materials (peat) were noted in several borings overlying the bedrock. Locations without fill materials (generally the western portion of the quadrant), the native material consisted of silts and sands.

This quadrant began to be filled sometime around 1960 and until 1970. A majority of this quadrant was covered and seeded in 1970 based on a review of contract documents and this appears consistent with the 1971 aerial photo. Few soil gas points have been installed in this quadrant, and thus methane in soil gas is not well characterized; however, the available data shows significantly lower concentrations in soil gas than in the central portion of Quadrant A. The fill materials in this quadrant consist of ash material in the southern portion and some partially incinerated or direct burial/petruscible waste in the central to northern portions. The thickness of fill materials ranges from no fill to greater than 20 feet in the western central portion of the quadrant. The 655 Colfax Street building (Edison Tech) contains a basement built directly on bedrock and thus a complete removal of fill material was completed for the north and south portions of the main building. The service station building appears to be outside the filling limits. In addition, the 1560 Emerson Street building has undergone two additions and both of these received partial fill removals at that time.

The impacted CVOCs in groundwater within the southeastern portion of this quadrant may be due to post-landfill operations. This is apparent since as late as July 1969 it appears that the City of Rochester was not accepting liquid waste, at least for direct burial, and incineration even when incomplete would likely provide complete combustion of a solvent. Furthermore, this area was developed in 1985 as a metal fabrication facility which could have used chlorinated solvents and concentrations of CVOCs in this area have been found to increase over time.

Quadrant C (South of Emerson Street, East of Colfax Street):

Quadrant C was landfilled during the years of maximum incinerator efficiency, with the result that methane detections there are the lowest of the FESL quadrants. Methane was detected in field screening of wells in the southeastern portion of the quadrant during the VI Investigation, but additional testing indicated that these results were not related to landfill gas, but were caused by thermogenic gas typical of the Rochester Shale geologic unit which underlies the FESL and which the subject wells were screened in. It should also be noted that the heterogeneous nature of the thermogenic gas was observed to skew the readings on the field meter used to screen for landfill gas. Field readings of >65% and 30% greatly exceeded laboratory results of 4.17% and 1.45%, at MW-15D and in the 'Stickup Gas Well', respectively. Because the meter is calibrated for methane (true landfill gas is nearly entirely methane), the presence of other gases in thermogenic gas including propane and butane, distorts the readings taken in the field, and

FORMER EMERSON STREET LANDFILL
SUB-SLAB VENTILATION GUIDANCE DOCUMENT
UPDATE 2013

indicates substantially higher methane concentrations than actually present.

This quadrant began to be filled in the 1930s or 1940s in the southeastern corner and expanded north and west until about 1961 when landfilling likely ceased in this quadrant. The fill materials generally consist of ash materials; however, some paper and wood were noted in select testing locations. Portions of this quadrant were also noted to have fill material placed directly on bedrock and in other locations to contain marsh deposits between the fill material and bedrock. Soil gas testing in this quadrant is limited; however, the testing completed did not indicate significant landfill gas flux readings. Two fill material removal actions have occurred in this quadrant during redevelopment work. Specifically, all fill material beneath the 55 Vanguard Parkway building was removed during construction and all fill material encountered on the 105 Vanguard Parkway was removed during site development.

Methane flux readings in Quadrant C were nearly identical to the control sample, at 33 to 35 ug/m²-min, however, only two soil gas sampling locations were located within this quadrant. In addition, the presence of organic rich marsh-derived soils at depth in this quadrant could also be a source of methane.

CVOCs are present in groundwater in the north-central portion of Quadrant C, immediately south of Emerson Street and east of Vanguard Parkway. It is not known whether this plume is related to the P-1 plume in Quadrant A, or the result of a separate source, although the answer may well be 'both', with the groundwater contamination present along Emerson Street likely stemming from the P-1 plume, and shallow soil contamination further south possibly derived from its own source, which does not appear yet to have impacted groundwater in the immediate vicinity.

The fill material in this area ranges from no fill material in the western portion of the quadrant to 11.2-ft. thick in the central and north-central portion of the quadrant. The cover thickness in this quadrant ranged from no cover to up to 3-ft. thick. Underlying the cover material, the fill consists predominantly of ash material with some slag and cinders. It should be noted that some borings indicated lesser (trace) amounts of paper or wood; however these were not the predominant material. Some locations within this quadrant were noted to have fill material overlying directly on bedrock, while others contained native materials between the fill and bedrock. The native materials included apparent marsh deposits (clayey silt with organics) in some locations up to 5-ft. thick.

Quadrant D (South of Emerson Street, West of Colfax Street):

Quadrant D may have received partially incinerated material from prior to the 1954 construction of the on-site incinerator, which may account for the presence of methane. According to a 1954 Democrat & Chronicle article, the "Cobwell units in the [Falls Street Garbage Reduction] plant are too old for efficient operation". Native marsh soils may also account for or contribute to methane detections. Methane flux readings of up to 190 ug/m²-min were detected in the central portion of the quadrant. The location of borings with methane detections during 2009 site investigation work at 1355-1365 Emerson Street followed closely with the contours inferred from the site-wide surface flux measurements shown on Figure 4. A small plume of CVOCs was detected in one well along Colfax Street, but this plume appears to have been caused by industrial site operations subsequent to the closure and re-development of the FESL.

The fill material in this area ranges from no fill material in the eastern and portions of the northern section of the quadrant to 11.5-ft. thick in the central portion of the quadrant. The cover thickness in this quadrant ranged from less than 6-inches to less than 3-ft. thick. Underlying the cover material, the fill consists predominantly of ash with some cinders, slag and glass noted. In addition, some wood and charred paper were noted in select borings. Some locations within this quadrant were noted to have fill material overlying directly on bedrock, while other locations noted apparent native material between the fill material and bedrock. The native material in some locations included apparent marsh deposits (clayey silt with organics) in some locations up to 6.8-ft. thick.

4.0 RECOMMENDED ADDITIONAL SAMPLING

This section describes the recommended additional sampling prior to redevelopment of FESL parcels. Please note that the document “Guidance for Waste-fill Management During Site Development on the Former Emerson Street Landfill” dated May 2013, by LaBella Associates for the City of Rochester, should also be consulted prior to any disturbance of the sub-surface at the FESL.

4.1 Sampling Methods & Procedures

Site specific soil gas sampling is recommended, though not required, prior to redevelopment. Predevelopment sampling would be particularly useful in Quadrants C and D where less comprehensive data is available. Recent information would be of great value in customization of the design of sub-slab depressurization systems and parking lot vent systems. In the case of parking lots, quantitative sampling could demonstrate that there is no need for a vent system.

If sampling is performed, it is recommended that data be collected from soil gas points advanced approximately 4-feet below ground surface, or at a depth that corresponds to the depth of the building slab. Soil gas samples can be analyzed either qualitatively or quantitatively. Qualitative analysis can be done using a PPB RAE for total VOCs and a portable gas analyzer for methane. Quantitative analysis can be done with a portable gas chromatograph, or sample collection and laboratory analysis for methane and FESL List CVOCs. It should be noted that non-FESL CVOCs, and petroleum related VOCs may also be present. Analysis for non-FESL related VOCs would be helpful for design of site-specific mitigation measures, but is at the discretion of the site owner. NYSDOH guidance indicates sampling using low flow rates (less than 0.2 liters per minute) using Summa Canisters that are pre-cleaned by the laboratory. The typical analytical method for VOCs is the United States Environmental Protection Agency (USEPA) Method TO-15. Detailed guidance on soil gas sampling is provided in the NYSDOH “Guidance for Evaluating Vapor Intrusion in the State of New York”, portions of which are reproduced as Appendix 2 of this document.

4.2 Interpreting Sampling Results

A useful resource for understanding the significance of measured concentrations of different soil gas contaminants is the USEPA document entitled “OSWER Draft Guidance for Evaluating the Vapor Intrusion to Indoor Air Pathway from Groundwater and Soils (Subsurface Vapor Intrusion Guidance)”,

FORMER EMERSON STREET LANDFILL
SUB-SLAB VENTILATION GUIDANCE DOCUMENT
UPDATE 2013

November 2002. Select pages from this guidance are included as Appendix 4. In 2012, EPA developed a new spreadsheet tool titled “OSWER Vapor Intrusion Assessment Vapor Intrusion Screening Level (VISL) Calculator. Site data have been entered into this spreadsheet and the relevant spreadsheet has been printed and included as Appendix 10. [Note: NYSDOH may be developing additional lookup tables or matrices, as such; NYSDOH should also be consulted once sample results are available.] Please also note that a new EPA guidance document titled “OSWER Final Guidance for Assessing and Mitigating the Vapor Intrusion Pathway from Subsurface Sources to Indoor Air” is currently available for public review until May 2013, and will be finalized thereafter. This document will supercede the November 2002 Guidance referred to above.

5.0 DESCRIPTION OF VENTILATION SYSTEMS

Buildings:

Due to the potential presence of methane and/or CVOCs, engineering controls are recommended at all new buildings constructed within the footprint of the landfilling at the FESL, as indicated on Figures 2 and 3. Areas that are within the site boundary but outside landfill areas may be demonstrated to not require ventilation systems based on sampling and analysis. It should be noted that for VOCs, soil gas testing in the absence of a slab and the associated pressure differential may not be a good predictor of the absence of a soil vapor migration problem. Following building construction, additional testing would be required, per the NYSDOH guidance, and if vapor migration were found to be occurring, a ‘retrofit’ system would need to be designed and built. It is more cost effective, easier and more effective to build a system prior to building construction than afterwards. With that in mind, the basic system recommended for buildings is an active sub-slab depressurization system. For all Quadrants, it is recommended that the system consists of the following components:

- an impermeable vapor barrier that inhibits migration of landfill gases through the sub-slab and into the building (see below for specifics);
- sub-slab vent pipes that provide a conduit for landfill gas to the exterior of the building;
- fans attached to the vent pipes that result in active depressurization of the sub-slab;
- an alarm system demonstrating that the system is operating, which should be located conspicuously in an area frequented by a person responsible for monitoring the system’s status (an informational sheet with emergency contact information and that briefly describes the operation of the system should be available in the alarm area);
- crushed stone placed in vent-pipe trenches and a layer of crushed stone or sand (depending on the structural needs of the slab) beneath the entire slab to act as a high permeability zone for gas migration and pressure field extension; and
- permanent gauge points to evaluate the effectiveness of the system.

FORMER EMERSON STREET LANDFILL
SUB-SLAB VENTILATION GUIDANCE DOCUMENT
UPDATE 2013

LaBella recommends the impermeable vapor barrier liner for the system be one of the two following types:

- Type I: 15 mil reinforced polyethylene sheeting; or,
- Type II: 60 mil spray-applied membrane

The Type I liner is appropriate for buildings constructed with a standard concrete footing with slab on grade type foundation. The Type II liner is appropriate for buildings constructed with caisson or pile type foundations.

Example building layouts and construction details are provided in Figures 13 and 14. Example specifications are provided in Attachment 1.

A conceptual decision matrix for determining the recommended sub-slab ventilation system type is presented below:

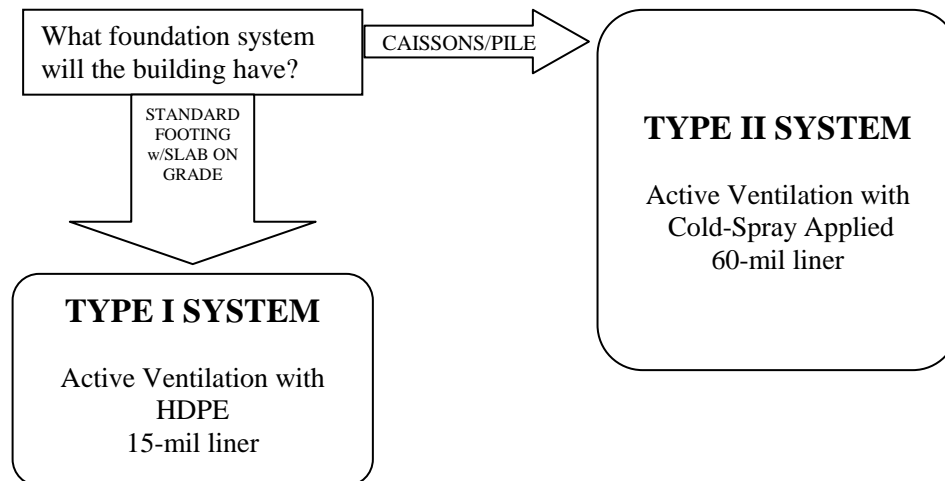

Parking Lots/Paved Areas:

When landfills that contain actively decomposing materials are capped, there are concerns that methane gas may accumulate to levels that could cause the threat of explosion. It is therefore recommended that when parking lots or other paved areas are planned within the FESL footprint, a vent system be designed to prevent methane accumulation. Areas not identified as methane areas on Figure 4 may not require vent systems if soil gas test results do not show methane gas evolution above 40 $\mu\text{g}/\text{m}^2$ -minute, or 100 ppm soil gas methane. While no definitive standards exist for methane gas levels, the 40 $\mu\text{g}/\text{m}^2$ -minute value is based on being elevated with respect to a background sample of approximately 30 $\mu\text{g}/\text{m}^2$ -minute; and the 100 ppm value is based on elevation above natural background levels of 0 to 50 ppm. The evacuation action level is 5,000 ppm, or 10 % of the lower explosive limit (LEL) for methane, as determined by the

U.S. National Fire Code.

As a rule of thumb, vents should be placed every 200 feet. Venting systems can be constructed either as well points (simpler and less expensive), or with horizontal piping lengths similar to the building sub-slab depressurization systems. Well points or horizontal piping should be screened/placed in the upper five feet of fill. All vents should be equipped with a stack that extends at least as high as the rooftops of nearby buildings, or 35 feet, whichever is greater. Stacks can be affixed to lighting systems as structural support when feasible. The stack may terminate in a water intrusion prevention device, a wind-driven exhaust turbine, or a flare, depending on the methane concentrations. Flares are only appropriate when a horizontal system is used, or the area to be paved is small enough (4000 sq ft) to be served by a single vent. Systems utilizing flares may be subsidized by the State when built in cooperation with the City. Flares are beneficial to the environment because they combust the methane to carbon dioxide (a less active greenhouse gas than methane) and water vapor. They are also helpful in preventing odor problems.

Example layouts and construction details are provided in Figures 13 and 14.

Air Emission Permitting/Registration Status:

According to the provisions of Title III 201-3.3.c of the New York State Air Pollution Regulations, emissions of methane, and trace constituents that are less than 1 percent by weight for any regulated air pollutant, or 0.1 percent by weight for any carcinogen, are classified as 'trivial' and are exempt from registration and permitting provisions of subparts 201-4 and 201-5. Benzene and vinyl chloride are the only carcinogens known to be present in soil vapor at the FESL. The highest known concentrations of benzene and vinyl chloride in soil gas at the site (measured by Geomatrix in 2001) are 0.000048 and 0.00072 percent, respectively. Concentrations of CVOCs in other media do not approach the 1 percent level, nor the 0.1 percent level, making it unlikely that higher concentrations would exist in the air in the vicinity of the contaminate media. Nonetheless, site specific soil gas data should be collected to confirm the registration exemption status prior to construction of a system.

6.0 RECOMMENDATIONS FOR INSTALLATION AND MAINTENANCE

The following recommendations are for general guidance purposes only, and are not to be used as construction specifications. Construction specifications should be developed by a qualified professional on a site-specific basis. Similarly, specific requirements for system maintenance and reporting should be coordinated with the appropriate regulatory agency or agencies (e.g. NYSDEC, MCDOH, NYSDOH, etc.)

General Building Sub-Slab Depressurization System Installation Recommendations:

- Design the layout of the piping so that the spacing between each piping length is approximately 15 feet.
- Limit the initial length of pipe running on one fan to 150 to 200 ft. Following initial radius of influence testing, pipe runs can be consolidated to run on as few fans as testing demonstrates can achieve adequate pressure fields. Radius of influence testing can only be done once the

FORMER EMERSON STREET LANDFILL
SUB-SLAB VENTILATION GUIDANCE DOCUMENT
UPDATE 2013

slab/asphalt surface course is in place.

- Include piping routed to separate fans around the perimeter of the building, as this is a common ‘short-circuit’ area. This will protect the rest of the system from pressure ‘short-circuiting’.
- It is recommended that the installation of the system be overseen and/or inspected by a qualified professional. Regulatory agencies (e.g. NYSDEC, MCDOH, NYSDOH, etc.) may require submission of a report that documents the installation of the system.
- Explosivity testing should be conducted on the vented air in each leg of the system before and during initial operation. It is recommended that the explosivity testing be performed prior to the purchase of exhaust fans. If the explosivity testing indicates significant levels of landfill gases (>5,000 ppm methane or 10% LEL), intrinsically safe fans are required.
- The degree to which the system can be refined for maximum efficiency (smallest number of fans) depends on the number of test points installed, since fans can only be eliminated when it is demonstrated that sufficient coverage is provided by fewer fans.
- Avoid sharp items (e.g. larger stones, rebar) that could damage the integrity of the vapor barrier or piping, as appropriate.
- Install an audible and visible alarm that will alert occupants if the fans stop operating.

General Building Sub-Slab Depressurization System Startup Recommendations:

- Upon system completion, perform a positive-pressure smoke test of the vapor barrier and the system to detect any leaks around concrete cracks, floor joints, and at the suction point. Any leaks identified should be resealed until the smoke test passes (i.e., no smoke observed).
- Test buildings with natural draft combustion appliances for backdrafting and correct as necessary.
- Conduct a Pressure Field Extension test using the installed test points per the 2006 NYSDOH Guidance Document. The test can be performed by attaching a manahelic micro pressure gauge to the gauge end, or by observing smoke being drawn in to the gauge end. This test must demonstrate that a vacuum is being created beneath the entire slab. [Note: This test is included in the 2006 NYSDOH Guidance. See Appendix 2.]
- When possible, route gauge points for pressure test points outside the building through the foundation rather than through the building floor, as slab penetrations provide potential contamination paths for future chemical spills.

Sampling Recommendations

In general, no air sampling is required, but may be helpful in certain instances described below.

- Air sampling is indicated if there is any indication of possible impediments to comprehensive sub-slab communication of the depressurization system (i.e., locations with wet or dense sub-slab soils, multiple foundations and footings, minimal pressure differentials between the interior and

FORMER EMERSON STREET LANDFILL
SUB-SLAB VENTILATION GUIDANCE DOCUMENT
UPDATE 2013

sub-slab). In buildings with basements, post-mitigation indoor air sampling from the basement alone (i.e., without a concurrent indoor air sample from the first floor) is recommended in most circumstances. See the NYSDOH Guidance Document, Section 3, for sampling protocols.

- At the time of any air sampling, it is necessary to conduct a complete building survey to document any chemical use or storage and other site conditions that may result in false positive results for indoor air quality. New construction materials such as mastics, paints, caulks, blinds, etc should be noted as they can off-gas VOCs that may be incorrectly interpreted as evidence of VI. An example building survey form is included as Appendix 11.
- Typically, post-mitigation sampling should be conducted no sooner than 30 days after installing a depressurization system. If the system is installed outside of the heating season or at the end of a season, post-mitigation air sampling may be postponed until the heating season, per the DOH.

System maintenance/monitoring recommendations:

- Inspect external portions of the systems, including fans, piping, alarms, labeling, etc., annually to evaluate system integrity. Repair or replace components as necessary.
- Inspect fans monthly to ensure they are operating properly and are securely mounted. Repair or replace components as necessary.
- Inspect exhaust points monthly to ensure they haven't become plugged or blocked. Inspect more frequently in cold weather to ensure the exhaust points are not clogged by snow or ice.
- It is recommended that system inspections and maintenance be performed on a regular basis and that documentation of these activities be generated and retained. Regulatory agencies (e.g. NYSDEC, MCDOH, NYSDOH, etc.) may require that copies of such documentation be submitted. An example annual certification form is included as Appendix 9.
- Perform other maintenance activities as specified by manufacturer of installed equipment.

FORMER EMERSON STREET LANDFILL
SUB-SLAB VENTILATION GUIDANCE DOCUMENT
UPDATE 2013

7.0 CONTACT INFORMATION

The individuals, agencies, and organizations listed below may be contacted for additional information:

Joseph Biondolillo
City of Rochester, Department of Environmental Services
Division of Environmental Quality
30 Church Street, Room 300B
Rochester, NY 14614
(585) 428-6649

Todd Caffoe
NYSDEC Region 8
Div. of Hazardous Waste Remediation
6274 E. Avon Lima Road
Avon, NY 14414
(585) 226-2466

Mark Gregor
City of Rochester, Department of Environmental Services
Division of Environmental Quality
30 Church Street, Room 300B
Rochester, NY 14614
(585) 428-5978

J:\ROCHESTER, CITY\210173 FESL\REPORTS\2013 SUB-SLAB VENT GUIDANCE\RPT.2013.04.15.FINALEDITS_SUBSLABVENT2013.DOC

LABELLA
LaBella Associates, P.C.

300 State Street
Rochester, New York 14614

Figures

FORMER EMERSON STREET LANDFILL
SUB-SLAB VENTILATION GUIDANCE UPDATE 2012
CITY OF ROCHESTER

General Site Information

- Railroad
- Cross-Section Alignments
- Building
- FESL Project Parcel
- Parcel Boundary
- Inactive Hazardous Waste Site
- Quadrant
- Site Boundary

Note: Refer to Figures 9 through 12 for Cross Sections A through D respectively.



0 400 Feet
 1 inch = 400 feet

[210173]

[FIGURE 1]

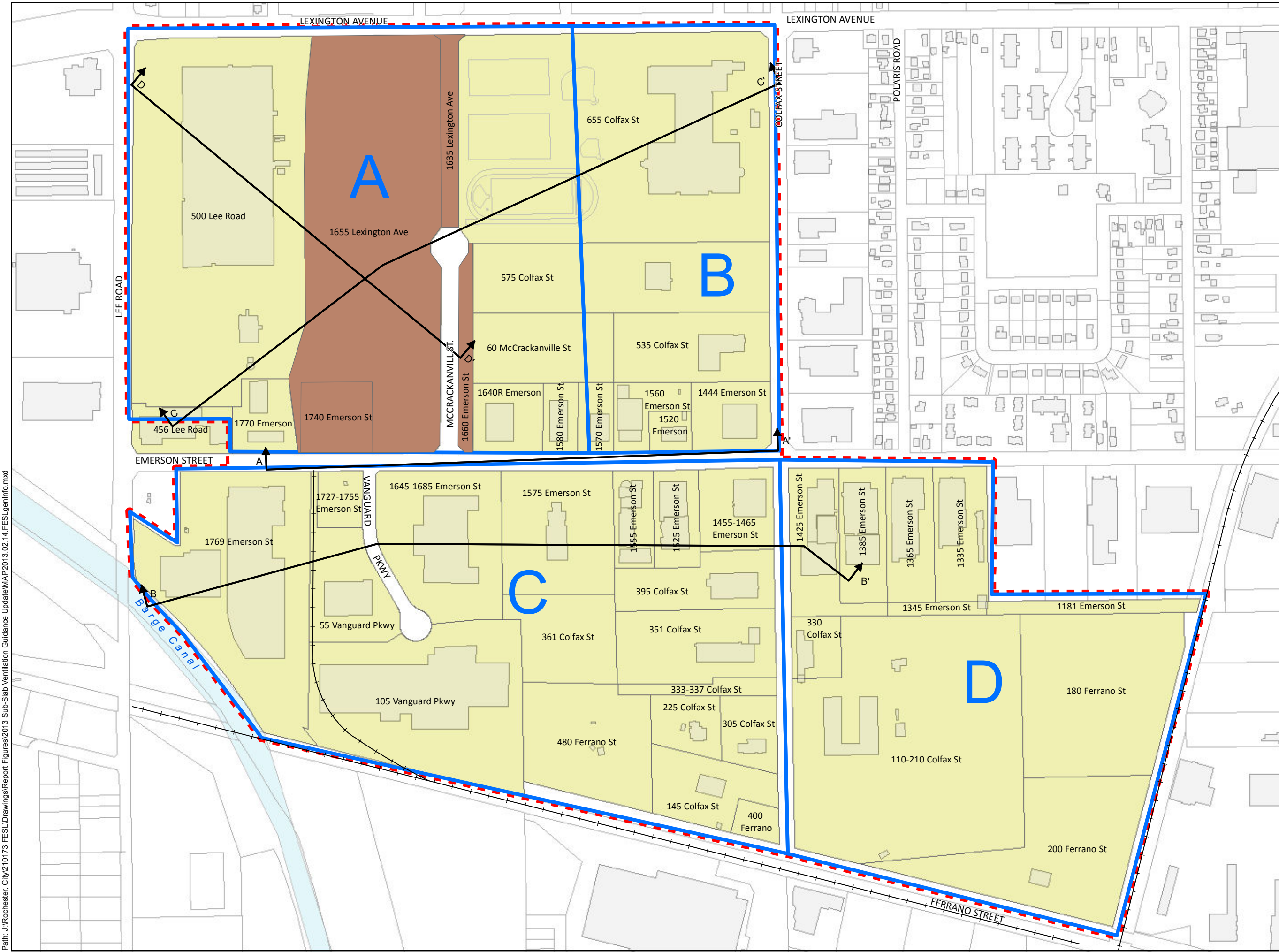

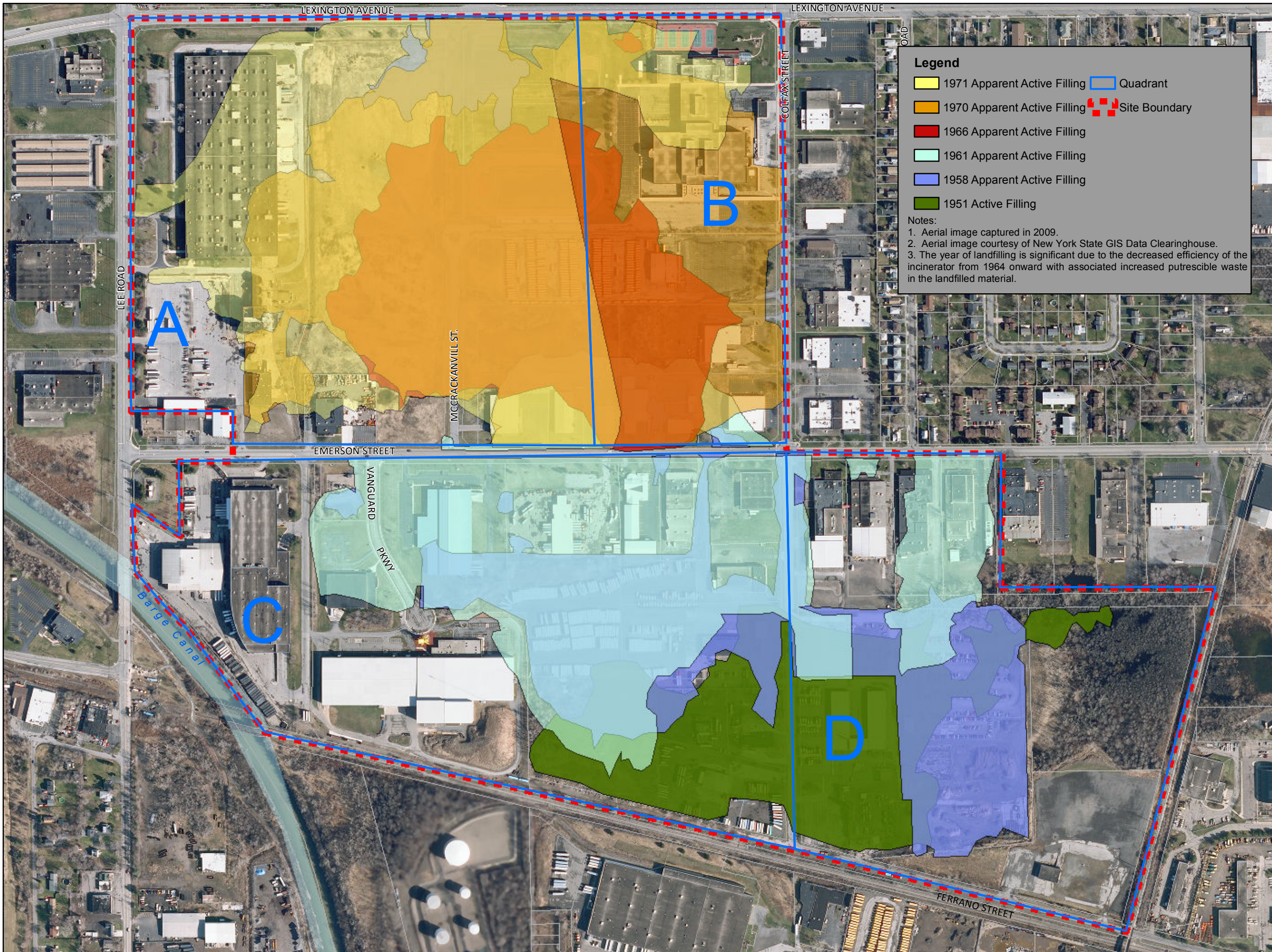

**FORMER EMERSON
STREET
LANDFILL**

**SUB-SLAB VENTILATION
GUIDANCE UPDATE
2012**

CITY OF ROCHESTER

**Total Fill Footprint with
Areas of Filling Identified on
Aerial Photographs Defined
by Year**

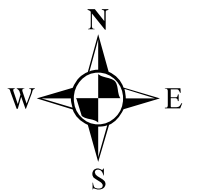

0 400 Feet
1 inch = 400 feet

Path: J:\Rochester_City\210173 FESL\Drawings\Report Figures\2013 Sub-Slab Ventilation Guidance Update\MAP 2012.10.01.Pre- and Post-1964 Landfill Deposition.mxd

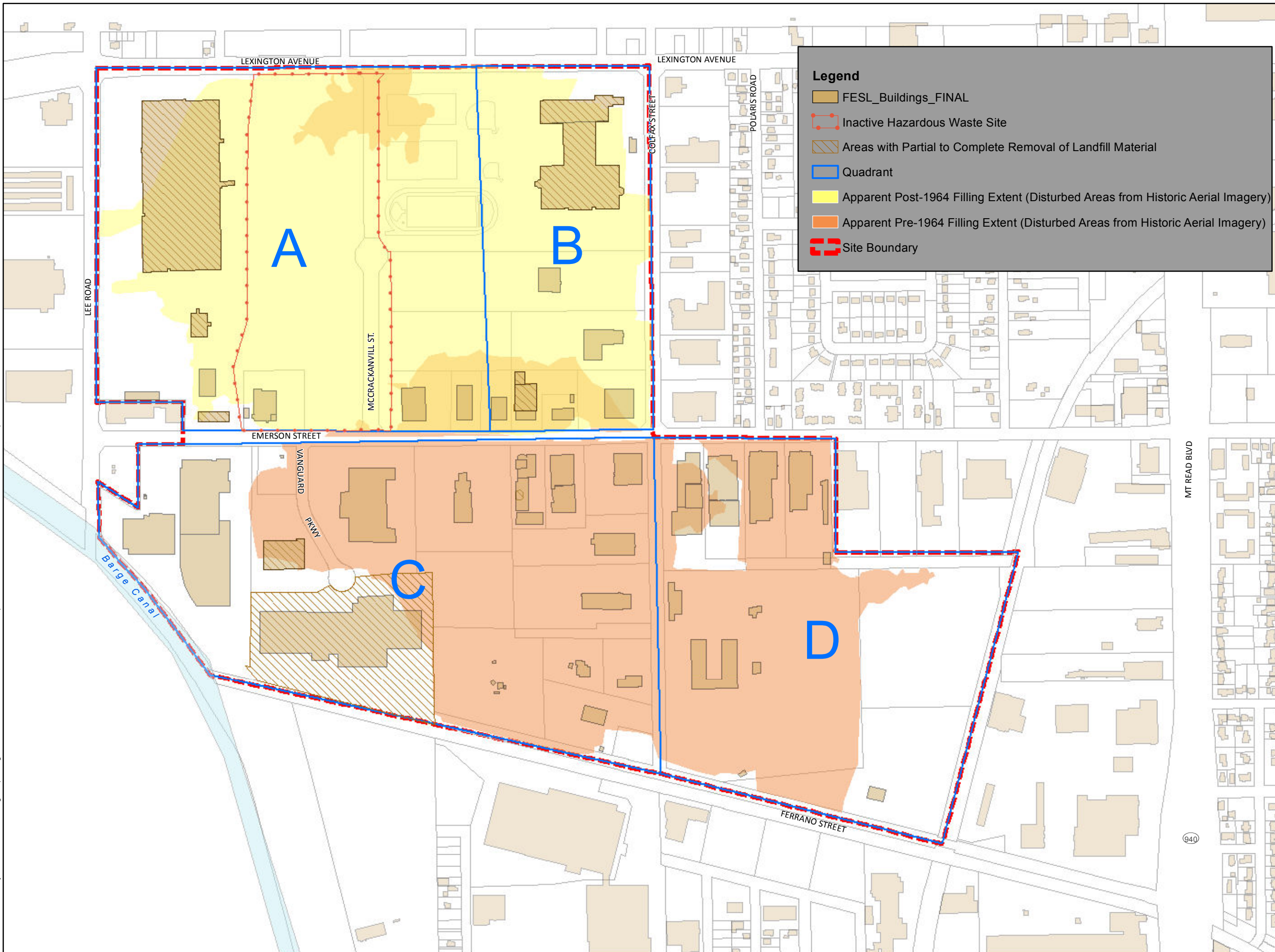

Legend

- FESL_Buildings_FINAL
- Inactive Hazardous Waste Site
- Areas with Partial to Complete Removal of Landfill Material
- Quadrant
- Apparent Post-1964 Filling Extent (Disturbed Areas from Historic Aerial Imagery)
- Apparent Pre-1964 Filling Extent (Disturbed Areas from Historic Aerial Imagery)
- Site Boundary

FORMER EMERSON STREET LANDFILL

SUB-SLAB VENTILATION GUIDANCE UPDATE 2012

CITY OF ROCHESTER

Total Fill Footprint with Areas of Filling Identified on Aerial Photographs pre-and post-1964

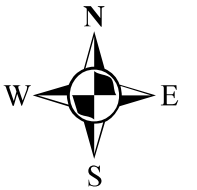

0 400 Feet
1 inch = 472 feet

[210173]
[FIGURE 3]

**FORMER EMERSON STREET
LANDFILL**

**SUB-SLAB VENTILATION
GUIDANCE UPDATE
2012**

CITY OF ROCHESTER

**Interpolated Areas of
Methane Evolution**

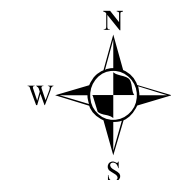

0 375 Feet
1 inch = 400 feet

[210173]
[FIGURE 4]

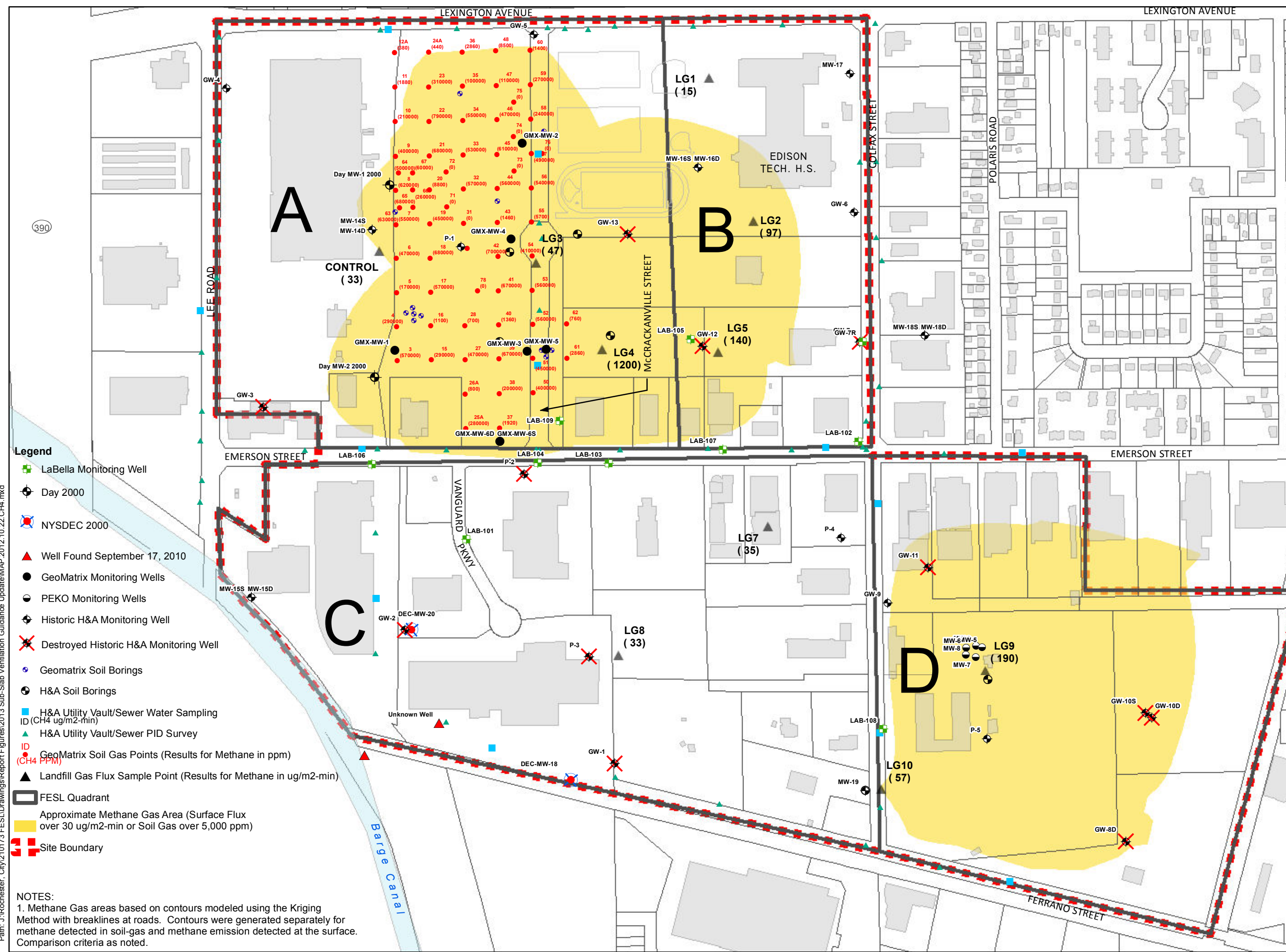

- Legend**
- LaBella Monitoring Well
 - ⊕ Day 2000
 - ⊕ NYSDEC 2000
 - ▲ Well Found September 17, 2010
 - GeoMatrix Monitoring Wells
 - ⊖ PEKO Monitoring Wells
 - ⊕ Historic H&A Monitoring Well
 - ⊕ Destroyed Historic H&A Monitoring Well
 - ⊕ Geomatrix Soil Borings
 - ⊕ H&A Soil Borings
 - ⊕ H&A Utility Vault/Sewer Water Sampling ID (CH₄ ug/m²-min)
 - ▲ H&A Utility Vault/Sewer PID Survey
 - ⊕ GeoMatrix Soil Gas Points (Results for Methane in ppm) (CH₄ PPM)
 - ▲ Landfill Gas Flux Sample Point (Results for Methane in ug/m²-min)
 - FESL Quadrant
 - Approximate Methane Gas Area (Surface Flux over 30 ug/m²-min or Soil Gas over 5,000 ppm)
 - ⊕ Site Boundary

NOTES:
1. Methane Gas areas based on contours modeled using the Kriging Method with breaklines at roads. Contours were generated separately for methane detected in soil-gas and methane emission detected at the surface. Comparison criteria as noted.

Path: J:\Rochester, City\210173 FESL\Drawings\Report Figures\2013 Sub-Slab Ventilation Guidance Update\MAP-2012-10-22 CH4.mxd

**FORMER EMERSON STREET
LANDFILL**

**SUB-SLAB VENTILATION
GUIDANCE UPDATE
2012**

CITY OF ROCHESTER

**Methane Building
Screening Results**

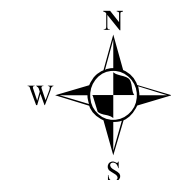

0 410 Feet
1 inch = 439 feet

Path: J:\Rochester, City\210173 FESLD\Drawings\Report Figures\2013 Sub-Slab Ventilation Guidance Update\MAP-2013.01.07.bldgCHreadings.mxd

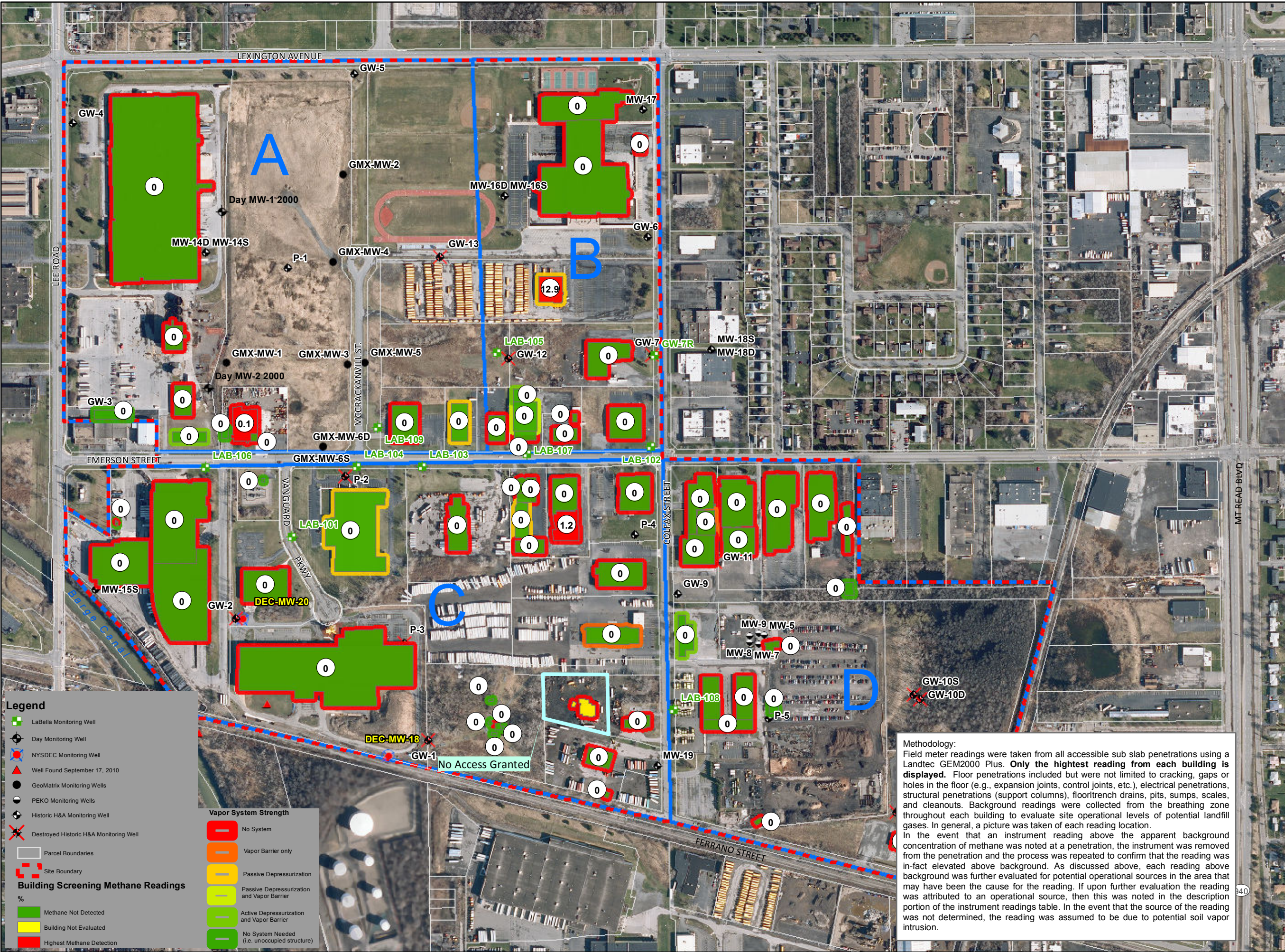

Legend

- LaBella Monitoring Well
- Day Monitoring Well
- NYSDEC Monitoring Well
- Well Found September 17, 2010
- GeoMatrix Monitoring Wells
- PEKO Monitoring Wells
- Historic H&A Monitoring Well
- Destroyed Historic H&A Monitoring Well
- Parcel Boundaries
- Site Boundary

Building Screening Methane Readings

- Methane Not Detected
- Building Not Evaluated
- Highest Methane Detection

Vapor System Strength

- No System
- Vapor Barrier only
- Passive Depressurization
- Passive Depressurization and Vapor Barrier
- Active Depressurization and Vapor Barrier
- No System Needed (i.e. unoccupied structure)

Methodology:
Field meter readings were taken from all accessible sub slab penetrations using a Landtec GEM2000 Plus. **Only the highest reading from each building is displayed.** Floor penetrations included but were not limited to cracking, gaps or holes in the floor (e.g., expansion joints, control joints, etc.), electrical penetrations, structural penetrations (support columns), floor/trench drains, pits, sumps, scales, and cleanouts. Background readings were collected from the breathing zone throughout each building to evaluate site operational levels of potential landfill gases. In general, a picture was taken of each reading location. In the event that an instrument reading above the apparent background concentration of methane was noted at a penetration, the instrument was removed from the penetration and the process was repeated to confirm that the reading was in-fact elevated above background. As discussed above, each reading above background was further evaluated for potential operational sources in the area that may have been the cause for the reading. If upon further evaluation the reading was attributed to an operational source, then this was noted in the description portion of the instrument readings table. In the event that the source of the reading was not determined, the reading was assumed to be due to potential soil vapor intrusion.

**FORMER EMERSON
STREET
LANDFILL**

**SUB-SLAB VENTILATION
GUIDANCE UPDATE
2013**

CITY OF ROCHESTER

**CVOCs IN GROUNDWATER
WITH GROUNDWATER
CONTOURS**

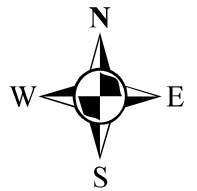

1 inch = 400 feet

[210173]
[FIGURE 6]

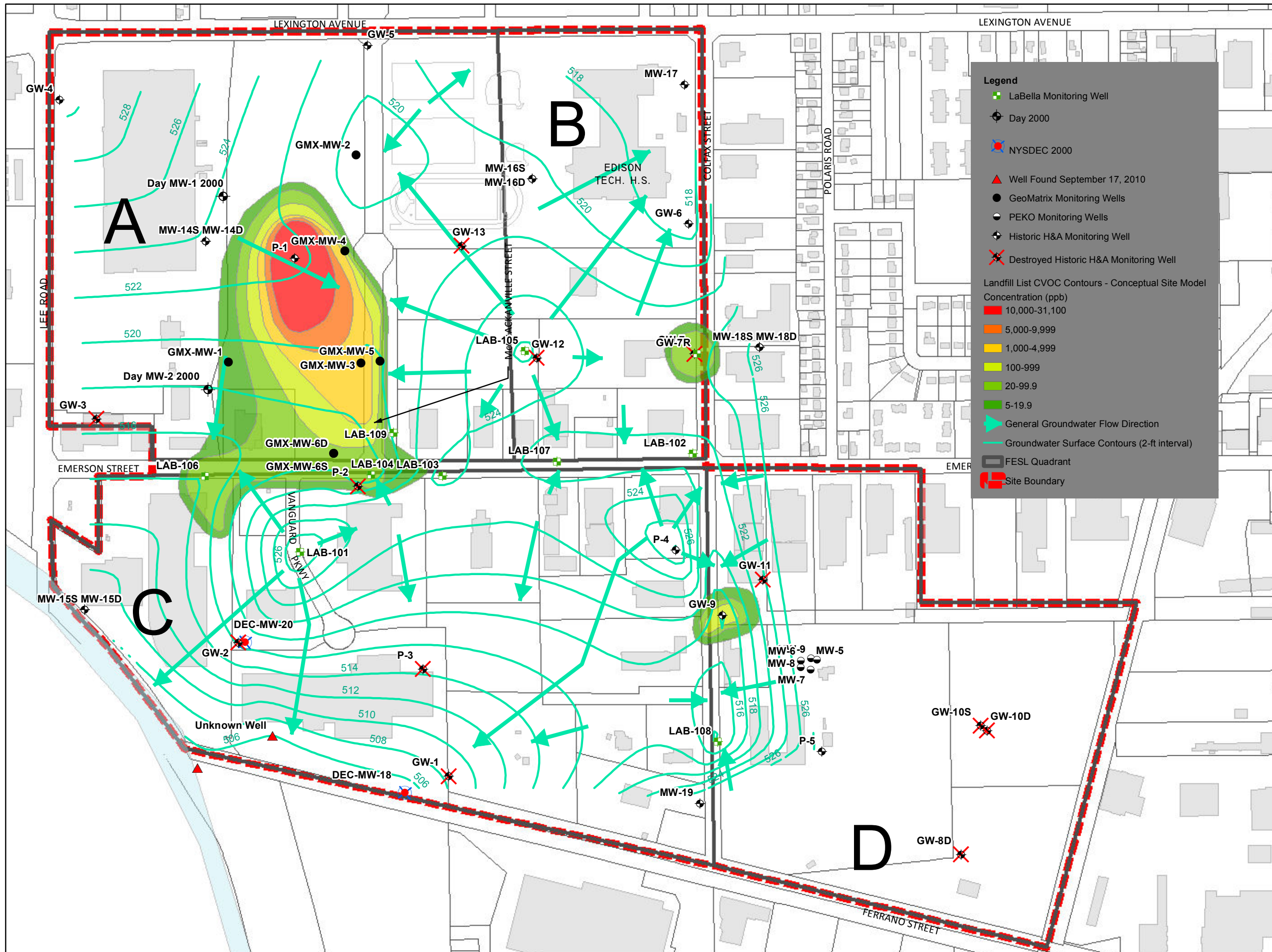

Legend

- LaBella Monitoring Well
- ⊕ Day 2000
- ⊕ NYSDEC 2000
- ▲ Well Found September 17, 2010
- GeoMatrix Monitoring Wells
- ⊖ PEKO Monitoring Wells
- ⊕ Historic H&A Monitoring Well
- ⊕ Destroyed Historic H&A Monitoring Well

Landfill List CVOC Contours - Conceptual Site Model
Concentration (ppb)

- 10,000-31,100
- 5,000-9,999
- 1,000-4,999
- 100-999
- 20-99.9
- 5-19.9

- ▶ General Groundwater Flow Direction
- Groundwater Surface Contours (2-ft interval)
- ▭ FESL Quadrant
- ▭ Site Boundary

Path: J:\Rochester_City\210173 FESL\Drawings\Report Figures\2013 Sub-Slab Ventilation Guidance Update\MAP_2013.02.11.CVOCinGW.mxd

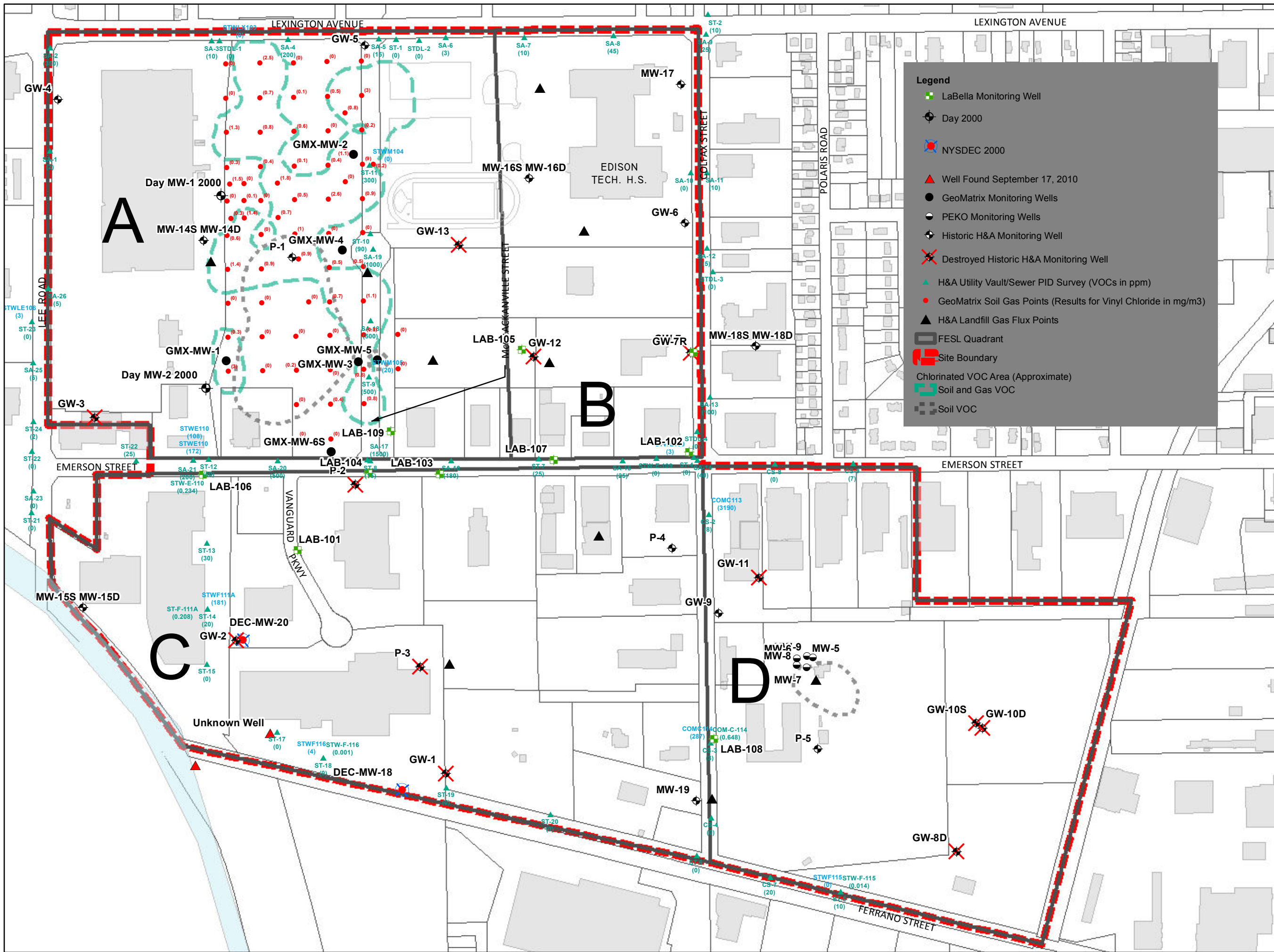

FORMER EMERSON STREET LANDFILL

SUB-SLAB VENTILATION GUIDANCE UPDATE 2013

CITY OF ROCHESTER

CVOCs IN SOIL AND SOIL VAPOR

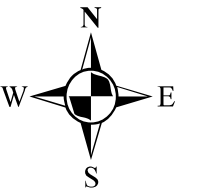

1 inch = 400 feet

[210173]

[FIGURE 7]

Legend

- LaBella Monitoring Well
- ⊕ Day 2000
- NYSDEC 2000
- ▲ Well Found September 17, 2010
- GeoMatrix Monitoring Wells
- PEKO Monitoring Wells
- ⊕ Historic H&A Monitoring Well
- ✕ Destroyed Historic H&A Monitoring Well
- ▲ H&A Utility Vault/Sewer PID Survey (VOCs in ppm)
- GeoMatrix Soil Gas Points (Results for Vinyl Chloride in mg/m3)
- ▲ H&A Landfill Gas Flux Points
- FESL Quadrant
- Site Boundary
- Chlorinated VOC Area (Approximate)
- Soil and Gas VOC
- Soil VOC

FORMER EMERSON STREET LANDFILL
SUB-SLAB VENTILATION GUIDANCE UPDATE 2012
CITY OF ROCHESTER

Historic Test Locations with Regulated Solid Waste (RSW) Limitis and Isopleths

Legend

- Major (5' Interval)
- - - Minor (1' Interval)

Areas with Partial to Complete Removal of RSW

- Blue Shaded Area: Incomplete Removal
- Purple Shaded Area: Complete Removal

Historing Test Locations

- ◆ Locations Included in RSW Model (RSW Thickness [ft])
- ◇ Locations excluded from RSW Model

□ Building

▭ Parcel Boundary

▭ Quadrant

▭ Site Boundary

Note:

1) Borings at 180 Ferrano Street encountered ash material; however, this property was developed prior to 1930 and there were no disturbed areas associated with the Former Emerson Street Landfill on the aerials reviewed (refer to Figures 4a through 4g).

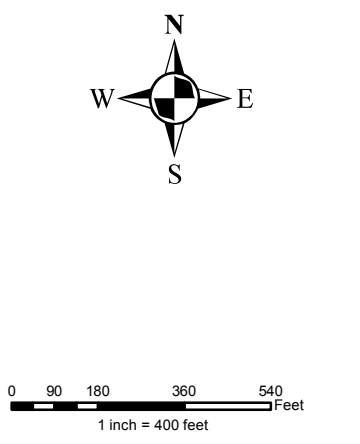
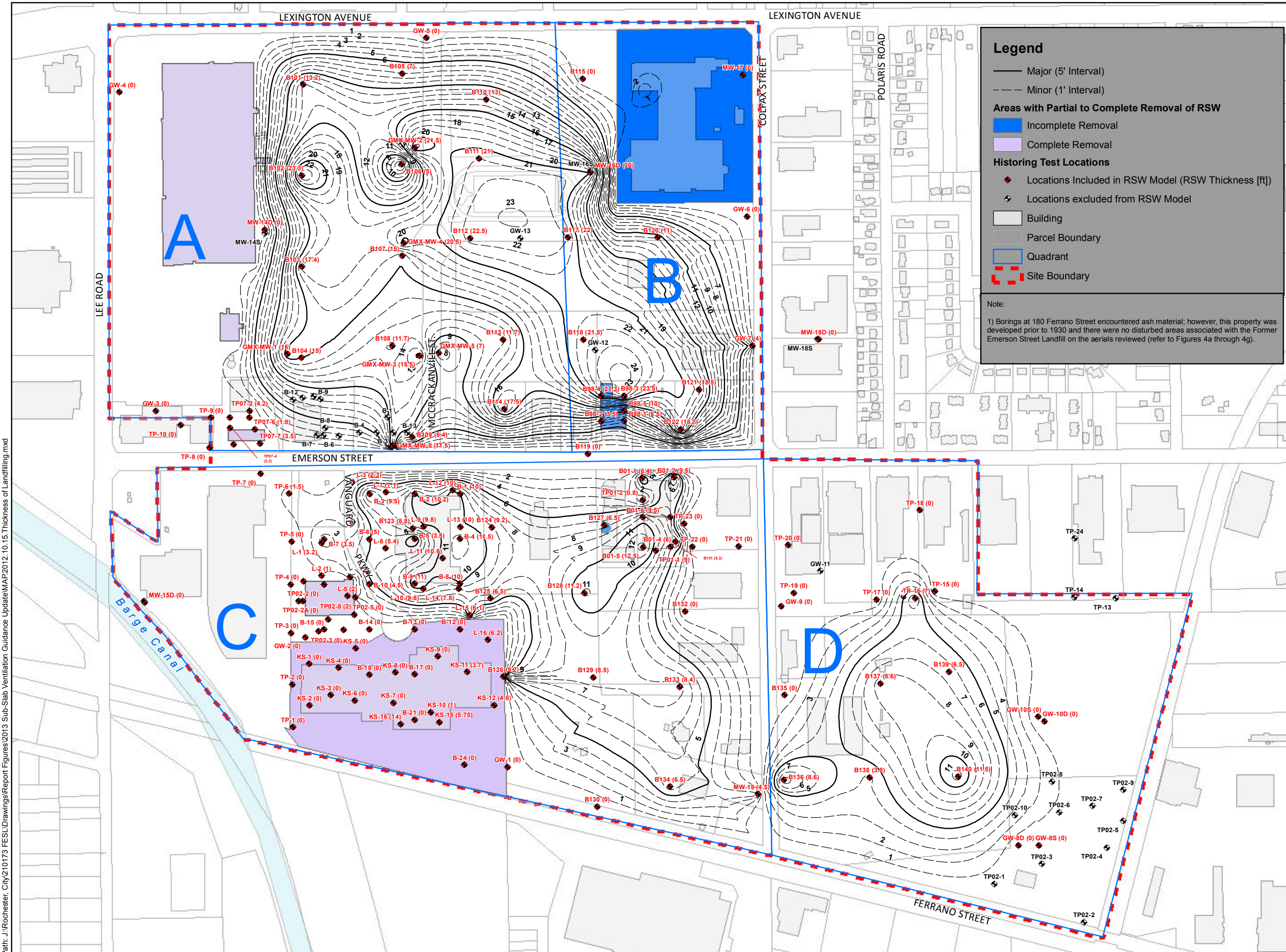

210173

FIGURE 8

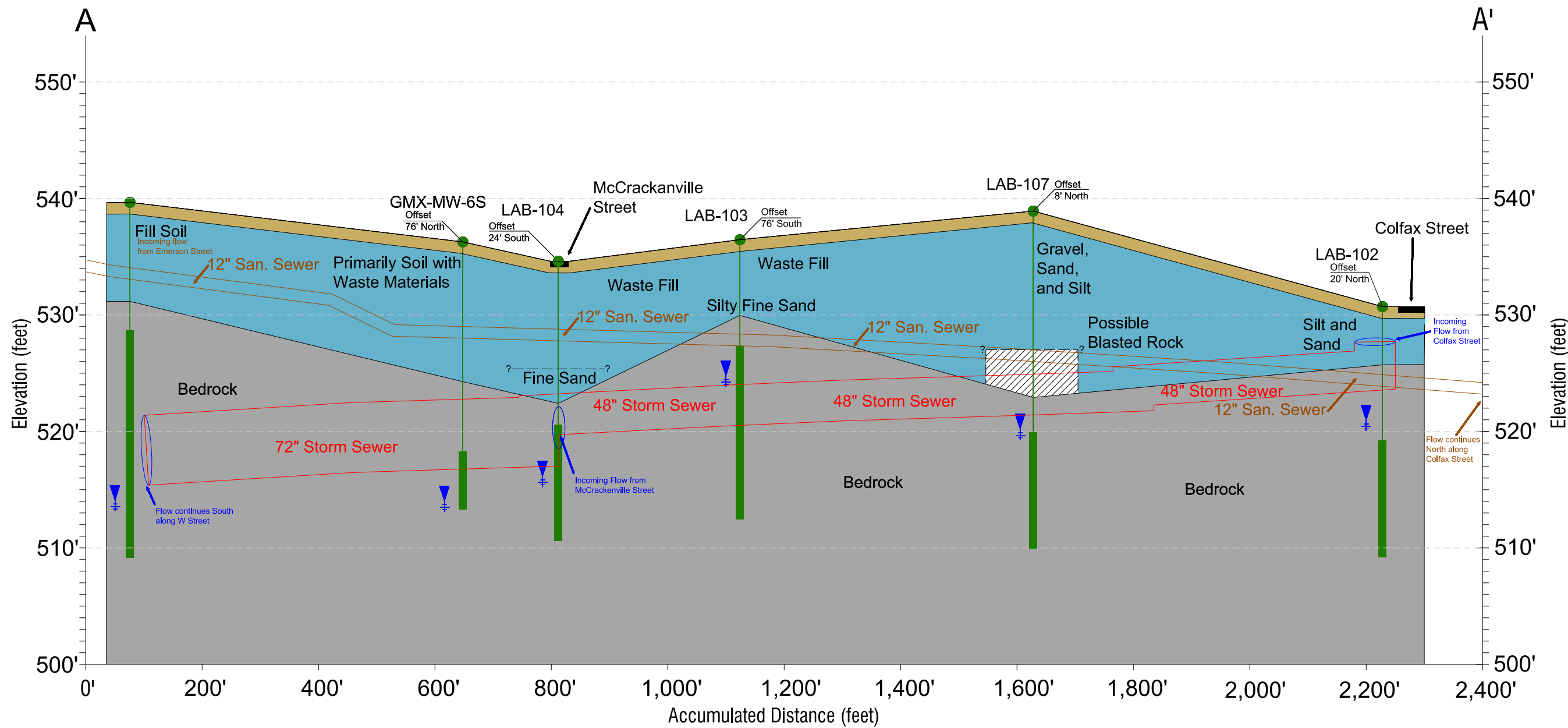







CROSS SECTION
A-A'

NOTE:

1. Formations based on boring log notes.
2. Subsurface formations inferred in areas below the terminal depth of borings, beyond the first and last point, and areas between borings.
3. Water Levels measured on December 2010.
4. All elevations are in NGVD 29 vertical datum.
5. All fill descriptors were interpreted from boring logs.
6. Sewer invert elevations were obtained from Monroe County Mile Square maps.

LEGEND

	Topsoil/Surface Treatment		30.0' Depth to Well
	Fill		Groundwater Elevation
	Bedrock		Monitoring Well
			(Screened Interval)

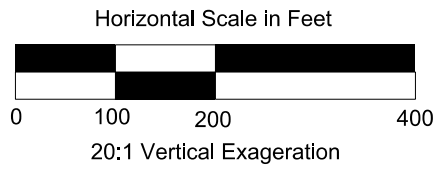

[210173]
[FIGURE 9]

FORMER EMERSON STREET
LANDFILL
SUB-SLAB VENTILATION
GUIDANCE UPDATE
2012
CITY OF ROCHESTER

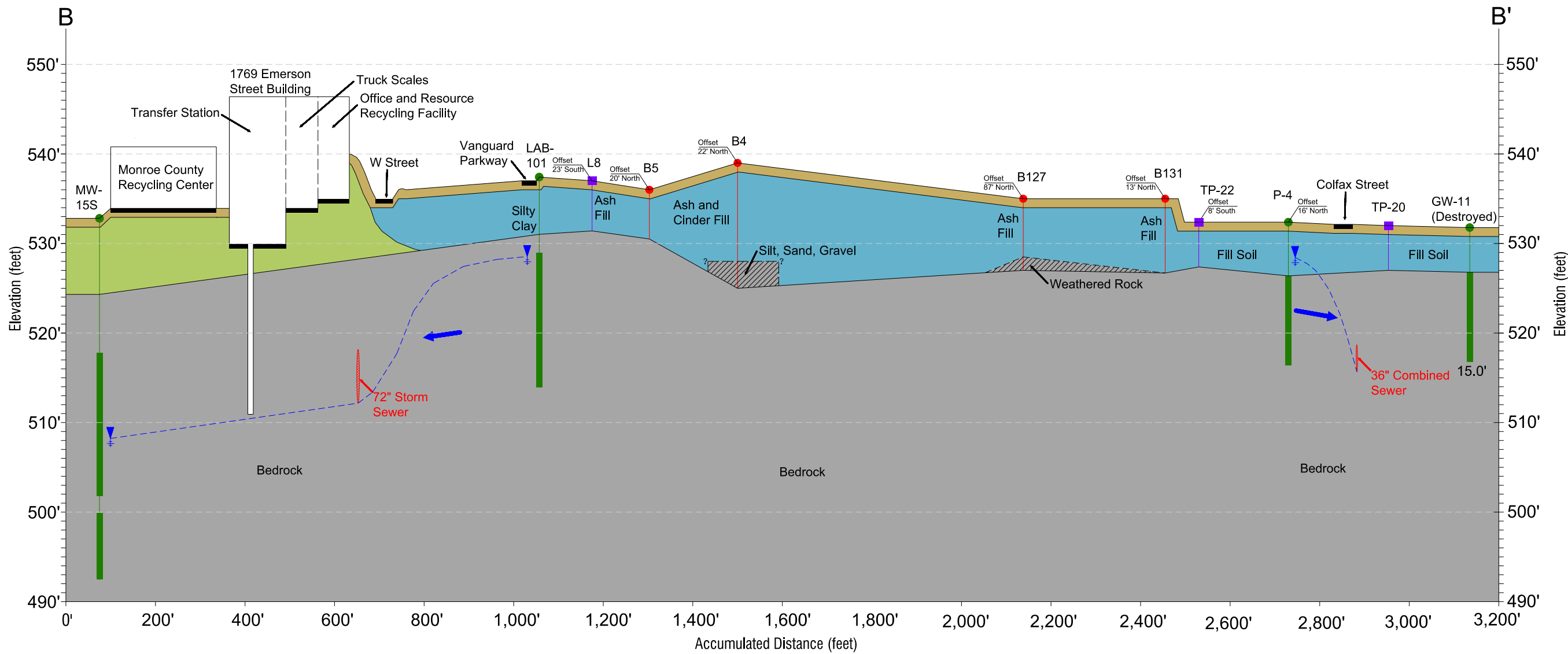

CROSS SECTION
B-B'

NOTE:
1. Formations based on boring log notes.
2. Subsurface formations inferred in areas below the terminal depth of borings, beyond the first and last point, and areas between borings.
3. Water Levels measured on December 2010.
4. All elevations are in NGVD 29 vertical datum.
5. Ground surface elevations for all test borings and test pits are inferred, based upon field observation. These features were not surveyed.
6. All fill descriptors were interpreted from boring logs.
7. Sewer invert elevations were obtained from Monroe County Mile Square maps.

LEGEND

Topsoil/Surface Treatment	30.0' Depth to Well Groundwater Flow Path
Fill	Groundwater Elevation
Re-Worked or Native Soils (i.e. No Regulated Solid Waste)	Monitoring Well ← (Screened Interval)
Bedrock	Test Boring
	Test Pit

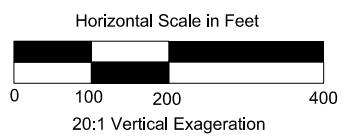

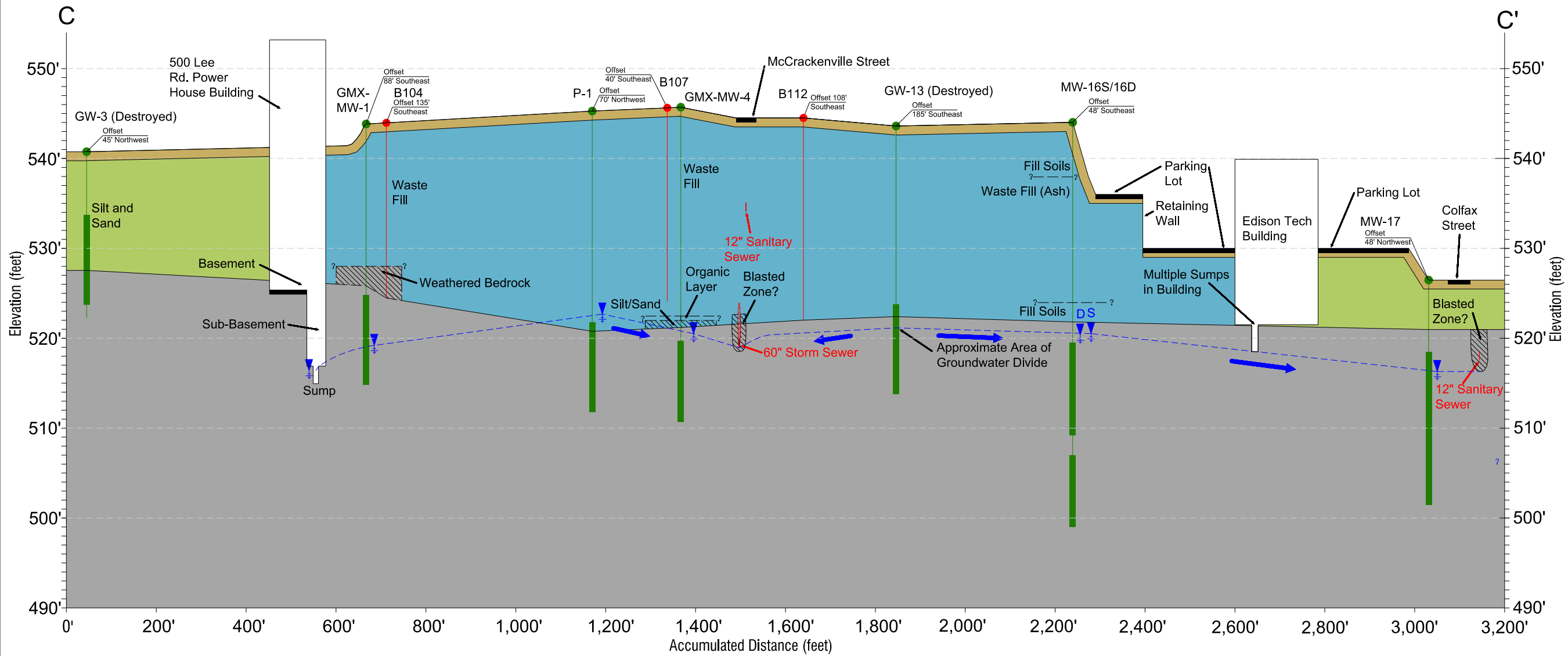

CROSS SECTION
C-C'

NOTE:
 1. Formations based on boring log notes.
 2. Subsurface formations inferred in areas below the terminal depth of borings, beyond the first and last point, and areas between borings.
 3. Water Levels measured on December 2010.
 4. All elevations are in NGVD 29 vertical datum.
 5. Ground surface elevations for all test borings and test pits are inferred, based upon field observation. These features were not surveyed.
 6. All fill descriptors were interpreted from boring logs.
 7. Sewer invert elevations were obtained from Monroe County Mile Square maps.
 8. Edison Tech building elevations were obtained from Northrup, Kaelber, and Kopf "Plumbing Work Plan" dated December 10, 1976. The vertical datum was not listed on the plan and is assumed to be City of Rochester Datum. We thus converted this elevation to NGVD 29.

LEGEND

Topsoil/Surface Treatment	Fill	Re-Worked or Native Soils (i.e. No Regulated Solid Waste)	Bedrock	Groundwater Surface
30.0' Depth to Well	Groundwater Elevation	Monitoring Well (Screened Interval)	Test Boring	Groundwater Flow Path

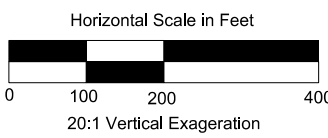



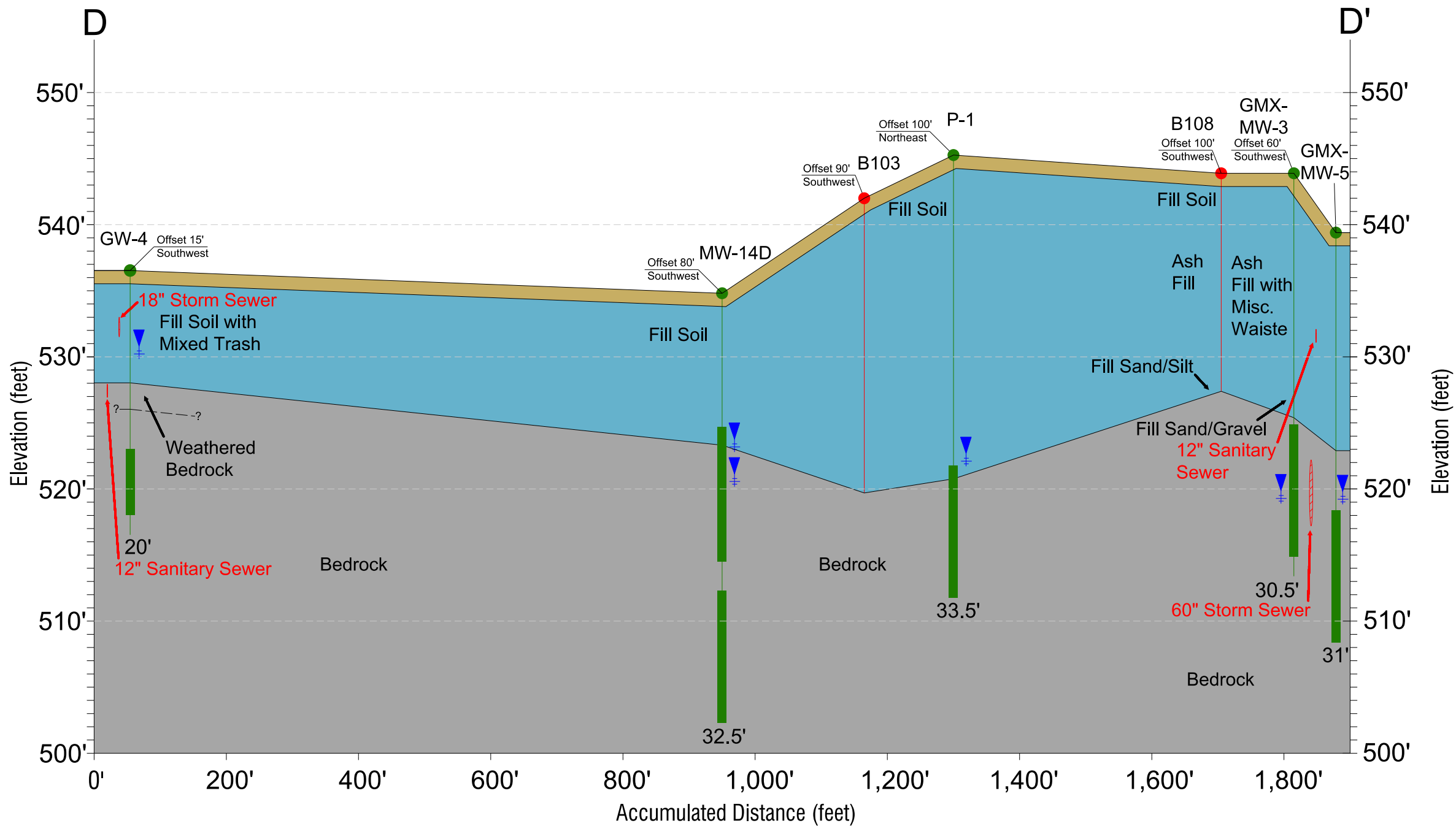





CROSS SECTION
D-D'



NOTE:

1. Formations based on boring log notes.
2. Subsurface formations inferred in areas below the terminal depth of borings, beyond the first and last point, and areas between borings.
3. Water Levels measured on December 2010.
4. All elevations are in NGVD 29 vertical datum.
5. Ground surface elevations for all test borings and test pits are inferred, based upon field observation. These features were not surveyed.
6. All fill descriptors were interpreted from boring logs.

LEGEND

	Topsoil/Surface Treatment		30.0' Depth to Well
	Fill		Groundwater Elevation
	Bedrock		Monitoring Well
			(Screened Interval)
			Test Boring

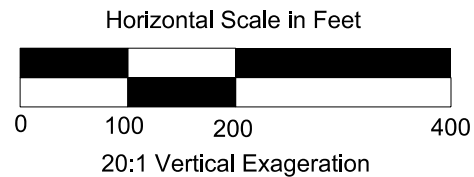

EXAMPLE BUILDING SUB-SLAB
DEPRESSURIZATION SYSTEM LAYOUT
AND TESTING POINTS - PLAN VIEW

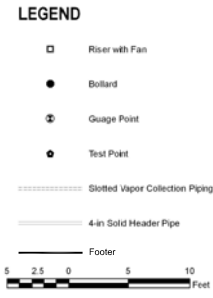
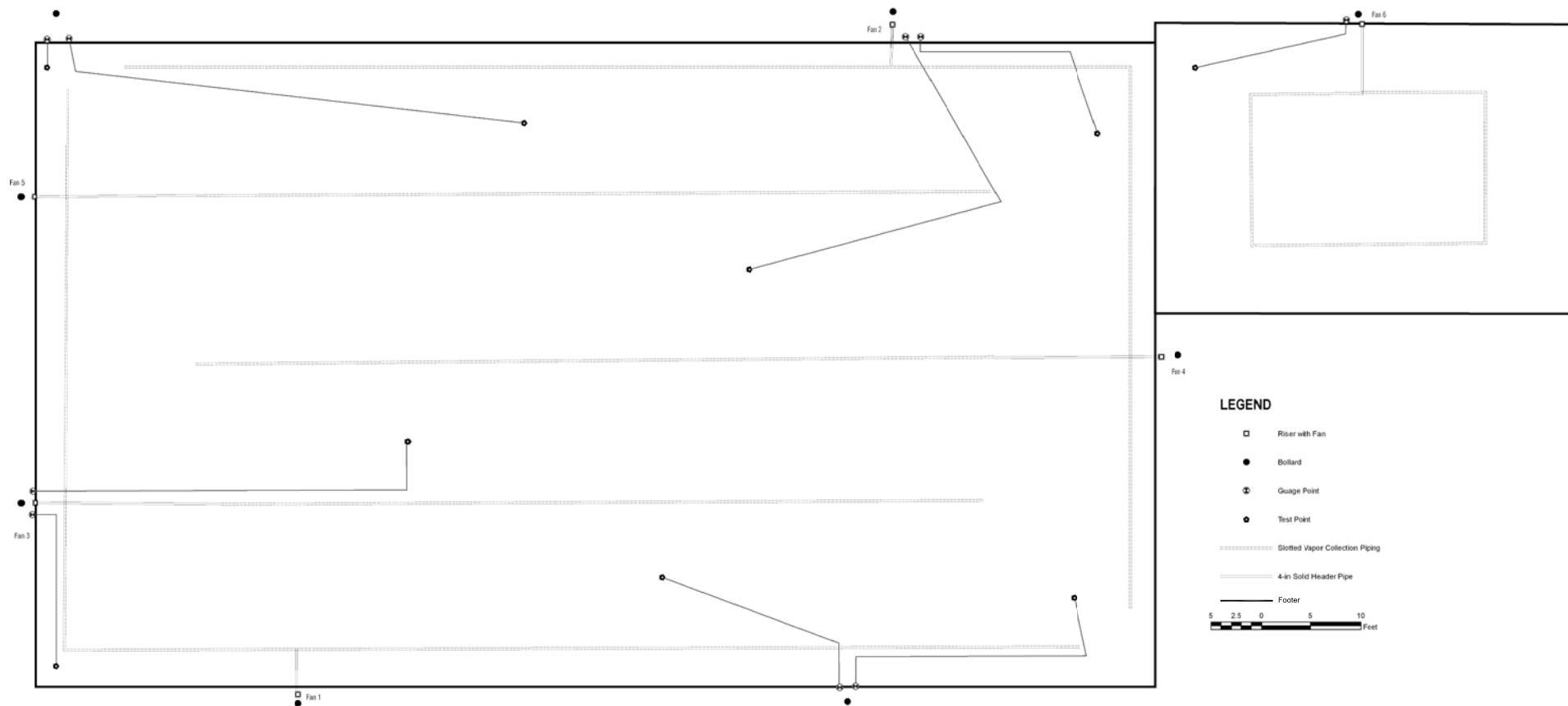

4-in Pipe Vapor Collection System

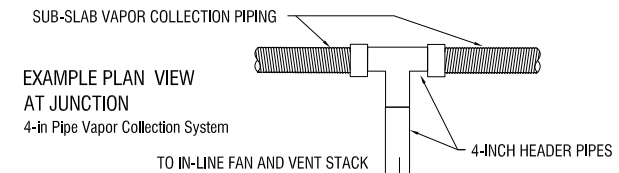

EXAMPLE CROSS-SECTIONAL
DETAIL AT TRENCH AND TEST PIPE
Type I Liner and
4-in Pipe Vapor Collection System

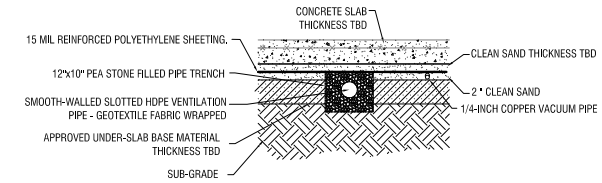

EXAMPLE EXTERIOR WALL
EXHAUST TERMINATION DETAIL
4-in Pipe Vapor Collection System



EXAMPLE FAN AND
RISER DETAIL
4-in Pipe Vapor Collection System

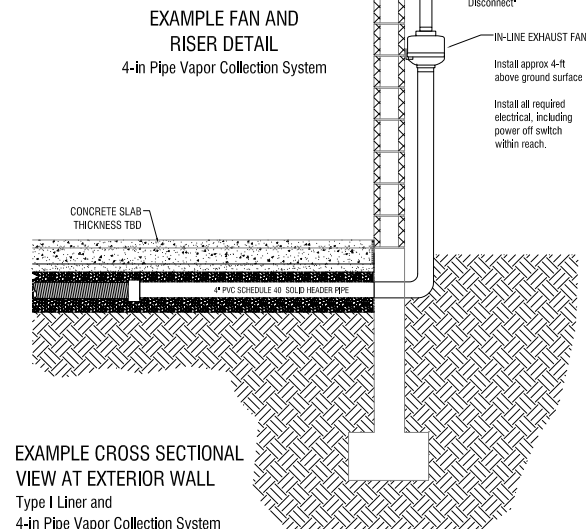

EXAMPLE CROSS SECTIONAL
VIEW AT EXTERIOR WALL
Type I Liner and
4-in Pipe Vapor Collection System

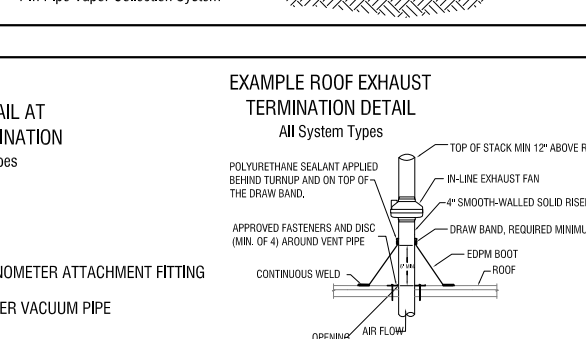

'Geovent' Type Vapor Collection System

EXAMPLE EXTERIOR WALL
EXHAUST TERMINATION DETAIL
'Geovent' Type Vapor Collection System

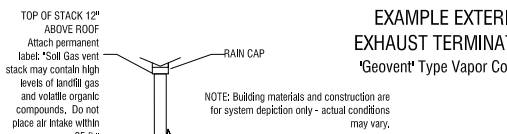

EXAMPLE FAN AND
RISER DETAIL
'Geovent' Type
Vapor Collection System

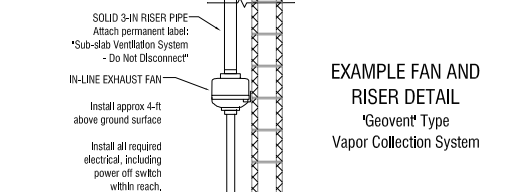

EXAMPLE CROSS SECTIONAL
VIEW AT EXTERIOR WALL
Type II Liner and
'Geovent' Type Vapor Collection System

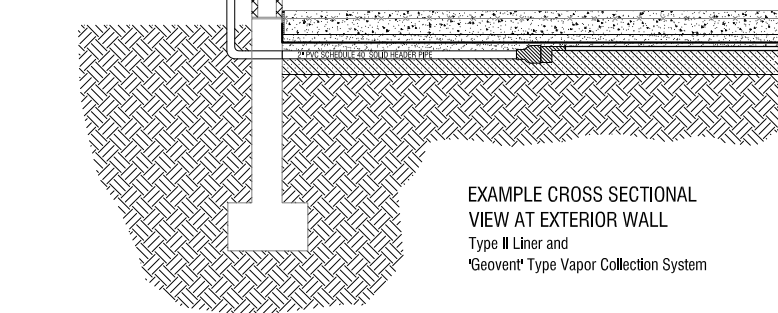

EXAMPLE CROSS-SECTIONAL
DETAIL AT TRENCH AND TEST PIPE
Type II Liner and
'Geovent' Type Vapor Collection System

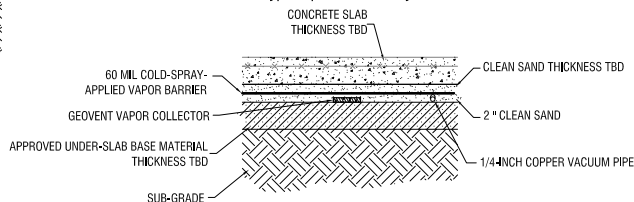

1. These drawings are for general design guidance only, and ARE NOT MEANT FOR CONSTRUCTION. Actual system design requires NYSDEC and NYSDOH approval.

2. Install perforated cap at each vapor collection pipe termination.
3. Slope header pipe up 1/4-inch per foot from connection with vapor collection piping.
4. Piping layouts may be adjusted as necessary, as long as the spacing between lengths is maintained at ~15-ft.
5. The distance from the header pipe to the end of the pipe length should not exceed 175-ft.
6. Spacing between lengths and length of pipes may be greater if geotechnical testing indicates high permeability in the upper soil horizon.
7. Areas where the slab is isolated by sub-surface foundation walls should have separate systems (see Fan 6).
8. Test points should be placed in 'worst-case' areas based on an assumed 15-ft radius of influence of each pipe.
9. Structure shown is for representation purposes only. Actual building layout and dimensions will vary.

Geovent System:

1. Install per manufacturer instructions.

4-in Pipe System:

1. All sub-slab vapor collection piping is geotextile-wrapped 4-inch perforated dual-walled corrugated exterior smooth interior HDPE.
2. Header piping shown is 4-inch schedule 40 PVC. Actual Piping may vary.

Detail Notes:

1. Profile sequence may change based on materials specified by the slab designer. Any alterations to the depicted profile that reduces the layer of permeable material shall be made in coordination with NYSDEC & MCDOH.
2. CLEAN SAND shall be bedding/cushion sand as specified in NYS DOT Section 703-06.
3. PEA STONE shall consist of material that will pass through a 2-inch sieve and be retained by a 1/4-inch sieve.
4. To protect the vapor barrier, all penetrations made after pouring of the slab, such as joints, etc., shall be cut in a manner to avoid penetrating the protective sand layer above the vapor barrier.
5. Seal all penetrations and gaps with an elastomeric joint sealant.
6. Type II liners need not be paired with 'Geovent' ventilation systems as shown. 4-in pipe or Geovent may be used interchangeably with either liner type.

EXAMPLE DETAIL AT
TEST PIPE TERMINATION
All System Types

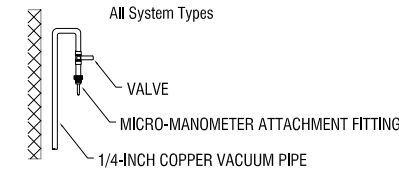

EXAMPLE ROOF EXHAUST
TERMINATION DETAIL
All System Types

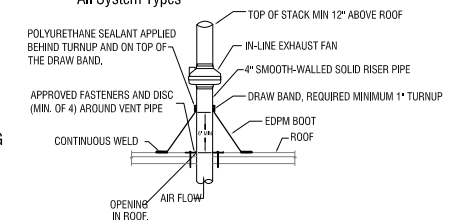

300 STATE STREET
ROCHESTER, NY 14614
P: (585) 454-6110
F: (585) 454-3066
www.labelappc.com

LABELLA
Associates, P.C.

PROJECT/CITY: CITY OF ROCHESTER
FORMER EMERSON STREET LANDFILL
ROCHESTER, NEW YORK

DRAWING TITLE: GUIDANCE FOR SUB-SLAB DEPRESSURIZATION SYSTEM DETAILS

ISSUED FOR: DRAFT

DESIGNED BY: RCM
DRAWN BY: RCM
REVIEWED BY: DEP

DATE: FEB 2013

PROJECT/DRAWING NUMBER: 207292

FIGURE 13

EXAMPLE PARKING LOT VENT SYSTEM
PLAN VIEW

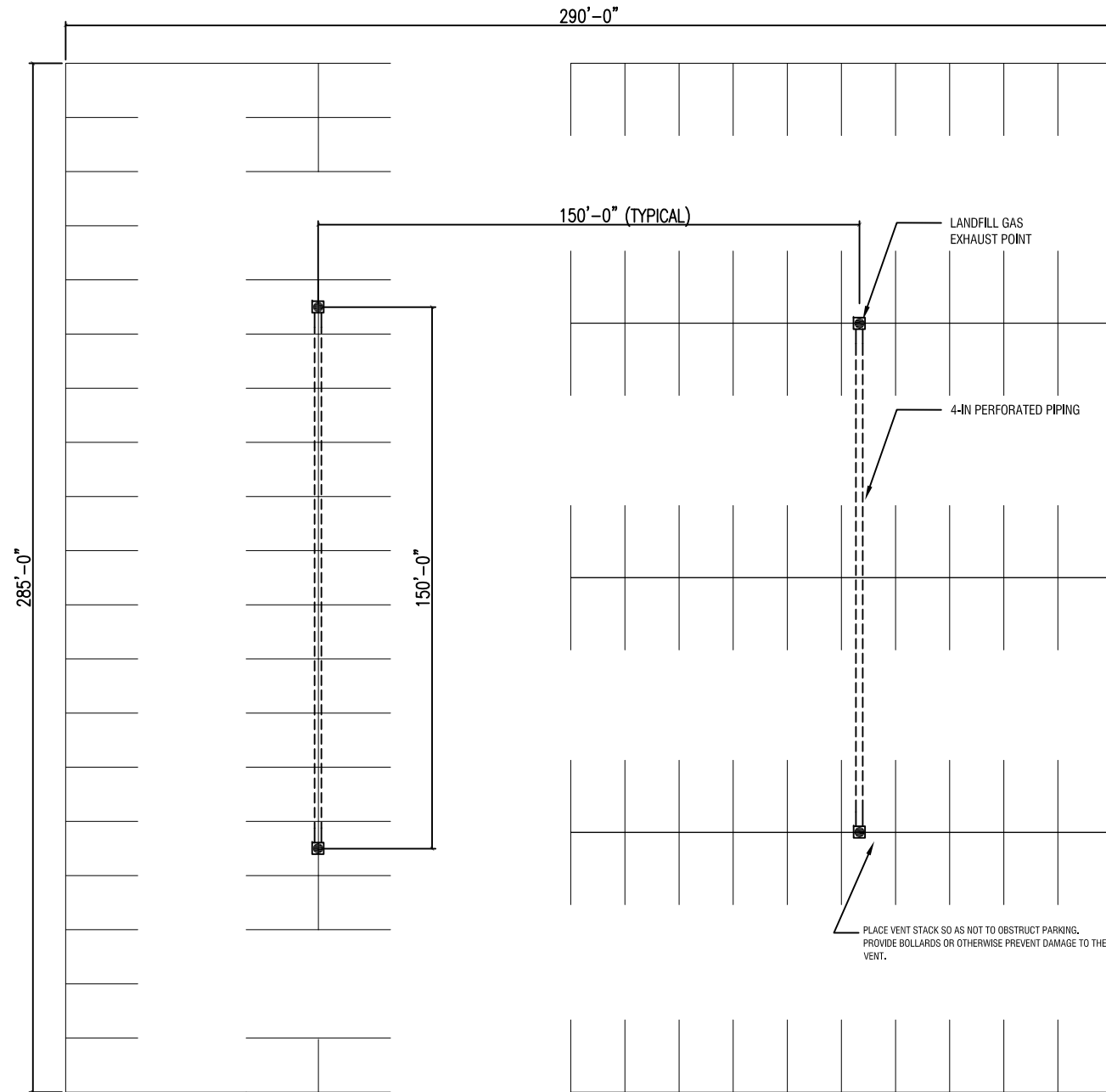

- NOTES:
1. Profile sequence may change based on materials specified by the designer. Any alterations to the depicted profile that reduces the layer of permeable material shall be made in coordination with NYSDEC & NYSDOH.
 2. PEA STONE shall consist of material that will pass through a 2-inch sieve and be retained by a 1/4-inch sieve.

PARKING LOT VENT SYSTEM
EXHAUST TERMINATION DETAIL

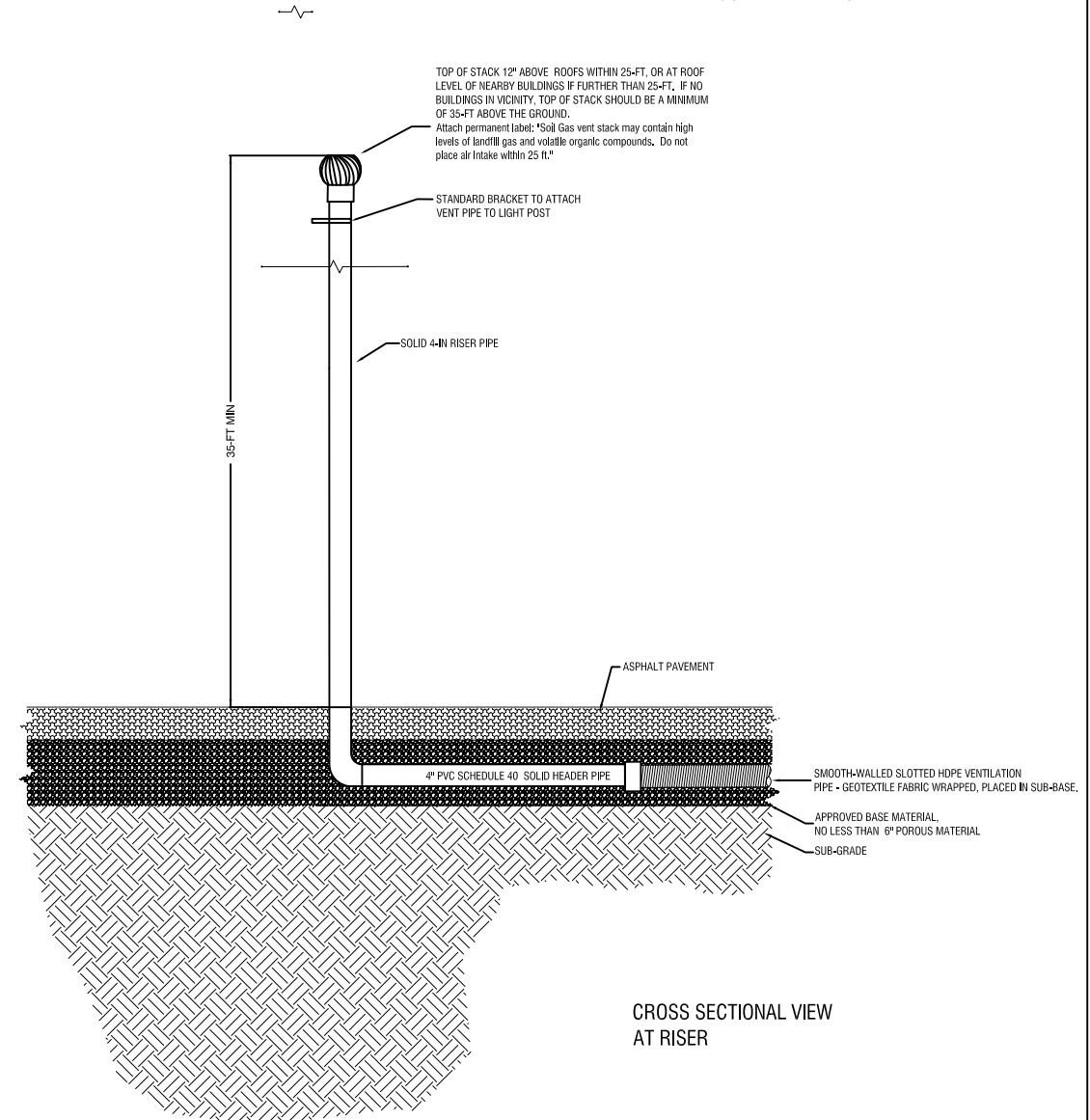

CROSS SECTIONAL VIEW
AT RISER

300 STATE STREET
ROCHESTER, NY 14614
P: (585) 454-6110
F: (585) 454-3066
www.labellapc.com

LABELLA

Associates, P.C.

Copyright © 2004

PROJECT/CLIENT
CITY OF ROCHESTER
FORMER EMERSON STREET LANDFILL
ROCHESTER, NEW YORK

DRAWING TITLE
GUIDANCE FOR PARKING LOT
VENT SYSTEM

ISSUED FOR:	DESIGNED BY:	DATE:
DRAFT	RCN	FEB 2013
	DRAWN BY:	REVIEWED BY:
	RCN	DEP

PROJECT/DRAWING NUMBER
210173

FIGURE 14

LABELLA
LaBella Associates, P.C.

300 State Street
Rochester, New York 14614

Appendix 1

SUB SLAB VAPOR SYSTEM

A. Vapor Barrier

1. TYPE I BARRIER

- i. A minimum 15-mil polyethylene or approved equivalent flexible sheeting material shall be placed prior to pouring the slab or placing the floor assembly to serve as a soil-gas-barrier by bridging any cracks that develop in the slab or floor assembly. The sheeting should cover the entire floor area, and separate sections of sheeting should be overlapped at least 12 inches. The sheeting shall be sealed around any pipe, wire or other penetrations of the material, per the manufacturer's instructions. All punctures or tears in the material repaired according to the manufacturer's instructions. The sheeting shall meet the following requirements (Stego Wrap 15-mil Class A Vapor Barrier or approved equivalent)

Property and Test

Underslab Vapor Retarders, ASTM E 1745 Class A
Water Vapor Permeance, ASTM E 96 & ASTM F 1249
Tensile Strength, ASTM D 882
Puncture Resistance, ASTM D 1709
Chemical Resistance, ASTM E 154
Life Expectancy, ASTM E 154

Performance Standard

Meet or Exceed
0.012 perms (0.006 water vapor transmission rate)
76.6 lbf./in.
2445 grams
Unaffected
Indefinite

- ii. Seams in the vapor barrier shall be sealed with a product designed to be compatible with the vapor barrier (i.e. Stego Tape for Stego Wrap products).
- iii. Follow all manufacturer's instructions (attached for Stego products, Appendix A).

2. TYPE II BARRIER

- i. A minimum 60-mil spray-applied impermeable barrier material (Liquid-Boot or approved equivalent) shall be placed prior to pouring the slab or placing the floor assembly to serve as a soil-gas-barrier by bridging any cracks that develop in the slab or floor assembly, in accordance with manufacturer's instructions. The barrier should cover the entire slab area. The barrier shall be sealed around any pipe, wire or other penetrations of the material, per the manufacturer's instructions. All punctures or tears in the material repaired according to the manufacturer's instructions.

B. Prevention of Soil-Gas Entry

- 1. All concrete floor slabs shall be designed, mixed, placed, reinforced, consolidated, finished, and cured to minimize the formation of cracks in accordance with standards set forth in the Model Building Codes.
- 2. Large openings through concrete slabs, wood, and other floor assemblies in contact with the soil, such as spaces around sanitary sewer piping, internal roof drains, shower, or toilet drains, shall be filled or closed with materials that provide a permanent airtight seal such as non-shrink mortar, grouts, expanding foam, or similar materials designed for such application.
- 3. Smaller gaps around all pipe, wire, or other objects that penetrate concrete slabs or other floor assemblies shall be made air tight with an elastomeric joint sealant, as defined in ASTM C920-87, and applied in accordance with the manufacturer's recommendations.

FORMER EMERSON STREET LANDFILL
EXAMPLE SPECIFICATIONS
NOT FOR CONSTRUCTION

October 2007

4. All control joints, isolation joints, construction joints, and any other joints in concrete slabs or between slabs and foundation walls shall be sealed. A continuous formed gap (for example, a "tooled edge") which allows the application of a sealant that will provide a continuous, airtight seal shall be created along all joints. When the slab has cured, the gap shall be cleared of loose material and filled with an elastomeric joint sealant, as defined in ASTM C920-97, and applied in accordance with the manufacturer's recommendations.
5. Joints, cracks, or other openings around all penetrations of both exterior and interior surfaces of masonry block or wood foundation walls below the ground surface shall be sealed with an elastomeric sealant that provides an air-tight seal. Penetrations of poured concrete walls should also be sealed on the exterior surface. This includes sealing of wall tie penetrations.
6. Completion is subject to owner/environmental consultant approval. The owner and environmental consultant shall be provided 24-hour notice to inspect the system.

C. Gas Collection and Vent System

1. 4-inch Pipe Type System

- i. Lengths of sub-slab vapor collection piping shall be installed beneath the vapor barrier as depicted in Figures 5 and 6. Sub-slab vapor collection piping is geotextile-wrapped 4-inch perforated dual-walled corrugated exterior smooth interior HDPE.
- ii. Vapor collection piping shall be installed in 10x12-in pipe trenches as depicted on Figure 6. Pipe trenches shall be backfilled with PEA STONE, which shall consist of material that will pass through a 2-inch sieve and be retained by a 1/4-inch sieve.
- iii. Install perforated cap at each vapor collection pipe termination, and slope header pipe up 1/4-inch per foot from connection with vapor collection piping.
- iv. The collection piping shall be connected via the appropriate fittings to 4" schedule 40 pvc header pipe. The header pipes shall penetrate the building envelope through the foundation walls, as depicted on Figure 6.

2. "Geovent" Type System

- i. Lengths of filter-fabric wrapped 3-dimensional vent core (Liquid-Boot GEOVENT or approved equivalent) should be installed beneath the sub-base as depicted in Figures 5 and 6. The vent system shall be installed in accordance with the manufacturer's instructions.
- ii. The vent shall be connected via the appropriate fittings to 2" schedule 80 pvc header pipe. The header pipes shall penetrate the building envelope through the foundation walls, as depicted on Figure 6.

3. General Requirements for Either System

- i. The header pipes shall terminate at a vertical standpipe installed attached to the exterior wall, as depicted on Figure 6. The standpipe shall terminate at least 12 inches above the surface of the roof; in a location at least 25 feet from any air intakes, at least 10 feet away from any window, air intakes, or other opening into the conditioned spaces of the building that is less than 2 feet below the exhaust point, and 10 feet from any adjoining or adjacent buildings.

**FORMER EMERSON STREET LANDFILL
EXAMPLE SPECIFICATIONS
NOT FOR CONSTRUCTION**

October 2007

- ii. All exposed and visible interior and exterior vent pipes shall be identified with at least one every 15-feet. The label shall read: "Landfill Gas Reduction System."
- iii. Vent pipes shall be installed in a configuration and supported in a manner that ensures that any rain water or condensation accumulating within the pipes drains downward into the ground beneath the vapor barrier.
- iv. Completion is subject to owner/environmental consultant approval. The owner and environmental consultant shall be provided 24-hour notice to inspect the system.
- v. It should be noted that while either gas collection type may be used with either membrane type, in the case of Liquid Boot products, the manufacturer will not sell Geovent independently of a liner.

D. Fans

- 1. Activation of the sub-slab depressurization system shall be completed by adding exhaust fans in the vertical stand pipes, as shown on Figures 5 and 6.
- 2. The fans shall meet the following requirements (in-line exhaust fans of type RadonAway GP-501 or approved equivalent):

Watts	Max Pres. "wc	Typical flow (ft3/min {cfm}) vs. static pressure (water column inches {"wc})								
		0.0" wc	0.5" wc	1.0" wc	1.5" wc	2.0" wc	2.5" wc	3.0" wc	3.5" wc	4.0" wc
60-140	4.2	-- cfm	-- cfm	95 cfm	87 cfm	80 cfm	70 cfm	57 cfm	30 cfm	10 cfm

- 3. Connection of the fans shall be coordinated with the Environmental Consultant to allow for performance testing, and explosivity testing of the vented air in each leg of the system before and during initial operation. No fans shall be activated prior to testing for explosivity.

Note: It is recommended that the explosivity testing be performed prior to the purchase of all of the designed exhaust fans. Based on the results of performance testing, the actual number of exhaust fans required to operate the system may be reduced. In addition, if the explosivity testing indicates significant levels of landfill gases, the proposed fans may not be appropriate and intrinsically safe fans may be required.

- 4. The fans in the vent pipes and all positively pressurized portions of the vent pipes shall be located outside the habitable space of the building.
- 5. The fans in the vent pipes shall be installed in vertical runs of the vent pipes, at approximately 4-feet from the ground, to facilitate maintenance and repair.

E. Warning Systems

- 1. Each vertical standpipe shall be equipped with a manometer (Vacu-Ray Vacuometer U-tube type manometer or approved equivalent) below the fan, to demonstrate that pressure within the pipe is below atmospheric pressure.

FORMER EMERSON STREET LANDFILL
EXAMPLE SPECIFICATIONS
NOT FOR CONSTRUCTION

October 2007

2. Each fan shall be equipped with a prominently positioned visible or audible warning system (WVM-93C vacuum monitor alarm or approved equivalent) to alert the building occupant if there is loss of pressure or air flow in the vent pipe, or if the fan ceases operation. Location of the warning system shall be subject to owner/environmental consultant approval.
 3. Test points consisting of an open length of copper vacuum tubing shall be installed beneath the slab as depicted on Figure 5. The vacuum tubing shall be fabric-wrapped at its sub-slab termination. The vacuum tubing shall be routed to the exterior through foundation walls, and terminate in a barbed fitting suitable for use with a magnahelic micro pressure gauge (such as the Infiltec DM-1 Digital Micro-Manometer or approved equivalent). The exterior terminations shall be mounted approximately 3-feet above the ground on the side of the building, fitted with a stop valve beneath the barbed fitting, and protected with a weather proof housing, as depicted in Figure 6.
 4. Each gauge point shall be protected by a bollard.
 5. Completion is subject to owner/environmental consultant approval. The owner and environmental consultant shall be provided 24-hour notice to inspect the system.
- F. HVAC systems shall be designed and installed to avoid depressurization of the building relative to underlying and surrounding soil. Specifically, joints in air ducts and plenums passing through unconditioned spaces shall be sealed.
- G. Completion is subject to owner/environmental consultant approval. The owner and environmental consultant shall be provided 24-hour notice to inspect the system.

Y:\Rochester, City\207392\Clerical\Word\Rpt\R7F27RN1 Final Edits 10_07.doc

LABELLA
LaBella Associates, P.C.

300 State Street
Rochester, New York 14614

Appendix 2

FINAL

**Guidance for Evaluating Soil Vapor Intrusion
in the State of New York**

October 2006

Prepared by:



NEW YORK STATE DEPARTMENT OF HEALTH
Center for Environmental Health
Bureau of Environmental Exposure Investigation

Soil Vapor Intrusion Guidance Release History

October 2006 — Current version

February 2005 — Public comment draft

Contact Information

Comments and questions on the guidance may be sent to the following:

New York State Department of Health
Bureau of Environmental Exposure Investigation
Flanigan Square, Room 300
547 River Street
Troy, New York 12180-2216

Email: BEEI@health.state.ny.us
Telephone: 1-800-458-1158, extension 27850

New York State Departments of Health and Environmental Conservation — Web Sites on Soil Vapor Intrusion

This guidance, policy documents, training documents, fact sheets, etc. are available to the public on the following web sites:

New York State Department of Health
http://www.health.state.ny.us/environmental/indoors/vapor_intrusion

New York State Department of Environmental Conservation
<http://www.dec.state.ny.us/website/der/guidance/vapor/index.html>

As new information becomes available (e.g., revisions or amendments to the guidance, new fact sheets, etc.), these web sites will be updated accordingly.

Table of Contents

	<u>Page</u>
Preface	i
Section 1: Introduction	1
1.1 Soil vapor intrusion	1
1.2 Soil vapor intrusion and human exposure	2
1.3 Factors affecting soil vapor migration and intrusion	2
1.4 Factors affecting indoor air quality	5
1.5 General approach to evaluating soil vapor intrusion	6
1.6 Conceptual site model	7
1.7 Applicability of guidance	8
1.7.1 Residential and non-residential settings	8
1.7.2 Chlorinated and non-chlorinated volatile chemical sites	8
1.7.3 Current, new and past remedial sites	8
1.8 Updates to the guidance	8
Section 2: Investigation of the Soil Vapor Intrusion Pathway	9
2.1 Sites at which an investigation is appropriate	9
2.2 Types of samples	9
2.2.1 Soil vapor	9
2.2.2 Sub-slab vapor	10
2.2.3 Crawl space air	10
2.2.4 Indoor air	10
2.2.5 Outdoor air	11
2.3 Phase of a site investigation in which to sample	11
2.4 Time of year in which to sample	12
2.4.1 Soil vapor	12
2.4.2 Buildings	12
2.5 Number of sampling rounds	13
2.6 Sampling locations	14
2.6.1 Soil vapor	14
2.6.2 Sub-slab vapor	16
2.6.3 Indoor air	16
2.6.4 Outdoor air	18
2.7 Sampling protocols	18
2.7.1 Soil vapor	19
2.7.2 Sub-slab vapor	22
2.7.3 Indoor air	24
2.7.4 Outdoor air	26
2.7.5 Tracer gas	26
2.8 Quality assurance/quality control (QA/QC)	29
2.9 Analytical methods	30
2.9.1 Subsurface vapor	30
2.9.2 Indoor air	31
2.9.3 Outdoor air	31

	<u>Page</u>
2.10 Field laboratories and mobile gas chromatographs (GCs)	31
2.11 Surveys and pre-sampling building preparation	31
2.11.1 Pre-sampling building inspection and preparation	31
2.11.2 Product inventory	33
2.12 Role of modeling.	34
Section 3: Data Evaluation and Recommendations for Action.	35
3.1 Data quality.	35
3.2 Overview.	35
3.2.1 Nature and extent of contamination in all environmental media	36
3.2.2 Factors that affect vapor migration and intrusion	36
3.2.3 Sources of volatile chemicals	36
3.2.4 Background levels of volatile chemicals in air	37
3.2.5 Relevant standards, criteria and guidance values	38
3.2.6 Completed or proposed remedial actions	40
3.2.7 Past, Current and future land uses	40
3.3 Sampling results and recommended actions	41
3.3.1 Soil vapor	41
3.3.2 Sub-slab vapor	43
3.3.3 Indoor air	45
3.3.4 Outdoor air	48
3.4 Decision matrices.	48
3.4.1 Overview	48
3.4.2 Matrices	49
3.4.3 Description of recommended actions	51
3.5 Emergency response	56
3.6 Parcels that are undeveloped or contain unoccupied buildings	56
Section 4: Soil Vapor Intrusion Mitigation	58
4.1 Methods of mitigation.	58
4.1.1 Buildings with a basement slab or slab-on-grade foundation	58
4.1.2 Buildings with a crawl space foundation	60
4.1.3 Buildings with dirt floor basements.	60
4.1.4 Buildings with multiple foundation types	60
4.1.5 Undeveloped parcels.	60
4.1.6 Additional references	60
4.2 Design and installation of mitigation systems	61
4.2.1 General recommendations.	61
4.2.2 System-specific recommendations	62
4.2.3 Technical guidance	64
4.3 Post-mitigation or confirmation testing	65
4.3.1 SSD systems with sealing	66
4.3.2 SMD systems with soil vapor retarder.	67
4.3.3 HVAC modifications	67
4.3.4 Crawl space ventilation and sealing	68
4.3.5 SVE systems designed to also mitigate exposures	68

	<u>Page</u>
4.4 Operation, maintenance and monitoring of mitigation systems	68
4.4.1 SSD and SMD systems	68
4.4.2 Other mitigation systems	69
4.4.3 Non-routine maintenance	70
4.5 Termination of mitigation system operations	70
4.6 Annual certification and notification recommendations	71
Section 5: Community Outreach	72
5.1 Site contact list	72
5.2 Project staff contact sheet	73
5.3 Fact sheets	73
5.4 Public gatherings	74
5.5 Letters transmitting results	75
5.6 Soil vapor intrusion mitigation information	76
5.7 Toll-free "800" numbers	79
5.8 Door-to-door visits	79
5.9 Document repositories	79
5.10 Medical community outreach	80
References	82
Appendices	
Appendix A: Highlights of document revisions	A-1
Appendix B: Indoor air quality questionnaire and building inventory	B-1
Appendix C: Volatile organic chemicals in air — summary of background databases.	C-1
Appendix D: NYSDOH's guidelines for chemicals in air — development overview.	D-1
Appendix E: ASTM's <i>Standard Practice for Residential Radon Mitigation</i>	E-1
Appendix F: EPA's <i>Model Standards and Techniques for Control of Radon in New Residential Buildings</i>	F-1
Appendix G: Community outreach tools — additional information	G-1
G.1 Contact List	G-2
G.2 Fact Sheet	G-6
G.3 Public Meeting	G-12
G.4 Availability Session	G-19
G.5 Toll-free "800" Numbers	G-24
G.6 Door-to-door Visits	G-26
G.7 Document Repository	G-28
Appendix H: NYSDOH fact sheets related to soil vapor intrusion	H-1

	<u>Page</u>
Tables	
Table 1.1 Environmental factors that may affect soil vapor intrusion	4
Table 1.2 Building factors that affect vapor intrusion	5
Table 1.3 Alternate sources of volatile chemicals in indoor air	6
Table 3.1 Air guideline values derived by the NYSDOH.	39
Table 3.2 General format of a decision matrix	49
Table 3.3 Volatile chemicals and their decision matrices	49
Table C1 NYSDOH 2003: Study of volatile organic chemicals in air of fuel oil heated homes.	C-6
Table C2 EPA 2001: Building assessment and survey evaluation (BASE) database, SUMMA [®] canister method	C-10
Table C3 NYSDOH 1997: Control home database	C-14
Table C4 EPA 1988: National ambient volatile organic compounds (VOCs) data base update	C-18
Table C5 Health Effects Institute 2005: Indoor, outdoor and personal air (RIOPA) data	C-20

Figures	
Figure 1.1 Generalized diagram of vapor intrusion in a residential setting from groundwater and subsurface soil sources	1
Figure 2.1 Schematic of indoor and outdoor air sampling locations	18
Figure 2.2 Schematics of a generic permanent soil vapor probe and permanent nested soil vapor probes.	20
Figure 2.3 Schematic of a generic sub-slab vapor probe	22
Figure 2.4 Schematics of generic tracer gas applications when collecting soil vapor samples.	28
Figure 5.1 Manometer indicating the SSD system is operating properly	77
Figure 5.2 Example of an illustration showing how a SSD system works	78

Inserts	
Section 3.4.2 Soil Vapor/Indoor Air Matrix 1	52
Section 3.4.2 Soil Vapor/Indoor Air Matrix 2	54

Table 1.1 Environmental factors that may affect soil vapor intrusion

Environmental Factor	Description
Soil conditions	Generally, dry, coarse-grained soils facilitate the migration of subsurface vapors and wet, fine-grained or highly organic soils retard migration.
Volatile chemical concentrations	The potential for vapor intrusion generally increases with increasing concentrations of volatile chemicals in groundwater or subsurface soils, as well as with the presence of NAPL.
Source location	The potential for vapor intrusion generally decreases with increasing distance between the subsurface source of vapor contamination and overlying buildings. For example, the potential for vapor intrusion associated with contaminated groundwater decreases with increasing depth to groundwater.
Groundwater conditions	<p>Volatile chemicals dissolved in groundwater may off-gas to the vadose zone from the surface of the water table. If contaminated groundwater is overlain by clean water (upper versus lower aquifer systems or significant downward groundwater gradients), then vapor phase migration or partitioning of the volatile chemicals is unlikely.</p> <p>Additionally, fluctuations in the groundwater table may result in contaminant smear zones. The "smear zone" is the area of subsurface soil contamination within the range of depths where the water table fluctuates. Chemicals floating on top of the water table, such as petroleum components, can sorb onto soils within this zone as the water table fluctuates. Sorption of chemicals can influence their gaseous and aqueous phase diffusion in the subsurface, and ultimately the rate at which they migrate.</p>
Surface confining layer	A surface confining layer (e.g., frost layer, pavement or buildings) may temporarily or permanently retard the migration of subsurface vapors to outdoor air. Confining layers can also prevent rainfall from reaching subsurface soils, creating relatively dry soils that further increase the potential for soil vapor migration.
Fractures in bedrock and/or tight clay soils	Fractures in bedrock and desiccation fractures in clay can increase the potential for vapor intrusion beyond that expected for the bulk, unfractured bedrock or clay matrix by facilitating vapor migration (in horizontal and vertical directions) and movement of contaminated groundwater along spaces between fractures.
Underground conduits	Underground conduits (e.g., sewer and utility lines, drains or tree roots, septic systems) with highly permeable bedding materials relative to native materials can serve as preferential pathways for vapor migration due to relatively low resistance to flow.
Weather conditions	Wind and barometric pressure changes and thermal differences between air and surrounding soils may induce pressure gradients that affect soil vapor intrusion.
Biodegradation processes	Depending upon environmental conditions (e.g., soil moisture, oxygen levels, pH, mineral nutrients, organic compounds, and temperature), the presence of appropriate microbial populations, and the degradability of the volatile chemical of concern, biodegradation in the subsurface may reduce the potential for vapor intrusion. For example, readily biodegradable chemicals in soil vapor may not migrate a significant distance from a source area while less degradable chemicals may travel farther.

Table 1.2 Building factors that may affect vapor intrusion

Building Factor	Description
Operation of HVAC systems, fireplaces, and mechanical equipment (e.g., clothes dryers or exhaust fans/vents)	Operation may create a pressure differential between the building or indoor air and the surrounding soil that induces or retards the migration of vapor-phase contaminants toward and into the building. Vapor intrusion can be enhanced as the air vented outside is replaced.
Heated building	When buildings are closed up and heated, a difference in temperature between the inside and outdoor air induces a stack effect, venting warm air from higher floors to the outside. Vapor intrusion can be enhanced as the air is replaced in the lower parts of the building.
Air exchange rates	The rate at which outdoor air replenishes indoor air may affect vapor migration into a building as well the indoor air quality. For example, newer construction is typically designed to limit the exchange of air with the outside environment. This may result in the accumulation of vapors within a building.
Foundation type	Earthen floors and fieldstone walls may serve as preferential pathways for vapor intrusion.
Foundation integrity	Expansion joints or cold joints, wall cracks, or block wall cavities may serve as preferential pathways for vapor intrusion.
Subsurface features that penetrate the building's foundation	Foundation perforations for subsurface features (e.g., electrical, gas, sewer or water utility pipes, sumps, and drains) may serve as a preferential pathway for vapor intrusion.

1.4 Factors affecting indoor air quality

Chemicals are a part of our everyday life. They are found in the household products we use and in items we bring into our homes. As such, chemicals are found in indoor air of homes not affected by intrusion of contaminated soil vapor. Examples of alternate sources of volatile chemicals in indoor air are given in Table 1.3. Similarly, volatile chemicals can be in the outdoor air that enters a home or place of business. Certain commercial and industrial facilities, such as gasoline stations and dry cleaners, and vehicle exhaust are examples of possible sources of volatile chemicals in outdoor air.

Commonly found concentrations of these chemicals in indoor and outdoor air are referred to as "background levels." These levels are generally determined from the results of samples collected in homes, offices and outdoor areas not known to be affected by external sources of volatile chemicals (for example, a home not known to be near a chemical spill, a hazardous waste site, a dry-cleaner, or a factory). Background sources of volatile chemicals are considered when conducting an investigation of the soil vapor intrusion pathway [Section 2] and when evaluating the results [Section 3].

Table 1.3 Alternate sources of volatile chemicals in indoor air

Source	Description
Outdoor air	Outdoor sources of pollution can affect indoor air quality due to the exchange of outdoor and indoor air in buildings through natural ventilation, mechanical ventilation or infiltration. Outdoor sources of volatile compounds include automobiles, lawn mowers, oil storage tanks, dry cleaners, gasoline stations, industrial facilities, etc.
Attached or underground garages	Volatile chemicals from sources stored in the garage (e.g., automobiles, lawn mowers, oil storage tanks, gasoline containers, etc.) can affect indoor air quality due to the exchange of air between the garage and indoor space.
Off-gassing	Volatile chemicals may off-gas from building materials (e.g., adhesives or caulk), furnishings (e.g., new carpets or furniture), recently dry-cleaned clothing, or areas (such as floors or walls) contaminated by historical use of volatile chemicals in a building. Volatile chemicals may also off-gas from contaminated groundwater that infiltrates into the basement (e.g., at a sump) or during the use of contaminated domestic well water (e.g., at a tap or in a shower).
Household products	Household products include, but are not limited to, cleaners, mothballs, cigarette smoke, paints, paint strippers and thinners, air fresheners, lubricants, glues, solvents, pesticides, fuel oil storage, and gasoline storage.
Occupant activities	For example, in non-residential settings, the use of volatile chemicals in industrial or commercial processes or in products used for building maintenance. In residential settings, the use of products containing volatile chemicals for hobbies (e.g., glues, paints, etc.) or home businesses. People working at industrial or commercial facilities where volatile chemicals are used may bring the chemicals into their home on their clothing.
Indoor emissions	These include, but are not limited to, combustion products from gas, oil and wood heating systems that are vented outside improperly, as well as emissions from industrial process equipment and operations.

1.5 General approach to evaluating soil vapor intrusion

Since no two sites are exactly alike, the approach to evaluating soil vapor intrusion is dependent upon site-specific conditions. A thorough understanding of the site, including its history of use, characteristics (e.g., geology, geography, identified environmental contamination, etc.) and potentially exposed populations, is used to develop an investigation plan. Existing information is reviewed to determine what data are available and what additional data should be collected (i.e., to guide the investigation). In addition, factors affecting soil vapor migration and intrusion [Section 1.3] and indoor air quality [Section 1.4] are also considered when both conducting an investigation [Section 2] and evaluating the results [Section 3].

1.7 Applicability of guidance

This guidance should be considered anywhere soil vapor intrusion is evaluated in the State of New York, whether the evaluation is being undertaken voluntarily by a corporation, a municipality, or private citizen, or under one of the state's environmental remediation programs.

1.7.1 Residential and non-residential settings

The guidance should be followed in residential and non-residential settings where people may be exposed involuntarily to chemicals from soil vapor intrusion.

1.7.2 Chlorinated and non-chlorinated volatile chemical sites

The guidance should be used when evaluating soil vapor intrusion at chlorinated and non-chlorinated volatile chemical sites, including petroleum hydrocarbon sites and manufactured gas plant sites. While the likelihood for exposures related to soil vapor intrusion may differ between sites due to site-specific conditions and chemical-specific properties, the extent of volatile chemical contamination and the nature of the contamination, these factors should be considered when developing the conceptual site model and implementing an investigation plan (as discussed in Sections 1.5 and 1.6). For example, if the conceptual site model suggests that soil vapor intrusion is not a concern at a petroleum hydrocarbon site due to biodegradation, the work plan might include the measurement of select bioparameters (e.g., oxygen, carbon dioxide, methane, etc.), along with the petroleum hydrocarbons, at varying depths to demonstrate bioattenuation in the vadose. The work plan might include sub-slab vapor sampling as well to demonstrate that conditions beneath nearby buildings are also resulting in bioattenuation of the petroleum hydrocarbons.

1.7.3 Current, new and past remedial sites

As discussed in the NYSDEC's Program Policy *DER-13: Strategy for Prioritizing Vapor Intrusion Evaluations at Remedial Sites in New York* (NYSDEC 2006), the soil vapor intrusion pathway will be evaluated at all completed, current and future remedial sites New York State. This soil vapor intrusion guidance document complements the NYSDEC's policy by providing recommendations on how to evaluate soil vapor intrusion. The combined goal of the policy and guidance documents is to conduct soil vapor intrusion evaluations as efficiently and effectively as possible at all remedial sites in New York.

1.8 Updates to the guidance

The investigation, evaluation, mitigation and remediation of soil vapor are evolving disciplines and this guidance document will be updated periodically, as appropriate. The history of the document's release is provided on the inside of the cover page. In addition, changes to the document are noted in Appendix A. The current version of the document supercedes previous versions. The current version of the guidance is available on the NYSDOH's web site (http://www.health.state.ny.us/environmental/indoors/vapor_intrusion/) or by contacting the NYSDOH's Bureau of Environmental Exposure Investigation [see Contact Information on the inside of the cover page]. Revisions or amendments to the guidance will be posted on the NYSDOH's web site.

Section 2: Investigation of the Soil Vapor Intrusion Pathway

Soil vapor is an environmental medium, like groundwater and soil, that should be characterized during the investigation of a site. This section provides guidance on collecting appropriate and relevant data that can be used to identify current or potential human exposures to contaminated subsurface vapors associated with a site. As discussed in Section 1.5, no two sites are exactly alike. Site-specific and/or building-specific conditions may warrant modifying the recommendations herein. Therefore, guidance provided in this section is presented in terms of general steps and strategies that should be applied when approaching an investigation of soil vapor intrusion.

2.1 Sites at which an investigation is appropriate

Data collected to date do not support the use of pre-determined concentrations of volatile chemicals (i.e., screening criteria) in either groundwater or soil to trigger a soil vapor intrusion investigation. Therefore, although the level of investigation may vary, the pathway should be investigated at any site with the following:

- a. an existing subsurface source (e.g., on the basis of preliminary environmental sampling) or likely subsurface source (e.g., on the basis of known previous land uses) of volatile chemicals [Section 1.1]; and
- b. existing buildings or the possibility that buildings may be constructed near a subsurface source of volatile chemicals.

2.2 Types of samples

The following are types of samples that are collected to investigate the soil vapor intrusion pathway:

- a. subsurface vapor samples:
 1. *soil vapor* samples (i.e., soil vapor samples not beneath the foundation or slab of a building) and
 2. *sub-slab vapor* samples (i.e., soil vapor samples immediately beneath the foundation or slab of a building);
- b. crawl space air samples;
- c. indoor air samples; and
- d. outdoor air samples.

The types of samples that should be collected depend upon the specific objective(s) of the sampling, as described below.

2.2.1 Soil vapor

Soil vapor samples are collected to determine whether this environmental medium is contaminated, characterize the nature and extent of contamination, and identify possible sources of the contamination. Our experience to date indicates soil vapor results alone typically cannot be relied upon to rule out sampling at nearby buildings. For example, concentrations of volatile chemicals in sub-slab vapor samples have been substantially higher (e.g., by a factor of 100 or more) than concentrations found in nearby soil vapor

samples (e.g., collected at 8 feet below grade near the building). This may be due to differences in factors such as soil moisture content and pressure gradients. Therefore, exposures are evaluated primarily based on sub-slab vapor, indoor air and outdoor air sampling results and soil vapor results are primarily used as a tool to guide these investigations.

Soil vapor sampling results are also used when evaluating the effectiveness of direct or indirect measures to remediate contaminated subsurface vapors. (Soil vapor extraction is an example of a direct remedial measure, and groundwater pumping and treating an indirect measure.)

2.2.2 Sub-slab vapor

Sub-slab vapor samples are collected to characterize the nature and extent of soil vapor contamination immediately beneath a building with a basement foundation and/or a slab-on-grade. Sub-slab vapor sampling results are used in conjunction with indoor air and outdoor air sampling results when evaluating the following:

- a. *current* human exposures;
- b. the potential for *future* human exposures (e.g., if the structural integrity of the building changes or the use of the building changes); and
- c. site-specific attenuation factors (i.e., the ratio of indoor air to sub-slab vapor concentrations).

Sub-slab vapor samples are often collected after soil vapor characterization and/or other environmental sampling (e.g., soil and groundwater characterization) indicate they are warranted. Sub-slab samples are typically collected concurrently with indoor and outdoor air samples. However, outside of the heating season, sub-slab vapor samples may be collected independently depending on the sampling objective (e.g., to characterize the extent of subsurface vapor contamination outside of the heating season to develop a more comprehensive, focused investigation plan for the heating season).

2.2.3 Crawl space air

Similar to sub-slab vapor samples, crawl space air samples are collected to characterize the nature and extent of contamination immediately beneath a building with a crawl space foundation. Crawl space air sampling results are used in conjunction with indoor air and outdoor air sampling results when evaluating the following:

- a. *current* human exposures; and
- b. the potential for *future* human exposures (e.g., if the structural integrity of the building changes or the use of the building changes).

2.2.4 Indoor air

Indoor air samples are collected to characterize exposures to air within a building, including those with earthen floors. Indoor air sampling results are used when evaluating the following:

- a. *current* human exposures;
- b. the potential for *future* exposures (e.g., if a currently vacant building should become occupied); and
- c. site-specific attenuation factors (e.g., the ratio of indoor air to sub-slab vapor concentrations).

Indoor air samples are often collected after subsurface vapor characterization and other environmental sampling (e.g., soil and groundwater characterization) indicate they are warranted. When indoor air samples are collected, concurrent sub-slab vapor, crawl space air (if applicable) and outdoor air samples are collected to evaluate the indoor air results appropriately. However, indoor air and outdoor air samples, without sub-slab vapor samples, may be collected when confirming the effectiveness of a mitigation system [Section 4].

In addition, site-specific situations may warrant collecting indoor air samples prior to characterizing subsurface vapors and/or without concurrent sub-slab vapor sampling to examine immediate inhalation hazards. Examples of such situations may include, but are not limited to, the following:

- a. in response to a spill event to qualitatively and/or quantitatively characterize the contamination;
- b. if high readings are obtained in a building when screening with field equipment (e.g., a photoionization detector (PID), an organic vapor analyzer, or an explosimeter) and the source is unknown;
- c. if significant odors are present and the source needs to be characterized; or
- d. if groundwater beneath the building is contaminated, the building is prone to groundwater intrusion or flooding (e.g., sump pit overflows), and subsurface vapor sampling is not feasible. In these situations, the collection of water samples from the sump may also be appropriate.

2.2.5 Outdoor air

Outdoor air samples are collected to characterize site-specific background outdoor air conditions. Outdoor air samples should be collected simultaneously with indoor air samples to evaluate the potential influence, if any, of outdoor air on the indoor air sampled. Outdoor air samples may also be collected concurrently with soil vapor samples to identify potential outdoor air interferences associated with infiltration of outdoor air into the sampling apparatus while the soil vapor was collected.

2.3 Phase of a site investigation in which to sample

There is no single phase (e.g., preliminary site characterization or remedial investigation) of a site investigation during which sampling to evaluate the soil vapor intrusion pathway is appropriate. Initiation of investigation activities for this specific purpose should be determined on a site-by-site basis. However, if exposures due to soil vapor intrusion appear likely at any point during the investigation, evaluation of this exposure pathway should not be delayed.

If the locations of likely source areas are reasonably known, sampling earlier during the investigation of a site rather than later is recommended because of the iterative nature of the sampling process [Section 2.5]. However, if current site conditions are not well-defined, then sampling after contamination in other environmental media (e.g., groundwater and soil) has been characterized may be considered. In the latter scenario, groundwater, soil and other site information may be used to guide an investigation of the soil vapor intrusion pathway, such as selecting locations for subsurface vapor samples based on likely migration pathways and source areas [Sections 2.6.1 and 2.6.2]. At a minimum, depth to groundwater and soil stratigraphy should be identified prior to collecting soil vapor samples.

Sampling may be delayed at parcels that are undeveloped or contain unoccupied buildings provided

- a. characterization of the parcel is not needed to
 1. address exposures in the surrounding area;
 2. design remedial measures for subsurface vapor contamination; or
 3. monitor or confirm the effectiveness of remedial measures; and
- b. measures are in place that assure that the parcel will not be developed, or buildings occupied, without addressing exposure concerns [Section 3.6].

If exposures due to soil vapor intrusion appear likely, and a delay of sampling is contemplated, the State (i.e., the NYSDEC and NYSDOH) should be informed of the contemplated delay and the rationale for the delay. Furthermore, the party contemplating the delay should consider any comments the State may have on the information provided.

2.4 Time of year in which to sample

2.4.1 Soil vapor

Soil vapor samples are collected at any time during the year. Often, sampling is completed during the summer so the results can be used as a tool when selecting buildings to be sampled during the heating season.

2.4.2 Buildings

Sub-slab vapor samples and, unless immediate sampling is appropriate, indoor air samples are typically collected during the heating season because soil vapor intrusion is more likely to occur when a building's heating system is in operation and doors and windows are closed. In New York State, heating systems are generally expected to be operating routinely from November 15th to March 31st. However, these dates are not absolute; the timeframe for sampling may vary depending on factors such as the location of the site (e.g., upstate versus downstate) and the weather conditions for a particular year.

A soil vapor intrusion investigation at a building may be conducted outside of the heating season if the concern for vapor intrusion is greater during another time of year. This may occur at certain industrial buildings, for instance, where HVAC systems are actively managed to control the ratio of recirculated indoor air to make-up air from outside the building. Information about the site and potentially affected structures, including the factors discussed in Section 1.3, should be considered in determining the timing of an investigation.

Samples may be collected at any time of year if exposures due to soil vapor intrusion appear likely. However, samples collected at times when soil vapor intrusion is not expected to have its greatest effect on indoor air quality (typically, samples collected outside of the heating season) should not be used to rule out exposures. For example, results indicating "no further action" or "monitoring required" should be verified when soil vapor intrusion is believed to be most likely to ensure these actions are protective throughout the year.

2.5 Number of sampling rounds

Investigating the soil vapor intrusion pathway usually involves more than one round of subsurface vapor, indoor air and/or outdoor air sampling, for reasons such as the following:

- a. to characterize the nature and extent of subsurface vapor contamination (similar to the delineation of groundwater contamination) and to address corresponding exposure concerns;
- b. to evaluate fluctuations in concentrations due to
 1. different weather conditions (e.g., seasonal effects),
 2. changes in building conditions (e.g., various operating conditions of a building's HVAC system),
 3. changes in source strength, or
 4. vapor migration or contaminant biodegradation processes (particularly when degradation products may be more toxic than the parent compounds); or
- c. to confirm sampling results or the effectiveness of mitigation or remedial systems.

Overall, as discussed in Section 1.5, successive rounds of sampling should be conducted until the following questions can be answered:

- a. Are subsurface vapors contaminated? If so, what are the nature and extent of contamination? What is/are the source(s) of the contamination?
- b. What are the current and potential exposures to contaminated subsurface vapors?
- c. What actions, if any, are appropriate to prevent or mitigate exposures and to remediate subsurface vapor contamination?

Toward this end, multiple rounds of sampling may be appropriate to characterize the nature and extent of subsurface vapor contamination such that

- a. both potential and current exposures are addressed [Section 2.6];
- b. measures can be designed to remediate subsurface vapor contamination, either directly (e.g., SVE system) or indirectly (e.g., soil excavation or groundwater remediation), given that monitoring and mitigation are considered temporary measures implemented to address exposures related to vapor intrusion until contaminated environmental media are remediated [Section 3.4]; and
- c. the effectiveness of remedial measures can be monitored and confirmed (e.g., endpoint sampling) [Section 4.5].

2.6 Sampling locations

The general approach for selecting sampling locations as part of a soil vapor intrusion investigation is similar to the approach for the investigation of other environmental media (e.g., soil and groundwater). Sampling locations should be selected with consideration of the conceptual site model [Section 1.6]. These locations should be selected to meet the stated objectives of the sampling program. Additionally, similar to the investigation of soil and groundwater, it is typical to start at a known or suspected source and work outward. The specific approach, however, will be dependent upon site-specific and building-specific conditions.

2.6.1 Soil vapor

If available, existing environmental data (e.g., groundwater and soil data) and site background information should be used to select locations for sampling soil vapor as part of a vapor intrusion investigation. Locations will vary depending upon surface features (e.g., presence or absence of buildings, areas of pavement, or vacant lot) and subsurface characteristics (e.g., soil stratigraphy, buried structures, utility corridors, or clay lenses), as well as the specific purpose of the sampling. Therefore, a figure illustrating proposed sampling locations (with respect to both areal position and depth), actual locations sampled in the field, and relevant on-site and off-site features should be included in all sampling work plans and reports.

Examples of how locations may vary given the specific purpose of the sampling follow. They include general guidelines that should be followed when selecting soil vapor sampling locations:

- a. to evaluate the **potential for current on-site or off-site exposures**, samples should be collected
 1. in the vicinity of a building's foundation [see special sampling consideration at the end of Section 2.6.1 if sampling around a building with no surrounding surface confining layer], as well as between the building's foundation and the source (if known and not located beneath the building),
 2. along the site's perimeter, and
 3. at a depth comparable to the depth of foundation footings (determined on a building-specific or site-specific basis) or at least 1 foot above the water table in areas where the groundwater table is less than 6 feet below grade;
- b. to evaluate the **potential for future exposures if development** on a known or suspected contaminated area on-site or off-site is possible, representative samples should be collected
 1. in areas with either known or suspected subsurface sources of volatile chemicals, in areas where elevated readings were obtained with field equipment during previous environmental investigations, and in areas of varying concentrations of contamination in the upper groundwater,
 2. in a grid pattern across the area (at an appropriate spacing interval for the size of the area) if information is limited for the area, and
 3. at multiple depths from the suspected subsurface source, or former source, to a depth comparable to the expected depth of foundation footings;

- c. to evaluate the **potential for off-site soil vapor contamination**, samples should be collected
 1. along the site's perimeter,
 2. in areas of potential subsurface sources of vapor contamination (e.g., a groundwater plume that has migrated off-site), and
 3. at a depth comparable to the depth of foundation footings (determined on a site-specific basis) or at least 1 foot above the water table in areas where the groundwater table is less than 6 feet below grade;
- d. to evaluate on-site and off-site **preferential migration pathways** in areas with low permeability soils, samples should be collected
 1. along preferential soil vapor flow paths, such as sewer lines, utility corridors, trenches, pipelines, and other subsurface structures that are likely to be bedded with higher permeability materials, and
 2. at depths corresponding to these subsurface features (will depend on site-specific conditions);
- e. to characterize on-site or off-site **contamination in the vadose zone**, samples should be collected
 1. in areas with either known or suspected sources of volatile chemicals, in areas where elevated readings were obtained with field equipment (e.g., PID) during previous soil and groundwater investigations, and in areas of varying concentrations of contamination in the upper groundwater regime, and
 2. at appropriate depths associated with these areas (will depend on site-specific conditions); and
- f. to investigate the **influence of contaminated groundwater or soil on soil vapor** and to characterize the **vertical profile** of contamination, samples should be collected from clusters of soil vapor probes at varying depths in the vadose zone [Figure 2.2, Section 2.7.1] and preferably in conjunction with the collection of groundwater or soil samples.

Soil vapor samples collected at depths shallower than 5 feet below grade may be prone to negative bias due to infiltration of outdoor air. Therefore, samples from these depths should be collected only if appropriate (based on site-specific conditions), and sampling procedures and results should be reviewed accordingly. The depth of sampling near buildings with slab-on-grade foundations is dependent upon site-specific conditions (e.g., building surrounded by grassy or surface confining layer).

When collecting soil vapor samples around a building with no surrounding surface confining layer (e.g., pavement or sidewalk), samples should be located in native or undisturbed soils away from fill material surrounding the building (approximately 10 feet away from the building) to avoid sampling in an area that may be influenced by the building's operations. For example, operation of HVAC systems, fireplaces, or mechanical equipment (e.g., clothes dryers or exhaust fans/vents) in a building may exacerbate the infiltration of outdoor air into the vadose zone adjacent to the building. As a result, soil vapor samples collected in uncovered areas adjacent to the building may not be representative.

Investigations of soil vapor contamination should proceed outward from known or suspected subsurface sources, as appropriate, on an areal basis until the nature and extent of

subsurface vapor contamination has been characterized and human exposures have been addressed.

2.6.2 Sub-slab vapor

Existing environmental data (e.g., soil vapor, groundwater and soil data), site background information, and building construction details (e.g., basement, slab-on-grade, or multiple types of foundations, HVAC systems, etc.) should be considered when selecting buildings and locations within buildings for sub-slab vapor sampling.

At a minimum, these general guidelines should be followed when selecting buildings to sample for sub-slab vapors:

- a. buildings, including residential dwellings, located above or directly adjacent to known or suspected areas of subsurface volatile chemical contamination should be sampled;
- b. buildings in which screening with field equipment (e.g., PID, ppbRAE, Jerome Mercury Vapor Analyzer, etc.) suggests a completed migration pathway, such as when readings are above background and from unidentified sources or when readings show increasing gradients, should be sampled; and
- c. buildings within known or suspected areas of subsurface volatile chemical contamination that are used or occupied by sensitive population groups (e.g., daycare facilities, schools, nursing homes, etc.) should be given special consideration for sampling.

Investigations of sub-slab vapor and/or indoor air contamination should proceed outward from known or suspected sources, as appropriate, on an areal basis until the nature and extent of subsurface vapor contamination has been characterized and potential and current human exposures have been addressed. In cases of widespread vapor contamination and depending upon the basis for making decisions (e.g., a "blanket mitigation" approach within a specified area of documented vapor contamination [Section 3.3.1]), a representative number of buildings from an identified study area, rather than each building, may be sampled. Prior to implementation, this type of sampling approach should be approved by State agency personnel.

Within a building, sub-slab vapor samples should be collected

- a. in at least one central location away from foundation footings, and
- b. from the soil or aggregate immediately below the basement slab or slab-on-grade.

The number of sub-slab vapor samples that should be collected in a building depends upon the number of slabs (e.g., multiple slabs-on-grade in a large warehouse) and foundation types (e.g., combined basement and slab-on-grade in a residence). At least one sub-slab vapor sample should be collected from each representative area.

2.6.3 Indoor air

Existing environmental data (e.g., soil vapor, groundwater and soil data), site background information, and building construction details (e.g., basement, slab-on-grade, or multiple types of foundations; number and operation of HVAC systems; elevator shafts; tunnels or other confined-space entry points; etc.) should be considered when selecting buildings and

locations within buildings for indoor air sampling. Indoor air samples are typically collected concurrently with sub-slab vapor and outdoor air samples [Section 2.2.4].

At a minimum, these general guidelines should be followed when selecting buildings to sample for indoor air:

- a. where sub-slab vapor samples were collected without indoor air samples, buildings in which elevated concentrations of contaminants were measured in sub-slab vapor samples should be sampled;
- b. buildings, including residential dwellings, located above or directly adjacent to known or suspected subsurface sources of volatile chemicals or known soil vapor contamination should be sampled;
- c. buildings in which screening with field equipment (e.g., PID, ppbRAE, Jerome Mercury Vapor Analyzer, etc.) suggests a completed migration pathway, such as when readings are above background and from unidentified sources or when readings show increasing gradients, should be sampled; and
- d. buildings within known or suspected areas of subsurface volatile chemical contamination that are used or occupied by sensitive population groups (e.g., daycare facilities, schools, nursing homes, etc.) should be given special consideration for sampling.

To characterize contaminant concentration trends and potential exposures, indoor air samples should be collected

- a. from the crawl space area,
- b. from the basement (where vapor infiltration is suspected, such as near sump pumps or indoor wells, or in a central location) at a height approximately three feet above the floor to represent a height at which occupants normally are seated and/or sleep,
- c. from the lowest level living space (in centrally-located, high activity use areas) at a height approximately three feet above the floor to represent a height at which occupants normally are seated and/or sleep, and
- d. if in a commercial setting (e.g., a strip mall), from multiple tenant spaces at a height approximately three feet above the floor to represent a height at which occupants normally are seated.

These locations are illustrated in Figure 2.1.

Investigations of indoor air contamination should proceed outward from known or suspected subsurface sources, as appropriate, on an areal basis until potential and current human exposures associated with soil vapor intrusion have been addressed. In cases of widespread vapor contamination and depending upon the basis for making decisions (e.g., a "blanket mitigation" approach within a specified area of documented vapor contamination), a representative number of buildings from an identified study area, rather than each building, may be sampled. Prior to implementation, this type of sampling approach should be approved by State agency personnel.

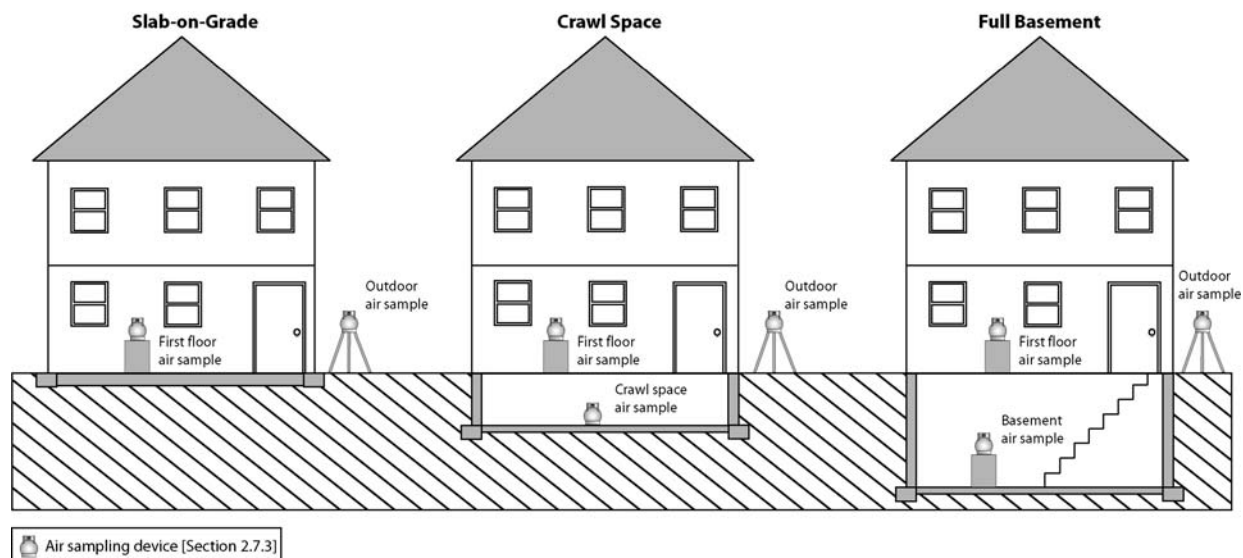

Figure 2.1
Schematic of indoor and outdoor air sampling locations

2.6.4 Outdoor air

Typically, an outdoor air sample is collected outside of each building where an indoor air sample is collected. However, if several buildings are being sampled within a localized area, representative outdoor air samples may be appropriate. For example, one outdoor air sample may be sufficient for three houses being sampled in a cul-de-sac. Outdoor air samples should be collected from a representative upwind location, away from wind obstructions (e.g., trees or bushes), and at a height above the ground to represent breathing zones (3 to 5 feet) [Figure 2.1]. A representative sample is one that is not biased toward obvious sources of volatile chemicals (e.g., automobiles, lawn mowers, oil storage tanks, gasoline stations, industrial facilities, etc.). For buildings with HVAC systems that draw outdoor air into the building, an outdoor air sample collected near the outdoor air intake may be appropriate.

2.7 Sampling protocols

The procedures recommended here may be modified depending on site-specific conditions, the sampling objectives, or emerging technologies and methodologies. Alternative sampling procedures should be described thoroughly and proposed in a work plan submitted for review by the State. The State will review and comment on the proposed procedure and consider the efficacy of the alternative sampling procedure based on the objectives of investigation. In all cases, work plans should thoroughly describe the proposed sampling procedure. Similarly, the procedures that were implemented in the field should be documented and included in the final report of the sampling results.

2.7.1 Soil vapor

Soil vapor probe installations [Figure 2.2] may be permanent, semi-permanent or temporary. In general, permanent or semi-permanent installations are preferred for data consistency reasons and to ensure outdoor air infiltration does not occur. Temporary probes should only be used if measures are taken to ensure that an adequate surface seal is created to prevent outdoor air infiltration and if tracer gas is used at every sampling location. [See Section 2.7.5 for additional information about the use of tracer gas when collecting soil vapor samples.] Soil vapor implants or probes should be constructed in the same manner at all sampling locations to minimize possible discrepancies. The following procedures should be included in any permanent construction protocol:

- a. implants should be installed using an appropriate method based on site conditions (e.g., direct push, manually driven, auger — if necessary to attain the desired depth or if sidewall smearing is a concern, etc.);
- b. porous, inert backfill material (e.g., glass beads, washed #1 crushed stone, etc.) should be used to create a sampling zone 1 to 2 feet in length;
- c. implants should be fitted with inert tubing (e.g., polyethylene, stainless steel, nylon, Teflon[®], etc.) of the appropriate size (typically 1/8 inch to 1/4 inch diameter) and of laboratory or food grade quality to the surface;
- d. soil vapor probes should be sealed above the sampling zone with a bentonite slurry for a minimum distance of 3 feet to prevent outdoor air infiltration and the remainder of the borehole backfilled with clean material;
- e. for multiple probe depths, the borehole should be grouted with bentonite between probes to create discrete sampling zones or separate nested probes should be installed [Figure 2.2]; and
- f. steps should be taken to minimize infiltration of water or outdoor air and to prevent accidental damage (e.g., setting a protective casing around the top of the probe tubing and grouting in place to the top of bentonite, sloping the ground surface to direct water away from the borehole like a groundwater monitoring well, etc.).

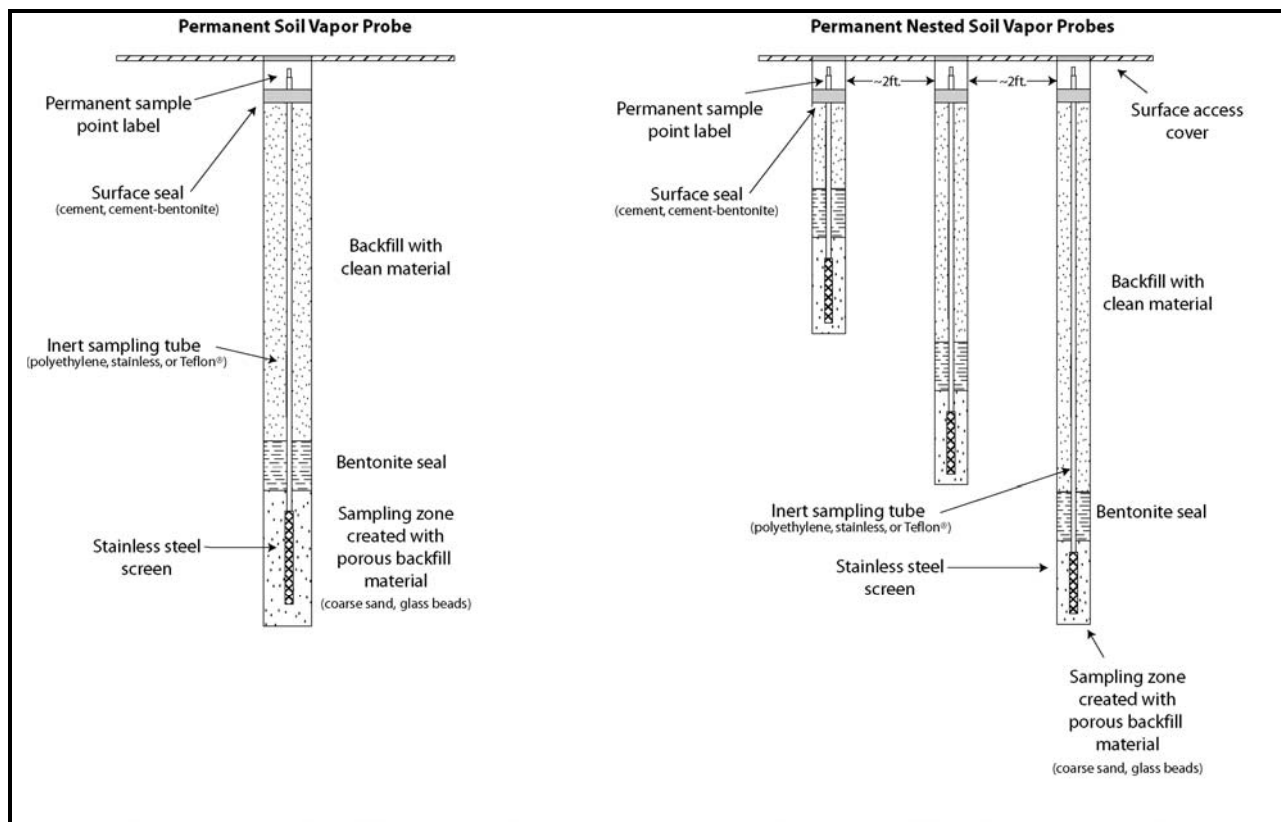

Figure 2.2

Schematics of a generic permanent soil vapor probe and permanent nested soil vapor probes

[Note: Many variations exist and may be proposed in a work plan. Proposed installations should meet the sampling objectives and requirements of the analytical methods.]

To obtain representative samples and to minimize possible discrepancies, soil vapor samples should be collected in the following manner at all locations:

- a. at least 24 hours after the installation of permanent probes and shortly after the installation of temporary probes, one to three implant volumes (i.e., the volume of the sample probe and tube) should be purged prior to collecting the samples;
- b. flow rates for both purging and collecting should not exceed 0.2 liters per minute to minimize outdoor air infiltration during sampling;
- c. samples should be collected, using conventional sampling methods, in an appropriate container — one which
 - i. meets the objectives of the sampling (e.g., investigation of areas where low or high concentrations of volatile chemicals are expected; to minimize losses of volatile chemicals that are susceptible to photodegradation),
 - ii. is consistent with the sampling and analytical methods (e.g., low flow rate; Summa[®] canisters if analyzing by using EPA Method TO-15), and
 - iii. is certified clean by the laboratory;

- d. sample size depends upon the volume of that will achieve minimum reporting limits [Section 2.9]; and
- e. a tracer gas (e.g., helium, butane, sulfur hexafluoride, etc.) should be used when collecting soil vapor samples to verify that adequate sampling techniques are being implemented (i.e., to verify infiltration of outdoor air is not occurring) [Section 2.7.5].

In some cases, weather conditions may present certain limitations on soil vapor sampling. For example, condensation in the sample tubing may be encountered during winter sampling due to low outdoor air temperatures. Devices, such as tube warmers, may be used to address these conditions. Anticipated limitations to the sampling should be discussed prior to the sampling event so appropriate measures can be taken to address these difficulties and produce representative and reliable data.

When soil vapor samples are collected, the following actions should be taken to document local conditions during sampling that may influence interpretation of the results:

- a. if sampling near a commercial or industrial building, uses of volatile chemicals during normal operations of the facility should be identified;
- b. outdoor plot sketches should be drawn that include the site, area streets, neighboring commercial or industrial facilities (with estimated distance to the site), outdoor air sampling locations (if applicable), and compass orientation (north);
- c. weather conditions (e.g., precipitation and outdoor temperature) should be noted for the past 24 to 48 hours; and
- d. any pertinent observations should be recorded, such as odors and readings from field instrumentation.

Additional information that could be gathered to assist in the interpretation of the results includes barometric pressure, wind speed and wind direction.

The field sampling team should maintain a sample log sheet summarizing the following:

- a. sample identification,
- b. date and time of sample collection,
- c. sampling depth,
- d. identity of samplers,
- e. sampling methods and devices,
- f. purge volumes,
- g. volume of soil vapor extracted,
- h. if canisters used, the vacuum before and after samples were collected,
- i. apparent moisture content (dry, moist, saturated, etc.) of the sampling zone, and
- j. chain of custody protocols and records used to track samples from sampling point to analysis.

2.7.2 Sub-slab vapor

During colder months, heating systems should be operating to maintain normal indoor air temperatures (i.e., 65 – 75 °F) for at least 24 hours prior to and during the scheduled sampling time. Prior to installation of the sub-slab vapor probe, the building floor should be inspected and any penetrations (cracks, floor drains, utility perforations, sumps, etc.) should be noted and recorded. Probes should be installed at locations where the potential for ambient air infiltration via floor penetrations is minimal.

Sub-slab vapor probe installations [Figure 2.3] may be permanent, semi-permanent or temporary. A vacuum should not be used to remove drilling debris from the sampling port. Sub-slab implants or probes should be constructed in the same manner at all sampling locations to minimize possible discrepancies. The following procedures should be included in any construction protocol:

- a. permanent recessed probes should be constructed with brass or stainless steel tubing and fittings;
- b. temporary probes should be constructed with inert tubing (e.g., polyethylene, stainless steel, nylon, Teflon[®], etc.) of the appropriate size (typically 1/8 inch to 1/4 inch diameter), and of laboratory or food grade quality;
- c. tubing should not extend further than 2 inches into the sub-slab material;
- d. porous, inert backfill material (e.g., glass beads, washed #1 crushed stone, etc.) should be added to cover about 1 inch of the probe tip for permanent installations; and
- e. the implant should be sealed to the surface with non-VOC-containing and non-shrinking products for temporary installations (e.g., permagum grout, melted beeswax, putty, etc.) or cement for permanent installations.

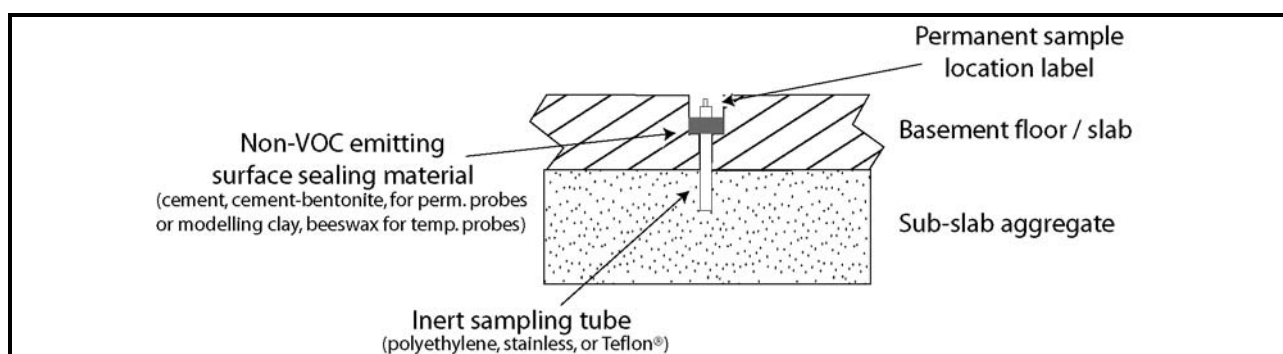

Figure 2.3

Schematic of a generic sub-slab vapor probe

[Note: Many variations exist and may be proposed in a work plan. Proposed installations should meet the sampling objectives and requirements of the analytical methods.]

To obtain representative samples that meet the data quality objectives, sub-slab vapor samples should be collected in the following manner:

- a. after installation of the probes, one to three volumes (i.e., the volume of the sample probe and tube) must be purged prior to collecting the samples to ensure samples collected are representative;
- b. flow rates for both purging and collecting must not exceed 0.2 liters per minute to minimize ambient air infiltration during sampling; and
- c. samples should be collected, using conventional sampling methods, in an appropriate container — one which
 - i. meets the objectives of the sampling (e.g., investigation of areas where low or high concentrations of volatile chemicals are expected; to minimize losses of volatile chemicals that are susceptible to photodegradation),
 - ii. is consistent with the sampling and analytical methods (e.g., low flow rate; Summa[®] canisters if analyzing by using EPA Method TO-15), and
 - iii. is certified clean by the laboratory;
- d. sample size depends upon the volume of that will achieve minimum reporting limits [Section 2.9], the flow rate, and the sampling duration; and
- e. ideally, samples should be collected over the same period of time as concurrent indoor and outdoor air samples.

When sub-slab vapor samples are collected, the following actions should be taken to document conditions during sampling and ultimately to aid in the interpretation of the sampling results [Section 3]:

- a. historic and current storage and uses of volatile chemicals should be identified, especially if sampling within a commercial or industrial building (e.g., use of volatile chemicals in commercial or industrial processes and/or during building maintenance);
- b. the use of heating or air conditioning systems during sampling should be noted;
- c. floor plan sketches should be drawn that include the floor layout with sampling locations, chemical storage areas, garages, doorways, stairways, location of basement sumps or subsurface drains and utility perforations through building foundations, HVAC system air supply and return registers, compass orientation (north), footings that create separate foundation sections, and any other pertinent information should be completed;
- d. outdoor plot sketches should be drawn that include the building site, area streets, outdoor air sampling locations (if applicable), compass orientation (north), and paved areas;
- e. weather conditions (e.g., precipitation and indoor and outdoor temperature) and ventilation conditions (e.g., heating system active and windows closed) should be reported; and
- f. any pertinent observations, such as spills, floor stains, smoke tube results, odors and readings from field instrumentation (e.g., vapors via PID, ppbRAE, Jerome Mercury Vapor Analyzer, etc.), should be recorded.

Additional documentation that could be gathered to assist in the interpretation of the results includes information about air flow patterns and pressure relationships obtained by using smoke tubes or other devices (especially between floor levels and between suspected

contaminant sources and other areas), the barometric pressure and photographs to accompany floor plan sketches.

The field sampling team should maintain a sample log sheet summarizing the following:

- a. sample identification,
- b. date and time of sample collection,
- c. sampling depth,
- d. identity of samplers,
- e. sampling methods and devices,
- f. soil vapor purge volumes,
- g. volume of soil vapor extracted,
- h. if canisters used, vacuum of canisters before and after samples collected,
- i. apparent moisture content (dry, moist, saturated, etc.) of the sampling zone, and
- j. chain of custody protocols and records used to track samples from sampling point to analysis.

2.7.3 Indoor air

[Reference: NYSDOH's *Indoor Air Sampling & Analysis Guidance (February 1, 2005)*]

During colder months, heating systems should be operating to maintain normal indoor air temperatures (i.e., 65 – 75 °F) for at least 24 hours prior to and during the scheduled sampling time. If possible, prior to collecting indoor samples, a pre-sampling inspection [Section 2.11.1] should be performed to evaluate the physical layout and conditions of the building being investigated, to identify conditions that may affect or interfere with the proposed sampling, and to prepare the building for sampling. This process is described in Section 2.11.1.

In general, indoor air samples should be collected in the following manner:

- a. sampling duration should reflect the exposure scenario being evaluated without compromising the detection limit or sample collection flow rate (e.g., an 8 hour sample from a workplace with a single shift versus a 24 hour sample from a workplace with multiple shifts). To ensure that air is representative of the locations sampled and to avoid undue influence from sampling personnel, samples should be collected for at least 1 hour. If the goal of the sampling is to represent average concentrations over longer periods, then longer duration sampling periods may be appropriate. Typically, 24 hour samples are collected from residential settings;
- b. personnel should avoid lingering in the immediate area of the sampling device while samples are being collected;
- c. sample flow rates must conform to the specifications in the sample collection method and, if possible, should be consistent with the flow rates for concurrent outdoor air and sub-slab samples; and
- d. samples must be collected, using conventional sampling methods, in an appropriate container — one which

- i. meets the objectives of the sampling (e.g., investigation of areas where low or high concentrations of volatile chemicals are expected; to minimize losses of volatile chemicals that are susceptible to photodegradation),
- ii. is consistent with the sampling and analytical methods (e.g., low flow rate; Summa[®] canisters if analyzing by using EPA Method TO-15), and
- iii. is certified clean by the laboratory.

At sites with tetrachloroethene contamination, passive air monitors that are specifically analyzed for tetrachloroethene (i.e., "perc badges") are commonly used to collect indoor and outdoor air samples. If site characterization activities indicate that degradation products of tetrachloroethene also represent a vapor intrusion concern, perc badges may be used to indicate the likelihood of vapor intrusion (i.e., by using tetrachloroethene as a surrogate) followed, as appropriate, by more comprehensive sampling and laboratory analyses to quantify both tetrachloroethene and its degradation products. Perc badge samples ideally should be collected over a twenty-four hour period, but for no less than eight hours.

The following actions should be taken to document conditions during indoor air sampling and ultimately to aid in the interpretation of the sampling results [Section 3]:

- a. historic and current uses and storage of volatile chemicals should be identified, especially if sampling within a commercial or industrial building (e.g., use of volatile chemicals in commercial or industrial processes and/or during building maintenance);
- b. a product inventory survey documenting sources of volatile chemicals present in the building during the indoor air sampling that could potentially influence the sample results should be completed [Section 2.11.2];
- c. the use of heating or air conditioning systems during sampling should be noted;
- d. floor plan sketches should be drawn that include the floor layout with sampling locations, chemical storage areas, garages, doorways, stairways, location of basement sumps or subsurface drains and utility perforations through building foundations, HVAC system supply and return registers, compass orientation (north), footings that create separate foundation sections, and any other pertinent information should be completed;
- e. outdoor plot sketches should be drawn that include the building site, area streets, outdoor air sampling locations (if applicable), compass orientation (north), and paved areas;
- f. weather conditions (e.g., precipitation and indoor and outdoor temperature) and ventilation conditions (e.g., heating system active and windows closed) should be reported; and
- g. any pertinent observations, such as spills, floor stains, smoke tube results, odors and readings from field instrumentation (e.g., vapors via PID, ppbRAE, Jerome Mercury Vapor Analyzer, etc.), should be recorded.

Additional documentation that could be gathered to assist in the interpretation of the results includes information about air flow patterns and pressure relationships obtained by using smoke tubes or other devices (especially between floor levels and between suspected contaminant sources and other areas), the barometric pressure and photographs to accompany floor plan sketches.

The field sampling team should maintain a sample log sheet summarizing the following:

- a. sample identification,
- b. date and time of sample collection,
- c. sampling height,
- d. identity of samplers,
- e. sampling methods and devices,
- f. depending upon the method, volume of air sampled,
- g. if canisters are used, vacuum of canisters before and after samples collected, and
- h. chain of custody protocols and records used to track samples from sampling point to analysis.

2.7.4 Outdoor air

Outdoor air samples should be collected simultaneously with indoor air samples to evaluate the potential influence, if any, of outdoor air on indoor air quality. They may also be collected simultaneously with soil vapor samples to identify potential outdoor air interferences associated with infiltration of outdoor air into the sampling apparatus while the soil vapor was collected. To obtain representative samples that meet the data quality objectives, outdoor air samples should be collected in a manner consistent with that for indoor air samples (described in Section 2.7.3).

The following actions should be taken to document conditions during outdoor air sampling and ultimately to aid in the interpretation of the sampling results [Section 3]:

- a. outdoor plot sketches should be drawn that include the building site, area streets, outdoor air sampling locations, the location of potential interferences (e.g., gasoline stations, factories, lawn movers, etc.), compass orientation (north), and paved areas;
- b. weather conditions (e.g., precipitation and outdoor temperature) should be reported; and
- c. any pertinent observations, such as odors, readings from field instrumentation, and significant activities in the vicinity (e.g., operation of heavy equipment or dry cleaners) should be recorded.

2.7.5 Tracer gas

When collecting soil vapor samples as part of a vapor intrusion evaluation, a tracer gas serves as a quality assurance/quality control measure to verify the integrity of the soil vapor probe seal. Without the use of a tracer, there is no way to verify that a soil vapor sample has not been diluted by outdoor air.

Depending on the nature of the contaminants of concern, a number of different compounds can be used as a tracer. Typically, sulfur hexafluoride (SF₆) or helium are used as tracers because they are readily available, have low toxicity, and can be monitored with portable measurement devices. Butane and propane (or other gases) could also be used as a tracer in some situations. Compounds other than those mentioned here may be appropriate, provided they meet project-specific data quality objectives. Where applicable, steps should

be taken to ensure that the gas used by the laboratory to clean the air sampling container is different from the gas used as a tracer during sampling (e.g., helium).

The protocol for using a tracer gas is straightforward: simply enrich the atmosphere in the immediate vicinity of the area where the probe intersects the ground surface with the tracer gas, and measure a vapor sample from the probe for the presence of high concentrations (> 10%) of the tracer. A cardboard box, a plastic pail, or even a garbage bag can serve to keep the tracer gas in contact with the probe during the testing. If there are concerns about infiltration of ambient air through other parts of the sampling train (such as around the fittings, not just at the probe/ground interface), then consideration should be given to ensuring that the tracer gas is in contact with the entire sampling apparatus. In these cases, field personnel may prefer to use a liquid tracer — soaking paper towels with a liquid tracer and placing the towels around the probe/ground interface, around fittings, and/or in the corner of a shroud.

There are two basic approaches to testing for the tracer gas:

1. include the tracer gas in the list of target analytes reported by the laboratory; or
2. use a portable monitoring device to analyze a sample of soil vapor for the tracer prior to and after sampling for the compounds of concern. (Note that the tracer gas samples can be collected via syringe, Tedlar[®] bag etc. They need not be collected in Summa[®] canisters or minicans.)

The advantage of the second approach is that the real time tracer sampling results can be used to confirm the integrity of the probe seals prior to formal sample collection.

Figure 2.4 depicts common methods for using tracer gas. In examples a, b and c, the tracer gas is released in the enclosure prior to initially purging the sample point. Care should be taken to avoid excessive purging prior to sample collection. Care should also be taken to prevent pressure build-up in the enclosure during introduction of the tracer gas. Inspection of the installed sample probe, specifically noting the integrity of the surface seal and the porosity of the soil in which the probe is installed, will help to determine the tracer gas setup. Figure 2.4a may be most effective at preventing tracer gas infiltration, however, it may not be appropriate in some situations depending on site-specific conditions. Figures 2.4b and 2.4c may be sufficient for probes installed in tight soils with well-constructed surface seals. Figure 2d provides an example of using a liquid tracer. In all cases, the same tracer gas application should be used for all probes at any given site.

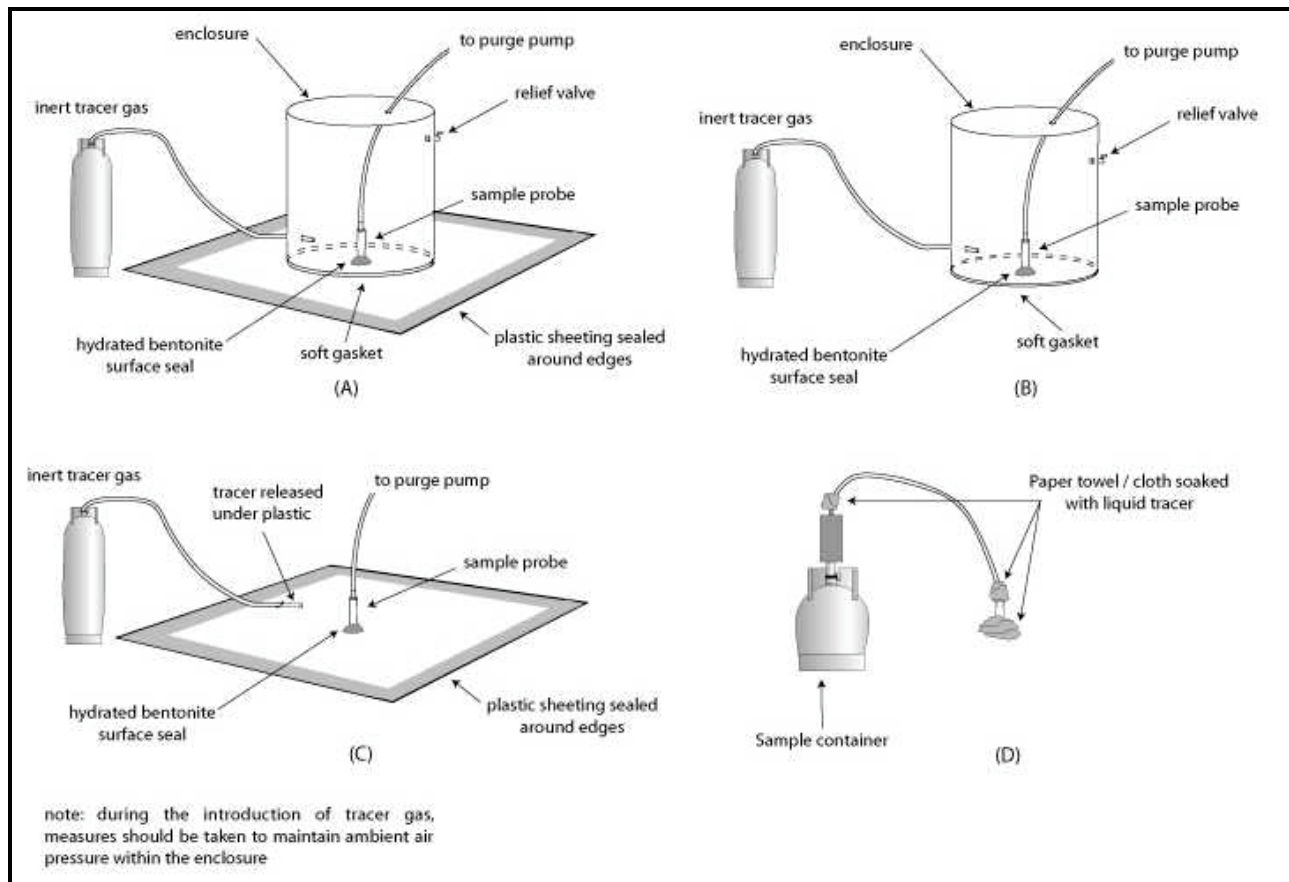

Figure 2.4

Schematics of generic tracer gas applications when collecting soil vapor samples

Because minor leakage around the probe seal should not materially affect the usability of the soil vapor sampling results, the mere presence of the tracer gas in the sample should not be a cause for alarm. Consequently, portable field monitoring devices with detection limits in the low ppm range are more than adequate for screening samples for the tracer. If high concentrations ($> 10\%$) of tracer gas are observed in a sample, the probe seal should be enhanced to reduce the infiltration of outdoor air.

Where permanent or semi-permanent sampling probes are used, tracer gas samples should be collected at each of the sampling probes during the initial stages of a soil vapor sampling program. If the results of the initial samples indicate that the probe seals are adequate, reducing the number of locations at which tracer gas samples are employed may be considered. At a minimum, tracer gas samples should be collected with at least 10% of the soil vapor samples collected in subsequent sampling rounds. When using permanent soil vapor probes as part of a long-term monitoring program, annual testing of the probe integrity is recommended. Where temporary probes are used, tracer gas should be used at every sampling location, every time.

2.8 Quality assurance/quality control (QA/QC)

[Reference: NYSDOH's *Indoor Air Sampling & Analysis Guidance (February 1, 2005)*]

In general, appropriate QA/QC procedures should be followed during all aspects of sample collection and analysis to ensure that sampling error is minimized and high quality data are obtained. Sampling team members should avoid actions (e.g., fueling vehicles, using permanent marking pens, wearing freshly dry-cleaned clothing or personal fragrances, etc.) which can cause sample interference in the field. Portable air monitoring equipment or field instrumentation should be properly maintained, calibrated and tested to ensure validity of measurements. Air sampling equipment should be stored, transported and between samples decontaminated in a manner consistent with the best environmental consulting practices to minimize problems such as field contamination and cross-contamination. Samples should be collected using certified clean sample devices. Where applicable, steps should be taken to ensure that the gas used by the laboratory to clean the sample device is different from the gas used as a tracer during sampling (e.g., helium). Samples should meet sample holding times and temperatures, and should be delivered to the analytical laboratory as soon as possible after collection. In addition, laboratory accession procedures should be followed, including field documentation (sample collection information and locations), chain of custody, field blanks, field sample duplicates and laboratory duplicates, as appropriate.

Some methods call for collecting samples in duplicate (e.g., indoor air sampling using passive sampling devices for tetrachloroethene) to assess errors. Duplicate and/or split samples should be collected in accordance with the sampling and analytical methods being implemented.

For certain regulatory programs, a Data Usability Summary Report (DUSR) or equivalent report may be required to determine whether or not the data, as presented, meets the site or project specific criteria for data quality and data use. This requirement may dictate the level of QC and the category of data deliverable to request from the laboratory. Guidance on preparing these reports is available by contacting the NYSDEC's Division of Environmental Remediation.

New York State Public Health Law requires laboratories analyzing environmental samples collected from within New York State to have current Environmental Laboratory Approval Program (ELAP) certification for the appropriate analyte and environmental matrix combinations. If ELAP certification is not currently required for an analyte (e.g., trichloroethene), the analysis should be performed by a laboratory that has ELAP certification for similar compounds in air and uses analytical methods with minimum reporting limits similar to background (e.g., tetrachloroethene via EPA Method TO-15). Questions about a laboratory's current certification status should be directed to an ELAP representative at 518-485-5570 or by email at elap@health.state.ny.us.

The work plan should state that all samples that will be used to make decisions on appropriate actions to address exposures and environmental contamination will be analyzed by an ELAP-certified laboratory. The name of the laboratory should also be provided. Similarly, the name of the laboratory that was used should be included in the report of the sampling results. For samples collected and tested in the field for screening purposes by using field testing technology, the qualifications of the field technician should be documented in the work plan.

2.9 Analytical methods

[Reference: NYSDOH's *Indoor Air Sampling & Analysis Guidance (February 1, 2005)*]

Proposed analytical procedures should be identified in work plans. Similarly, the analytical procedures that were used and corresponding reporting limits should be identified when reporting the sampling results. When selecting an appropriate analytical method, the data quality objectives should be considered. As described in Section 3, comparing sampling results for volatile chemicals with background concentrations and with indoor air/sub-slab vapor matrices are critical components of the data evaluation process. Therefore, samples should be analyzed by methods that can achieve minimum reporting limits to allow for comparison of the results with background levels and with the levels presented in the matrices [Section 3.4.2]. If there are additional data quality objectives, they should be considered also. Typically, a minimum reporting limit of 1 microgram per cubic meter (1 mcg/m³) or less is sufficient for most analytes. Examples of commonly used analytical methods include the following:

- a. EPA Method TO-15 for a wide range of VOCs (e.g., samples from evacuated canisters),
- b. NYSDOH Method 311-9 for tetrachloroethene (i.e., samples from perc badges),
- c. EPA Method TO-17 for VOCs (e.g., samples collected with sorbent tubes), and
- d. EPA Method TO-15 for VOCs with selective ion monitoring (SIM) (e.g., to achieve minimum reporting limits lower than those achieved with Method TO-15 alone).

The laboratory should verify that they are capable of detecting the appropriate analytes and can report them at the appropriate reporting limit.

2.9.1 Subsurface vapor

Soil vapor and sub-slab vapor samples should be analyzed for a wide range of volatile chemicals during the first round of sampling (at a minimum) — unless it can be demonstrated that an abbreviated or site-specific analyte list is appropriate. This is analogous to analyzing groundwater samples for a suite of compounds (e.g., EPA's target analyte list/target compound list (TAL/TCL) chemicals) during the initial rounds of site characterization. Based on the initial sampling results, development and application of a site-specific analyte list may be considered for analysis of subsequent soil vapor and sub-slab vapor samples.

If a site-specific analyte list is developed, it should include the following:

- a. volatile chemicals which have been previously detected in environmental media (e.g., soil, groundwater and air) at the site;
- b. volatile chemicals which are known or demonstrated constituents of the contamination in question (e.g., petroleum products or tars from former manufactured gas plants); and
- c. expected degradation products of the chemicals mentioned in a or b.

A site-specific analyte list might also include indicator compounds to assist in identifying and differentiating subsurface sources of volatile chemical contamination. The following are examples of indicator compounds that have been included in site-specific analyte lists given the nature of the contamination or type of site:

- a. gasoline: benzene, toluene, ethylbenzene, xylenes, trimethylbenzene isomers, individual C-4 to C-8 aliphatics (e.g., hexane, cyclohexane, dimethylpentane, 2,2,4-trimethylpentane, etc.), and appropriate oxygenate additives (e.g., methyl-*tert*-butyl ether, ethanol, etc.);
- b. middle distillate fuels (#2 fuel oil, diesel and kerosene): n-nonane, n-decane, n-undecane, n-dodecane, ethylbenzene, xylenes, trimethylbenzene isomers, tetramethylbenzene isomers, naphthalene, 1-methylnaphthalene, and 2-methylnaphthalene;
- c. manufactured gas plant sites: trimethylbenzene isomers, tetramethylbenzene isomers, thiopenes, indene, indane, and naphthalene;
- d. natural gas: propane, propene, butane, iso-butane, methylbutane, and n-pentane with lower levels of higher molecular weight aliphatic, olefinic, and some aromatic compounds; and
- e. solvent-using industries: the solvent and its expected degradation products (e.g., tetrachloroethene, trichloroethene, dichloroethene(s), and vinyl chloride).

2.9.2 Indoor air

Indoor and outdoor air samples should be analyzed for a wide range of volatile chemicals if there are no existing data for subsurface vapors — unless it can be demonstrated that an abbreviated or site-specific analyte list is appropriate. If indoor air sampling is appropriate based on the levels of volatile chemicals in subsurface vapors, analysis of indoor air samples specifically for those volatile chemicals may be considered.

2.9.3 Outdoor air

Outdoor air samples should be analyzed in a manner consistent with corresponding indoor air samples.

2.10 **Field laboratories and mobile gas chromatographs (GCs)**

Use of field laboratories and mobile GCs as screening tools when collecting soil vapor samples may be considered on a site-specific basis. However, without ELAP certification, screening tools such as these are not acceptable when collecting sub-slab vapor, indoor air and outdoor air samples for the purpose of evaluating exposures related to soil vapor intrusion. ELAP certification for a particular laboratory does not indicate mobile laboratory or GC certification. Mobile laboratories and GCs have specific certification requirements through ELAP. Questions regarding a mobile laboratory's certification should be directed to the laboratory itself.

2.11 **Surveys and pre-sampling building preparation**

[Reference: NYSDOH's *Indoor Air Sampling & Analysis Guidance (February 1, 2005)*]

2.11.1 Pre-sampling building inspection and preparation

A pre-sampling inspection should be performed prior to each sampling event to identify and minimize conditions that may interfere with the proposed testing. The inspection should evaluate the type of structure, floor layout, air flows and physical conditions of the building(s) being studied. This information, along with information on sources of potential

indoor air contamination [Section 2.11.2], should be identified on a building inventory form. An example of a building inventory form is given in Appendix B. Items to be included in the building inventory include the following:

- a. construction characteristics, including foundation cracks and utility penetrations or other openings that may serve as preferential pathways for vapor intrusion;
- b. presence of an attached garage;
- c. recent renovations or maintenance to the building (e.g., fresh paint, new carpet or furniture);
- d. mechanical equipment that can affect pressure gradients (e.g., heating systems, clothes dryers or exhaust fans);
- e. use or storage of petroleum products (e.g., fuel containers, gasoline operated equipment and unvented kerosene heaters); and
- f. recent use of petroleum-based finishes or products containing volatile chemicals.

Each room on the floor of the building being tested and on lower floors, if possible, should be inspected. This is important because even products stored in another area of a building can affect the air of the room being tested.

The presence and description of odors (e.g., solvent, moldy) and portable vapor monitoring equipment readings (e.g., PIDs, ppbRAE, Jerome Mercury Vapor Analyzer, etc.) should be noted and used to help evaluate potential sources. This includes taking readings near products stored or used in the building. Where applicable, readings should be provided in units that denote the calibration gas (e.g., isobutylene-equivalent ppm, benzene-equivalent ppm, etc.).

Potential interference from products or activities releasing volatile chemicals should be controlled to the extent practicable. Removing the source from the indoor environment prior to testing is the most effective means of reducing interference. Ensuring that containers are tightly sealed may be sufficient. When testing for volatile organic compounds, containers should be tested with portable vapor monitoring equipment to determine whether compounds are leaking. The inability to eliminate potential interference may be justification for not testing, especially when testing for similar compounds at low levels. The investigator should consider the possibility that chemicals may adsorb onto porous materials and may take time to dissipate.

In some cases, the goal of the testing is to evaluate the impact from products used or stored in the building (e.g., pesticide misapplications, school renovation projects). If the goal of the testing is to determine whether products are an indoor volatile chemical contaminant source, the removing these sources does not apply.

Once interfering conditions are corrected (if applicable), ventilation may be appropriate prior to sampling to minimize residual contamination in the indoor air. If ventilation is appropriate, it should be completed 24 hours or more prior to the scheduled sampling time. Where applicable, ventilation can be accomplished by operating the building's HVAC system to maximize outside air intake. Opening windows and doors, and operating exhaust fans may also help or may be appropriate if the building has no HVAC system.

Air samples are sometimes designed to represent typical exposure in a mechanically ventilated building and the operation of HVAC systems during sampling should be noted on

the building inventory form [Appendix B]. When samples are collected, the building's HVAC system should be operating in a manner consistent with normal operating conditions when the building is occupied (e.g., schools, businesses, etc.). Unnecessary building ventilation should be avoided within 24 hours prior to and during sampling. During colder months, heating systems should be operating to maintain normal indoor air temperatures (i.e., 65 – 75 °F) for at least 24 hours prior to and during the scheduled sampling time.

Depending upon the goal of the indoor air sampling, some situations may warrant deviation from the above protocol regarding building ventilation. In such cases, building conditions and sampling efforts should be understood and noted within the framework and scope of the investigation.

To avoid potential interferences and dilution effects, occupants should make a reasonable effort to avoid the following for 24 hours prior to sampling:

- a. opening any windows, fireplace dampers, openings or vents;
- b. operating ventilation fans unless special arrangements are made;
- c. smoking in the building;
- d. painting;
- e. using a wood stove, fireplace or other auxiliary heating equipment (e.g., kerosene heater);
- f. operating or storing automobile in an attached garage;
- g. allowing containers of gasoline or oil to remain within the house or garage area, except for fuel oil tanks;
- h. cleaning, waxing or polishing furniture, floors or other woodwork with petroleum- or oil-based products;
- i. using air fresheners, scented candles or odor eliminators;
- j. engaging in any hobbies that use materials containing volatile chemicals;
- k. using cosmetics including hairspray, nail polish, nail polish removers, perfume/cologne, etc.;
- l. lawn mowing, paving with asphalt, or snow blowing;
- m. applying pesticides;
- n. using building repair or maintenance products, such as caulk or roofing tar; and
- o. bringing freshly dry-cleaned clothing or furnishings into the building.

2.11.2 Product inventory

The primary objective of the product inventory is to identify potential air sampling interference by characterizing the occurrence and use of chemicals and products throughout the building, keeping in mind the goal of the investigation and site-specific contaminants of concern. For example, it is not appropriate to provide detailed information for each individual container of like items. However, it is appropriate to indicate that "20 bottles of perfume" or "12 cans of latex paint" were present with containers in good condition. This information is used to help formulate an indoor environment profile.

An inventory should be provided for each room on the floor of the building being tested and on lower floors, if possible. This is important because even products stored in another area of a building can affect the air of the room being tested.

The presence and description of odors (e.g., solvent, moldy) and portable vapor monitoring equipment readings (e.g., PIDs, ppbRAE, Jerome Mercury Vapor Analyzer, etc.) should be noted and used to help evaluate potential sources. This includes taking readings near products stored or used in the building. Where applicable, readings should be provided in units that denote the calibration gas (e.g., isobutylene-equivalent ppm, benzene-equivalent ppm, etc.).

Products in buildings should be inventoried every time air is tested to provide an accurate assessment of the potential contribution of volatile chemicals. If available, chemical ingredients of interest (e.g., analyte list) should be recorded for each product. If the ingredients are not listed on the label, record the product's exact and full name, and the manufacturer's name, address and telephone number, if available. In some cases, material Safety Data Sheets may be useful for identifying confounding sources of volatile chemicals in air. Adequately documented photographs of the products and their labeled ingredients can supplement the inventory and facilitate recording the information.

2.12 Role of modeling

At sites where there is a potential for human exposures to subsurface contamination due to soil vapor intrusion (as described in Section 2.1), use of modeling as the sole means of evaluating potential exposures should be avoided. The limitations of modeling (e.g., exclusion of preferential migration pathways) introduce uncertainty as to whether human exposure is occurring, in absence of actual field data. Conclusions drawn from modeling should be verified with actual field data. For example, if modeling results indicate indoor air concentrations are predicted to be below applicable guidelines or levels of concern, indoor air and/or sub-slab vapor sampling would be appropriate to verify a conclusion that mitigation or other actions are not needed.

Modeling may, however, be used as a tool in the evaluation process. Examples of situations in which modeling may be used as a tool include, but are not limited to, the following:

- a. to help identify potential migration pathways on the basis of site-specific conditions;
- b. to estimate potential exposures when field samples cannot be collected (e.g., access to collect the samples is denied or buildings have not yet been constructed over the subsurface contamination); and
- c. to identify a preferred order for sampling buildings by predicting expected indoor air concentrations within each of the buildings if there are numerous buildings overlying the subsurface contamination.

Use of any model at a site should be discussed with the agencies prior to the model's development and application. If a model is used, it should incorporate site-specific parameters (e.g., attenuation factors, soil conditions, concentrations of volatile chemicals, depth to subsurface source, characteristics of subsurface source, and foundation slab thickness) as much as possible. Furthermore, both the limitations of the model (e.g., exclusion of preferential migration pathways) and the sensitivity of the variables in the model should be understood and identified with the modeling results.

Soil Vapor/Indoor Air Matrix 1

October 2006

SUB-SLAB VAPOR CONCENTRATION of COMPOUND (mcg/m ³)	INDOOR AIR CONCENTRATION of COMPOUND (mcg/m ³)			
	< 0.25	0.25 to < 1	1 to < 5.0	5.0 and above
< 5	1. No further action	2. Take reasonable and practical actions to identify source(s) and reduce exposures	3. Take reasonable and practical actions to identify source(s) and reduce exposures	4. Take reasonable and practical actions to identify source(s) and reduce exposures
5 to < 50	5. No further action	6. MONITOR	7. MONITOR	8. MITIGATE
50 to < 250	9. MONITOR	10. MONITOR / MITIGATE	11. MITIGATE	12. MITIGATE
250 and above	13. MITIGATE	14. MITIGATE	15. MITIGATE	16. MITIGATE

No further action:

Given that the compound was not detected in the indoor air sample and that the concentration detected in the sub-slab vapor sample is not expected to significantly affect indoor air quality, no additional actions are needed to address human exposures.

Take reasonable and practical actions to identify source(s) and reduce exposures:

The concentration detected in the indoor air sample is likely due to indoor and/or outdoor sources rather than soil vapor intrusion given the concentration detected in the sub-slab vapor sample. Therefore, steps should be taken to identify potential source(s) and to reduce exposures accordingly (e.g., by keeping containers tightly capped or by storing volatile organic compound-containing products in places where people do not spend much time, such as a garage or outdoor shed). Resampling may be recommended to demonstrate the effectiveness of actions taken to reduce exposures.

MONITOR:

Monitoring, including sub-slab vapor, basement air, lowest occupied living space air, and outdoor air sampling, is needed to determine whether concentrations in the indoor air or sub-slab vapor have changed. Monitoring may also be needed to determine whether existing building conditions (e.g., positive pressure heating, ventilation and air-conditioning systems) are maintaining the desired mitigation endpoint and to determine whether changes are needed. The type and frequency of monitoring is determined on a site-specific and building-specific basis, taking into account applicable environmental data and building operating conditions. Monitoring is an interim measure required to evaluate exposures related to soil vapor intrusion until contaminated environmental media are remediated.

MITIGATE:

Mitigation is needed to minimize current or potential exposures associated with soil vapor intrusion. The most common mitigation methods are sealing preferential pathways in conjunction with installing a sub-slab depressurization system, and changing the pressurization of the building in conjunction with monitoring. The type, or combination of types, of mitigation is determined on a building-specific basis, taking into account building construction and operating conditions. Mitigation is considered a temporary measure implemented to address exposures related to soil vapor intrusion until contaminated environmental media are remediated.

MONITOR / MITIGATE:

Monitoring or mitigation may be recommended after considering the magnitude of sub-slab vapor and indoor air concentrations along with building- and site-specific conditions.

See additional notes on page 2.

ADDITIONAL NOTES FOR MATRIX 1

This matrix summarizes the minimum actions recommended to address current and potential exposures related to soil vapor intrusion. To use the matrix appropriately as a tool in the decision-making process, the following should be noted:

- [1] The matrix is generic. As such, it may be appropriate to modify a recommended action to accommodate building-specific conditions (e.g., dirt floor in basement, crawl spaces, etc.) and/or factors provided in Section 3.2 of the guidance (e.g., current land use, environmental conditions, etc.). For example, resampling may be recommended when the matrix indicates "no further action" for a particular building, but the results of adjacent buildings (especially sub-slab vapor results) indicate a need to take actions to address exposures related to soil vapor intrusion. Additionally, actions more protective of public health than those specified within the matrix may be proposed at any time. For example, the party implementing the actions may decide to install sub-slab depressurization systems on buildings where the matrix indicates "no further action" or "monitoring." Such an action is usually undertaken for reasons other than public health (e.g., seeking community acceptance, reducing excessive costs, etc.).
- [2] Actions provided in the matrix are specific to addressing human exposures. Implementation of these actions does not preclude investigating possible sources of vapor contamination, nor does it preclude remediating contaminated soil vapors or the source of soil vapor contamination.
- [3] Appropriate care should be taken during all aspects of sample collection to ensure that high quality data are obtained. Since the data are being used in the decision-making process, the laboratory analyzing the environmental samples must have current Environmental Laboratory Approval Program (ELAP) certification for the appropriate analyte and environmental matrix combinations. Furthermore, samples should be analyzed by methods that can achieve a minimum reporting limit of 0.25 microgram per cubic meter for indoor and outdoor air samples. For sub-slab vapor samples, a minimum reporting limit of 5 micrograms per cubic meter is recommended for buildings with full slab foundations, and 1 microgram per cubic meter for buildings with less than a full slab foundation.
- [4] Sub-slab vapor and indoor air samples are typically collected when the likelihood of soil vapor intrusion to occur is considered to be the greatest (i.e., worst-case conditions). If samples are collected at other times (typically, samples collected outside of the heating season), then resampling during worst-case conditions may be appropriate to verify that actions taken to address exposures related to soil vapor intrusion are protective of human health.
- [5] When current exposures are attributed to sources other than soil vapor intrusion, the agencies should be given documentation (e.g., applicable environmental data, completed indoor air sampling questionnaire, digital photographs, etc.) to support a proposed action other than that provided in the matrix box and to support agency assessment and follow-up.
- [6] The party responsible for implementing the recommended actions will differ depending upon several factors, including the identified source of the volatile chemicals, the environmental remediation program, and site-specific and building-specific conditions. For example, to the extent that all site data and site conditions demonstrate that soil vapor intrusion is not occurring and that the potential for soil vapor intrusion to occur is not likely, the soil vapor intrusion investigation would be considered complete. In general, if indoor exposures represent a concern due to indoor sources, then the State will provide guidance to the property owner and/or tenant on ways to reduce their exposure. If indoor exposures represent a concern due to outdoor sources, then the NYSDEC will decide who is responsible for further investigation and any necessary remediation. Depending upon the outdoor source, this responsibility may or may not fall upon the party conducting the soil vapor intrusion investigation.

Soil Vapor/Indoor Air Matrix 2

October 2006

SUB-SLAB VAPOR CONCENTRATION of COMPOUND (mcg/m ³)	INDOOR AIR CONCENTRATION of COMPOUND (mcg/m ³)			
	< 3	3 to < 30	30 to < 100	100 and above
< 100	1. No further action	2. Take reasonable and practical actions to identify source(s) and reduce exposures	3. Take reasonable and practical actions to identify source(s) and reduce exposures	4. Take reasonable and practical actions to identify source(s) and reduce exposures
100 to < 1,000	5. MONITOR	6. MONITOR / MITIGATE	7. MITIGATE	8. MITIGATE
1,000 and above	9. MITIGATE	10. MITIGATE	11. MITIGATE	12. MITIGATE

No further action:

Given that the compound was not detected in the indoor air sample and that the concentration detected in the sub-slab vapor sample is not expected to significantly affect indoor air quality, no additional actions are needed to address human exposures.

Take reasonable and practical actions to identify source(s) and reduce exposures:

The concentration detected in the indoor air sample is likely due to indoor and/or outdoor sources rather than soil vapor intrusion given the concentration detected in the sub-slab vapor sample. Therefore, steps should be taken to identify potential source(s) and to reduce exposures accordingly (e.g., by keeping containers tightly capped or by storing volatile organic compound-containing products in places where people do not spend much time, such as a garage or outdoor shed). Resampling may be recommended to demonstrate the effectiveness of actions taken to reduce exposures.

MONITOR:

Monitoring, including sub-slab vapor, basement air, lowest occupied living space air, and outdoor air sampling, is needed to determine whether concentrations in the indoor air or sub-slab vapor have changed. Monitoring may also be needed to determine whether existing building conditions (e.g., positive pressure heating, ventilation and air-conditioning systems) are maintaining the desired mitigation endpoint and to determine whether changes are needed. The type and frequency of monitoring is determined on a site-specific and building-specific basis, taking into account applicable environmental data and building operating conditions. Monitoring is an interim measure required to evaluate exposures related to soil vapor intrusion until contaminated environmental media are remediated.

MITIGATE:

Mitigation is needed to minimize current or potential exposures associated with soil vapor intrusion. The most common mitigation methods are sealing preferential pathways in conjunction with installing a sub-slab depressurization system, and changing the pressurization of the building in conjunction with monitoring. The type, or combination of types, of mitigation is determined on a building-specific basis, taking into account building construction and operating conditions. Mitigation is considered a temporary measure implemented to address exposures related to soil vapor intrusion until contaminated environmental media are remediated.

MONITOR / MITIGATE:

Monitoring or mitigation may be recommended after considering the magnitude of sub-slab vapor and indoor air concentrations along with building- and site-specific conditions.

See additional notes on page 2.

ADDITIONAL NOTES FOR MATRIX 2

This matrix summarizes the minimum actions recommended to address current and potential exposures related to soil vapor intrusion. To use the matrix appropriately as a tool in the decision-making process, the following should be noted:

- [1] The matrix is generic. As such, it may be appropriate to modify a recommended action to accommodate building-specific conditions (e.g., dirt floor in basement, crawl spaces, etc.) and/or factors provided in Section 3.2 of the guidance (e.g., current land use, environmental conditions, etc.). For example, resampling may be recommended when the matrix indicates "no further action" for a particular building, but the results of adjacent buildings (especially sub-slab vapor results) indicate a need to take actions to address exposures related to soil vapor intrusion. Additionally, actions more protective of public health than those specified within the matrix may be proposed at any time. For example, the party implementing the actions may decide to install sub-slab depressurization systems on buildings where the matrix indicates "no further action" or "monitoring." Such an action is usually undertaken for reasons other than public health (e.g., seeking community acceptance, reducing excessive costs, etc.).
- [2] Actions provided in the matrix are specific to addressing human exposures. Implementation of these actions does not preclude investigating possible sources of vapor contamination, nor does it preclude remediating contaminated soil vapors or the source of soil vapor contamination.
- [3] Appropriate care should be taken during all aspects of sample collection to ensure that high quality data are obtained. Since the data are being used in the decision-making process, the laboratory analyzing the environmental samples must have current Environmental Laboratory Approval Program (ELAP) certification for the appropriate analyte and environmental matrix combinations. Furthermore, samples should be analyzed by methods that can achieve a minimum reporting limit of 3 micrograms per cubic meter for indoor and outdoor air samples. For sub-slab vapor samples, a minimum reporting limit of 5 micrograms per cubic meter is recommended.
- [4] Sub-slab vapor and indoor air samples are typically collected when the likelihood of soil vapor intrusion to occur is considered to be the greatest (i.e., worst-case conditions). If samples are collected at other times (typically, samples collected outside of the heating season), then resampling during worst-case conditions may be appropriate to verify that actions taken to address exposures related to soil vapor intrusion are protective of human health.
- [5] When current exposures are attributed to sources other than soil vapor intrusion, the agencies should be given documentation (e.g., applicable environmental data, completed indoor air sampling questionnaire, digital photographs, etc.) to support a proposed action other than that provided in the matrix box and to support agency assessment and follow-up.
- [6] The party responsible for implementing the recommended actions will differ depending upon several factors, including the identified source of the volatile chemicals, the environmental remediation program, and site-specific and building-specific conditions. For example, to the extent that all site data and site conditions demonstrate that soil vapor intrusion is not occurring and that the potential for soil vapor intrusion to occur is not likely, the soil vapor intrusion investigation would be considered complete. In general, if indoor exposures represent a concern due to indoor sources, then the State will provide guidance to the property owner and/or tenant on ways to reduce their exposure. If indoor exposures represent a concern due to outdoor sources, then the NYSDEC will decide who is responsible for further investigation and any necessary remediation. Depending upon the outdoor source, this responsibility may or may not fall upon the party conducting the soil vapor intrusion investigation.

Section 4: Soil Vapor Intrusion Mitigation

As discussed in Section 1.1, soil vapor can enter a building through cracks or perforations in slabs or basement floors and walls, and through openings around sump pumps or where pipes and electrical wires go through the foundation primarily because of a difference between interior and exterior pressures. This intrusion is similar to how radon gas enters buildings from the subsurface. Fortunately, given this similarity, well-established techniques for mitigating exposures to radon may also be used to mitigate exposures related to soil vapor intrusion.

Once it is determined that steps should be taken to address exposures associated with soil vapor intrusion, they should be implemented with all due expediency. This section provides an overview of:

- a. methods of mitigation,
- b. installation and design of mitigation systems,
- c. post-mitigation testing,
- d. operation, maintenance and monitoring of mitigation systems,
- e. termination of mitigation system operations, and
- f. annual certification.

Mitigation is considered to be an interim measure to address exposures until contaminated environmental media are remediated, or until mitigation is no longer needed to address exposures related to soil vapor intrusion.

4.1 Methods of mitigation

The most effective mitigation methods involve sealing infiltration points and actively manipulating the pressure differential between the building's interior and exterior (on a continuous basis). As discussed in the following subsections, the appropriate method to use will largely depend upon the building's foundation design. Furthermore, buildings having more than one foundation design feature (e.g., a basement under one portion of the house and a crawl space beneath the remainder) may require a combination of mitigation methods. This section describes methods of mitigation that are expected to be the most reliable options under a wide range of circumstances. Occasionally, there are site-specific or building-specific conditions under which alternative methods (such as HVAC modification, sealing, room pressurization, passive ventilation systems, or vapor barriers) may be more appropriate. Such mitigation proposals may be considered on a case-by-case basis.

4.1.1 Buildings with a basement slab or slab-on-grade foundation

In conjunction with *sealing* potential subsurface vapor entry points, an active *sub-slab depressurization system* (SSD system) is the preferred mitigation method for buildings with a basement slab or slab-on-grade foundation. A SSD system uses a fan-powered vent and piping to draw vapors from the soil beneath the building's slab (i.e., essentially creating a vacuum beneath the slab) and discharge them to the atmosphere. This results in lower sub-slab air pressure relative to indoor air pressure, which prevents the infiltration of sub-slab vapors into the building.

The most common approach to achieving depressurization beneath the slab is to insert the piping through the floor slab into the crushed rock or soil underneath. However, the EPA, in their "Consumer's Guide to Radon Reduction" (EPA 402-K-03-002; revised February 2003), lists the following approaches as ways to reduce radon levels in a building, either in place of the more common sub-slab suction point method or in conjunction with that method:

- a. *Drain tile suction* — Some houses have drain tiles or perforated pipe to direct water away from the foundation of the house. Suction on these tiles or pipes is often effective;
- b. *Sump hole suction* — If the building has a sump pump to remove unwanted water, the sump can be capped so that it can continue to drain water and serve as the location for piping. If the sump is not used as the suction or extraction point, the associated wiring and piping should be sealed and an air-tight cover should be installed to enhance the performance of the SSD system; and
- c. *Block wall suction* — If the building has hollow block foundation walls, the void network within the wall may be depressurized by drawing air from inside the wall and venting it to the outside. This method is often used in combination with sub-slab depressurization.

The depressurization approach, or combination of approaches, selected for a building should be determined on a building-specific basis due to building-specific features that may be conducive to a specific depressurization approach. For example, if the contaminants are entering the building through a block wall, block wall suction in conjunction with traditional sub-slab depressurization may be more effective at minimizing exposures related to soil vapor intrusion rather than sub-slab depressurization alone.

Although sealing is not a reliable mitigation technique on its own, it can significantly improve the effectiveness of a SSD system since it limits the flow of subsurface vapors into the building. All joints, cracks and other penetrations of slabs, floor assemblies and foundation walls below or in contact with the ground surface should be sealed with materials that prevent air leakage.

If the State concurs that a SSD system is not a practicable alternative or that exposures will be mitigated concurrently by a method selected to remediate subsurface contamination, alternative mitigation methods may be considered, such as the following:

- a. *HVAC modification* — a technique where the building's HVAC system is modified to avoid depressurization of the building relative to underlying and surrounding soil (i.e., to maintain a positive pressure within the building); and
- b. *Soil vapor extraction (SVE) system* — a technique used to remediate contaminated subsurface soil vapor. SVE systems use high flow rates, induced vacuum or both to collect and remove contamination, while SSD systems use a minimal flow rate to effect the minimum pressure gradient (see the EPA's technical guidance documents for recommended gradients; Section 4.2.3) needed to reverse air flow across a building's foundation. Depending upon the SVE system's design, the system may also serve to mitigate exposures. For example, the SVE system's radius of influence includes the subsurface beneath affected buildings or horizontal legs of the system will be installed beneath affected buildings. However, complications can arise if the SVE system is no longer effective at remediating contaminated vapors, exposures should still be mitigated due to residual vapor contamination.

4.1.2 Buildings with a crawl space foundation

A *soil vapor retarder with sub-membrane depressurization (SMD) system* is the preferred mitigation method for buildings with a crawl space foundation. A soil vapor retarder is a synthetic membrane or other comparable material that is placed on the ground in the crawl space to retard the flow of soil vapors into the building. A SMD system is similar to a SSD system. It uses a fan-powered vent and piping to draw vapors from beneath the soil vapor retarder and discharge them to the atmosphere. This results in lower air pressure beneath the membrane relative to air pressure in the crawl space, which prevents the infiltration of subsurface vapors into the building.

If the State concurs that a soil vapor retarder with a SMD system is not a practicable alternative or that exposures will be mitigated concurrently by a method selected to remediate subsurface contamination, alternative mitigation methods may be considered, such as the following:

- a. *HVAC modification* — a technique where the building's HVAC system is modified to avoid depressurization of the building relative to the crawl space;
- b. *Crawl space ventilation with sealing* — a technique that uses a fan to draw air out of the crawl space; and
- c. *SVE system* [Section 4.1.1].

4.1.3 Buildings with dirt floor basements

Either a SSD system with a newly poured slab or a SMD system with a soil vapor retarder may be used. However, the former method is preferred.

4.1.4 Buildings with multiple foundation types

Mitigation in a building with a combination of foundations should be achieved by applying the specific methods described previously [Sections 4.1.1 through 4.1.3] to the corresponding foundation segments of the building. Special consideration should be given to the points at which different foundation types join, since additional soil vapor entry routes exist in such locations. Often, the various systems can be installed and connected to a common depressurization system and fan.

4.1.5 Undeveloped parcels

If sampling results indicate a mitigation system is recommended to address exposures in buildings that may be constructed, then a SSD system with sealing, or a SMD system with a soil vapor retarder, or a combination of these methods is recommended, as appropriate to the design of the proposed buildings.

4.1.6 Additional references

The following documents provide additional information on selecting an appropriate mitigation method:

- a. *A Consumer's Guide to Radon Reduction*
EPA [EPA 402-K-03-002, revised February 2003]

This document provides assistance in selecting a qualified radon mitigation contractor to reduce the radon levels in a home, determining an appropriate radon reduction method, and maintaining a radon reduction system. It is available at the EPA's web site: <http://www.epa.gov/iaq/radon/pubs/index.html>; and

- b. *Reducing Radon in Schools: A Team Approach*
EPA [EPA 402-R-94-008, April 1994]

This document will provide assistance in determining the best way to reduce elevated radon levels found in a school. It provides guidance on the process of confirming a radon problem, selecting the best mitigation strategy, and directing the efforts of a multidisciplinary team assembled to address elevated radon levels in a way that will contribute to the improvement of the overall indoor air quality of the school. Copies can be ordered from the EPA's Indoor Air Quality Information Clearinghouse at 1-800-438-4318.

4.2 Design and installation of mitigation systems

Once a mitigation method is selected, it should be designed and installed. The components of the design and installation of mitigation systems, the procedures for specific mitigation techniques, and references for technical guidance are provided in the following subsections.

4.2.1 General recommendations

Systems should be designed and installed by a professional engineer or environmental professional. In most areas of the state, there are contractors who have met certain requirements and are trained to identify and fix radon problems in buildings. To obtain the names of local contractors, contact the NYSDOH's Radon Program at 1-800-458-1158, extension 27556, or visit the National Radon Safety Board's web site (www.nrsb.org) or National Environmental Health Association's web site (www.neha.org).

Typically, the party responsible for remediating the site is responsible for arranging design and installation activities. If no responsible party is available, the State will arrange for the design and installation of the system. All design and installation activities should be documented and reported to the agencies. Furthermore, once a mitigation system is installed, an information package should be given to the building's owner and tenants, if applicable, to facilitate their understanding of the system's operation, maintenance and monitoring [Section 5.6].

With the exception of SVE systems, the mitigation methods introduced in Section 4.1 are not intended to remediate the source of subsurface vapors (e.g., contaminated groundwater, soil, etc.). Rather, they are designed to minimize the infiltration of subsurface vapors into a building. For consistency in implementing the techniques in residential buildings, mitigation systems should be designed and installed in accordance with the following:

- a. *Standard Practice for Installing Radon Mitigation Systems in Existing Low-rise Residential Buildings* (ASTM E-2121)

American Society for Testing and Materials (ASTM) International [ASTM E-2121-03, February 10, 2003]

This document applies to existing buildings. The purpose of this document is to provide radon mitigation contractors with uniform standards that will ensure quality and effectiveness in the design, installation, and evaluation of radon mitigation systems in detached and attached residential buildings three stories or less in height. Information on how to obtain a copy of this standard is available in Appendix E; and

- b. *Model Standards and Techniques for Control of Radon in New Residential Buildings* EPA [EPA 402-R-94-009, March 1994]

This document applies to new construction and contains information on how to incorporate radon reduction techniques and materials in residential construction. A copy of this document is provided in Appendix F.

4.2.2 System-specific recommendations

Basic design and installation recommendations for mitigation systems follow. These are based upon recommendations and requirements given by the EPA for mitigating exposures related to radon intrusion (for additional information see EPA's web site on radon at <http://www.epa.gov/iaq/radon/pubs/index.html>).

- a. *Sealing* — To improve the effectiveness of depressurization and ventilation systems and to limit the flow of subsurface vapors into the building, materials that prevent air leakage should be used, such as elastomeric joint sealant (as defined in ASTM C920-87), compatible caulks, non-shrink mortar, grouts, expanding foam, "Dranjer" drain seals, or airtight gaskets. Some effective sealants may contain volatile organic compounds; in some situations, this may be a consideration in choosing an appropriate sealing material.
- b. *Soil vapor retarder (membrane)* —
 1. To retard the infiltration of subsurface vapors into the building and enhance the performance of a SMD system, a minimum 6 mil (or 3 mil cross-laminated) polyethylene or equivalent flexible sheeting material should be used.
 2. The sheet should cover the entire floor area and be sealed at seams (with at least a 12 inch overlap) and penetrations, around the perimeter of interior piers and to the foundation walls.
 3. Enough of the sheeting should be used so it will not be pulled away from the walls when the depressurization system is turned on and the sheet is drawn down.
 4. If a membrane is installed in areas that may have future foot traffic (e.g., a dirt floor in a basement), consideration should be given to also installing a wearing surface such as sand or stone to protect the integrity of the membrane. Additionally, a layer of fine sand may be prudent beneath the membrane to protect it from penetrations by sharp objects in the dirt floor.

c. *Depressurization systems* —

1. The systems should be designed to avoid the creation of other health, safety, or environmental hazards to building occupants (e.g., backdrafting of natural draft combustion appliances).
2. The systems should be designed to minimize soil vapor intrusion effectively while minimizing excess energy usage, to avoid compromising moisture and temperature controls and other comfort features, and to minimize noise.
3. To evaluate the potential effectiveness of a SSD before it is installed, a diagnostic test (commonly referred to as a "communication" test) should be performed to measure the ability of a suction field and air flow to extend through the material beneath the slab. This test is commonly conducted by applying suction on a centrally located hole drilled through the concrete slab and simultaneously observing the movement of smoke downward into small holes drilled in the slab at locations separated from the central suction hole. A similar quantitative evaluation may also be performed by using a digital micromanometer or comparable instrument. Depending on test results, multiple suction points may be needed to achieve the desired effectiveness of the system.
4. Passive systems (i.e., a SSD system without a vent fan) are not as effective as active systems and their performance varies depending upon ambient temperatures and wind conditions. Therefore, active systems should be used to ensure exposures are being addressed.
5. The vent fan and discharge piping should not be located in or below a livable or occupied area of the building to avoid entry of extracted subsurface vapors into the building in the event of a fan or pipe leak.
6. To avoid entry of extracted subsurface vapors into the building, the vent pipe's exhaust should be
 - i. above the eave of the roof (preferably, above the highest eave of the building at least 12 inches above the surface of the roof),
 - ii. at least 10 feet above ground level,
 - iii. at least 10 feet away from any opening that is less than 2 feet below the exhaust point, and
 - iv. 10 feet from any adjoining or adjacent buildings, or HVAC intakes or supply registers.
7. Rain caps, if used, should be installed so as not to increase the potential for extracted subsurface vapors to enter the building.
8. To avoid accidental changes to the system that could disrupt its function, the depressurization system should be labeled clearly. An example of such labeling is shown in Figure 5.1.
9. A warning device or indicator should be installed to alert building occupants if the active system stops working properly. Examples of system failure warning devices and indicators include the following: a liquid gauge (e.g., a

manometer), a sound alarm, a light indicator, and a dial (needle display) gauge. The warning device or indicator should be placed where it can be easily heard or seen. The party installing the system should verify the warning device or indicator is working properly. Building occupants should be made aware of the warning device or indicator (what it is, where it is located, how it works, how to read/understand it, and what to do if it indicates the system is not working properly).

- d. *HVAC systems* — HVAC systems should be carefully designed, installed and operated to avoid depressurization of basements and other areas in contact with the soil.
- e. *Crawl space ventilation* —
 1. Ventilation systems should be designed to avoid the creation of other health, safety, or environmental hazards to building occupants (e.g., backdrafting of natural draft combustion appliances).
 2. Openings and cracks in floors above the crawl space that would permit conditioned air to pass into or out of the occupied spaces of the building, should be identified, closed and sealed.
- f. *SVE systems designed to also mitigate exposures* —
 1. The systems should be designed to avoid the creation of other health, safety, or environmental hazards to building occupants (e.g., backdrafting of natural draft combustion appliances).
 2. To avoid reentry of soil vapor into the building(s), the exhaust point should be located away from the openings of buildings and HVAC air intakes. Depending upon the concentrations of volatile chemicals in subsurface vapors and the expected mass removal rate, treatment (e.g., via carbon filters) of the SVE system effluent may be appropriate to minimize outdoor air effects.
 3. The SVE system's radius of influence should adequately address buildings requiring mitigation, as well as subsurface sources requiring remediation. If it does not, additional actions may be appropriate. For example, if the radius of influence does not completely extend beneath a building, a complementary air monitoring program may be appropriate to confirm that exposures are being addressed adequately while the SVE system is operating.

4.2.3 Technical guidance

To address exposures effectively in larger buildings, some of the same techniques used in residential buildings can be scaled up in size, number, or performance (e.g., adjustments in the size and air movement capacity of the vent pipe fan, or installation of multiple suction points through the slab instead of a single point). The design of the techniques may also be modified (e.g., installation of horizontal pipes beneath the building instead of a single suction point).

Detailed technical guidance on designing and installing mitigation systems in residential and non-residential buildings is provided in various documents, such as the following, released by the EPA and others:

- a. References provided in ASTM's E-2121 (see Appendix E for information on how to obtain a copy) and the EPA's *Model Standards and Techniques for Control of Radon in New Residential Buildings* (Appendix F);
- b. *Radon Reduction Techniques for Existing Detached Houses: Technical Guidance (Third Edition) for Active Soil Depressurization Systems*
EPA [EPA 625/R-93-011, October 1993]

This technical guidance document has been prepared to serve as a comprehensive aid in the detailed selection, design, installation, and operation of indoor radon reduction measures for existing houses based on active soil depressurization techniques. It is intended for use by radon mitigation contractors, building contractors, concerned homeowners, state and local officials and other interested persons. Copies can be ordered from the EPA's Indoor Air Quality Information Clearinghouse at 1-800-438-4318;

- c. *Protecting Your Home From Radon: A Step-by-Step Manual for Radon Reduction*
Kladder *et al.*, 1993

This manual is designed to provide sufficient information to a homeowner to make many of the basic repairs that can significantly reduce radon levels in the home;

- d. *Building Radon Out: A Step-by-Step Guide on How to Build Radon-Resistant Homes*
EPA [EPA 402-K-01-002, April 2001]

This fully illustrated guide contains all the information needed in one place to educate home builders about radon-resistant new construction (RRNC), including the following: basic questions and detailed answers about radon and RRNC, specific planning steps before installing a system, detailed installation instructions with helpful illustrations, tips and tricks when installing a system, marketing know-how when dealing with homebuyers, and architectural drawings. This document is available at the EPA's web site: <http://www.epa.gov/iaq/radon/pubs/index.html>; and

- e. *Radon Prevention in the Design and Construction of Schools and Other Large Buildings*
EPA [EPA 625-R-92-016, June 1994]

It is typically easier and much less expensive to design and construct a new building with radon-resistant and/or easy-to-mitigate features, than to add these features after the building is completed and occupied. Specific guidelines on how to incorporate radon prevention features in the design and construction of schools and other large buildings are detailed in this manual. Copies can be ordered from the EPA's Indoor Air Quality Information Clearinghouse at 1-800-438-4318. This document is also available on the EPA Office of Research and Development's web site: <http://www.epa.gov/ORD/NRMRL/pubs/625r92016/625r92016.htm>.

4.3 Post-mitigation or confirmation testing

Once a mitigation system is installed, its effectiveness and proper installation should be confirmed. The party that installed the system should conduct post-mitigation testing and for developing a post-mitigation testing plan. Minimum objectives for post-mitigation testing associated with specific mitigation methods are provided in the following

subsections. All post-mitigation testing activities should be documented and reported to the agencies.

4.3.1 SSD systems with sealing

- a. Reasonable and practical actions should be taken to identify and fix leaks. With the depressurization system operating, smoke tubes are used to check for leaks through concrete cracks, floor joints, and at the suction point. Any leaks identified should be resealed until smoke is no longer observed flowing through the opening.
- b. Once a depressurization system is installed, its operation may compete with the proper venting of fireplaces, wood stoves and other combustion or vented appliances (e.g., furnaces, clothes dryers, and water heaters), resulting in the accumulation of exhaust gases in the building and the potential for carbon monoxide poisoning. Therefore, in buildings with natural draft combustion appliances, the building should be tested for backdrafting of the appliances. Backdrafting conditions should be corrected before the depressurization system is placed in operation.
- c. The distance that a pressure change is induced in the sub-slab area (i.e., a pressure field extension test) should be conducted. Analogous to a communication test, this test is commonly conducted by operating the depressurization system and simultaneously observing the movement of smoke downward into small holes (e.g., 3/8 inch) drilled through the slab at sufficient locations to demonstrate that a vacuum is being created beneath the entire slab. A similar quantitative evaluation may also be performed by using a digital micromanometer or comparable instrument. If adequate depressurization is not occurring, the reason (e.g., improper fan operation) should be identified and corrected.
- d. Adequate operation of the warning device or indicator should be confirmed.
- e. Except as indicated below, post-mitigation indoor and outdoor air sampling should be conducted in all buildings where pre-mitigation samples were collected and in all buildings where physical data suggest possible impediments to comprehensive sub-slab communication of the depressurization system (i.e., locations with wet or dense sub-slab soils, multiple foundations and footings, minimal pressure differentials between the interior and sub-slab). Generally, indoor and outdoor air sampling locations, protocols and analytical methods should be consistent between pre-mitigation and post-mitigation sampling, where applicable. In buildings with basements, post-mitigation indoor air sampling from the basement alone (i.e., without a concurrent indoor air sample from the first floor) is recommended in most circumstances.

Typically, post-mitigation sampling should be conducted no sooner than 30 days after installing a depressurization system. If the system is installed outside of the heating season or at the end of a season, post-mitigation air sampling may be postponed until the heating season.

In cases of widespread mitigation due to vapor contamination and depending upon the basis of making decisions (e.g., a "blanket mitigation" approach within a specified area of documented vapor contamination [Section 3.3.1]), a representative number of buildings from an identified study area, rather than each building, may be

sampled. Prior to implementation, this type of post-mitigation sampling approach should be approved by State agency personnel.

In newly constructed buildings, a site-specific and building-specific indoor air sampling plan is recommended due to potential interferences caused by the off-gassing of volatile chemicals in new building materials (e.g., paints, carpets, furniture, etc. [Section 1.4]). In these situations, if indoor air sampling is appropriate samples should be

- i. collected while the system is operational but before potentially interfering factors are brought into the building,
- ii. analyzed for a targeted list of volatile chemicals based on previous environmental sampling (e.g., groundwater, soil, soil vapor, etc.), and/or
- iii. collected while the system is operational but after potentially interfering factors have had an opportunity to off-gas.

If post-mitigation sampling results do not indicate a significant decrease in the concentrations of volatile chemicals previously believed to be present in the indoor air due to soil vapor intrusion, the reason (e.g., indoor or outdoor sources, improper operation of the mitigation system, etc.) should be identified and corrected as appropriate.

4.3.2 SMD systems with soil vapor retarder

- a. Reasonable and practical actions should be taken to identify and fix leaks. With the depressurization system operating, smoke tubes are used to check for leaks in the membrane at seams, edge seals and at locations where the sheet was sealed around obstructions. Any leaks identified should be resealed until smoke is no longer observed flowing through the opening.
- b. Backdrafting conditions should be evaluated and corrected [Section 4.3.1].
- c. Adequate operation of the warning device or indicator should be confirmed.
- d. Post-mitigation indoor and outdoor air testing should be conducted in buildings where pre-mitigation samples were collected [as discussed in Section 4.3.1].

4.3.3 HVAC modifications

- a. Check the building for positive pressure conditions (e.g., verify a pressure controller is maintaining the desired pressure differential and/or measure the pressure differential between the sub-slab and indoor air by using field instruments).
- b. Backdrafting conditions should be evaluated and corrected [Section 4.3.1].
- c. Adequate operation of the warning device or indicator, if applicable, should be confirmed.
- d. Post-mitigation indoor and outdoor air testing should be conducted in buildings where pre-mitigation samples were collected [Section 4.3.1].

4.3.4 Crawl space ventilation and sealing

- a. Reasonable and practical actions should be taken to identify and fix leaks. With the ventilation system operating, smoke tubes are used to check for leaks in openings and cracks in floors above the crawl space that were sealed during installation of the system. Any leaks identified should be resealed until smoke is no longer observed flowing through the opening.
- b. Backdrafting conditions should be evaluated and corrected [Section 4.3.1].
- c. Adequate operation of the warning device or indicator, if applicable, should be confirmed.
- d. Post-mitigation indoor and outdoor air testing should be conducted in buildings where pre-mitigation samples were collected [as discussed in Section 4.3.1].

4.3.5 SVE systems designed to also mitigate exposures

- a. Backdrafting conditions should be evaluated and corrected [Section 4.3.1].
- b. The distance that a pressure change is induced in the sub-slab area should be conducted. This may be done by operating the SVE system and simultaneously observing the movement of smoke downward into small holes (e.g., 3/8 inch) drilled through the building's slab at sufficient locations to demonstrate that a vacuum is being created beneath the entire slab.
- c. Adequate operation of the warning device or indicator, if applicable, should be confirmed.
- d. Post-mitigation indoor and outdoor air testing should be conducted in buildings where pre-mitigation samples were collected [Section 4.3.1].

4.4 Operation, maintenance and monitoring of mitigation systems

When mitigation systems are implemented at a site, the operation, maintenance and monitoring (OM&M) protocols for the systems should be included in a site-specific site management plan (formerly referred to as operation, maintenance and monitoring plan). The party that installed the system should conduct OM&M activities and should develop the site management plan. Recommendations for minimum OM&M activities associated with specific mitigation methods are provided in the following subsections. Also included is a discussion of non-routine maintenance. All routine and non-routine OM&M activities should be documented and reported to the agencies.

4.4.1 SSD and SMD systems

Routine maintenance should commence within 18 months after the system becomes operational, and should occur every 12 to 18 months thereafter. Based upon a demonstration of the system's reliability, the State recommends that, if a different frequency is desired, a petition describing the alternative frequency and the reasons that frequency is preferred be submitted to the State. Any comments the State may have on the petition should be considered before the frequency is altered.

During routine maintenance, the following activities (at a minimum) should be conducted:

- a. a visual inspection of the complete system (e.g., vent fan, piping, warning device or indicator, labeling on systems, soil vapor retarder integrity, etc.),
- b. identification and repair of leaks [Sections 4.3.1 and 4.3.2], and
- c. inspection of the exhaust or discharge point to verify no air intakes have been located nearby.

As appropriate preventative maintenance (e.g., replacing vent fans), repairs and/or adjustments should be made to the system to ensure its continued effectiveness at mitigating exposures related to soil vapor intrusion. The need for preventative maintenance will depend upon the life expectancy and warranty for the specific part, as well as visual observations over time. The need for repairs and/or adjustments will depend upon the results of a specific activity compared to that obtained when system operations were initiated.

If significant changes are made to the system or when the system's performance is unacceptable, the system may need to be redesigned and restarted. Many, if not all, of the post-mitigation testing activities, as described in Sections 4.3.1 and/or 4.3, may be appropriate. The extent of such activities will primarily depend upon the reason for the changes and the documentation of sub-slab depressurization.

Generally, air monitoring is not recommended if the system has been installed properly and is maintaining a vacuum beneath the entire slab.

In addition to the routine OM&M activities described here, the building's owner and tenants are given information packages that explains the system's operation, maintenance and monitoring [Section 5.6]. Therefore, at any time during the system's operation, the building's owner or tenants may check that the system is operating properly.

4.4.2 Other mitigation systems

For other mitigation systems (e.g., HVAC modifications, crawl space ventilation, etc.), routine maintenance activities are generally comparable to post-mitigation testing activities [Section 4.3]. Activities typically include a visual inspection of the complete system, and identification and repair of leaks. System performance checks, such as air stream velocity measurements of ventilation systems, also should be performed.

As appropriate, preventative maintenance (e.g., replacing filters, cleaning lines, etc.), repairs and/or adjustments should be made to the system to ensure its continued effectiveness at mitigating exposures related to soil vapor intrusion. If significant changes are made to the system or when the system's performance is unacceptable, redesigning and restarting the system may be appropriate [Section 4.4.1].

Air monitoring, such as periodic sub-slab vapor, indoor air and outdoor air sampling, may be appropriate to determine whether existing building conditions are maintaining the desired mitigation endpoint and to determine whether changes are appropriate. The type and frequency of monitoring is determined based upon site-specific and building-specific conditions, taking into account applicable environmental data, building operating conditions, and the mitigation method employed.

4.4.3 Non-routine maintenance

Non-routine maintenance may also be appropriate during the operation of a mitigation system. Examples of such situations include the following:

- a. the building's owners or occupants report that the warning device or indicator indicates the mitigation system is not operating properly;
- b. the mitigation system becomes damaged; or
- c. the building has undergone renovations that may reduce the effectiveness of the mitigation system.

Activities conducted during non-routine maintenance visits will vary depending upon the reason for the visit. In general, building-related activities may include examining the building for structural or HVAC system changes, or other changes that may affect the performance of the depressurization system (e.g., new combustion appliances, deterioration of the concrete slab, or significant changes to any of the building factors listed in Table 1.2). Depressurization system-related activities may include examining the operation of the warning device or indicator and the vent fan, or the extent of sub-slab depressurization. Repairs or adjustments should be made to the system as appropriate. If appropriate, the system should be redesigned and restarted [Section 4.4.1].

4.5 Termination of mitigation system operations

Mitigation systems should not be turned off, until the State receives, and has had the opportunity to comment on, a proposal to turn off mitigation systems. The party seeking to turn off the mitigation systems should consider any comments the State may have on the proposal, except in emergency situations. Systems should remain in place and operational until they are no longer needed to address current or potential exposures related to soil vapor intrusion. This determination should be based upon several factors, including the following:

- a. subsurface sources (e.g., groundwater, soil, etc.) of volatile chemical contamination in subsurface vapors have been remediated based upon an evaluation of appropriate post-remedial sampling results;
- b. residual contamination, if any, in subsurface vapors is not expected to affect indoor air quality significantly based upon soil vapor and/or sub-slab vapor sampling results;
- c. residual contamination, if any, in subsurface vapors is not affecting indoor air quality when active mitigation systems are turned off based upon indoor air, outdoor air and sub-slab vapor sampling results at a representative number of buildings; and
- d. there is no "rebound" effect for which additional mitigation efforts would be appropriate observed when the mitigation system is turned off for prolonged periods of time. This determination should be based upon indoor air, outdoor air and/or sub-slab vapor sampling from the building over a time period, determined by site-specific conditions.

Given the prevalence of radon throughout the State of New York, consideration should be given to leaving the system in place and operating to address exposures related to radon intrusion after concurrence is reached that the system is no longer needed to mitigate exposures related to soil vapor intrusion. This action should be done only with permission of the property owner and after the property owner is aware of their responsibilities in

operating, monitoring and maintaining the system for this specific purpose. If the property owner declines the offer, the system should be shut down and, if requested, removed in a timely manner.

4.6 Annual certification and notification recommendations

Mitigation systems are considered engineering controls, defined as any physical barrier or method employed to

1. actively or passively contain, stabilize, or monitor hazardous waste or petroleum,
2. restrict the movement of hazardous waste or petroleum to ensure the long-term effectiveness of remedial actions, or
3. eliminate potential exposure pathways to hazardous waste or petroleum.

Therefore, depending upon the remedial program, submission of an annual certification to the State may be required. This certification must be prepared and submitted by a professional engineer or environmental professional and affirm that the engineering controls are in place, are performing properly and remain effective. This requirement of certification remains in effect until the State provides notification, in writing, that this certification is no longer needed.

If a property owner declines a mitigation system, the party responsible for arranging the design and installation of the system should renew the offer on an annual basis, unless they demonstrate environmental conditions have changed such that a system is no longer needed.

LaBELLA
LaBella Associates, P.C.

300 State Street
Rochester, New York 14614

Appendix 3

DER-13 / Strategy For Evaluating Soil Vapor Intrusion at Remedial Sites in New York

New York State Department of Environmental Conservation

DEC Program Policy

Issuing Authority: Carl Johnson

Title: Deputy Commissioner
Office of Air and Waste Management

Date Issued: October 18, 2006

Latest Date Revised:

I. SUMMARY:

Improvements in analytical techniques and knowledge gained from site investigations in New York and other states has led to an increased awareness of soil vapor as a medium of concern and of the potential for exposures from the soil vapor intrusion pathway. Based on this additional information, New York is currently re-evaluating previous assumptions and decisions regarding the potential for soil vapor intrusion exposures at sites. As a result, all past, current, and future contaminated sites will be evaluated to determine whether these sites have the potential for exposures related to soil vapor intrusion. These include all Resource Conservation and Recovery Act (RCRA) Corrective Action sites, inactive hazardous waste disposal sites (State Superfund), Voluntary Cleanup Program sites, Brownfield Cleanup Program sites, and Environmental Restoration Program sites. New York's approach to evaluating the soil vapor intrusion pathway at remedial sites is described in two complementary documents: this New York State Department of Environmental Conservation (Department) Program Policy and the New York State Department of Health (DOH) "Guidance for Evaluating Soil Vapor Intrusion in the State of New York." The combined goal of these documents is to conduct soil vapor intrusion evaluations as efficiently and effectively as possible at remedial sites. This policy describes the approach by which the Agencies (the Department, in consultation with the DOH) will address soil vapor intrusion at remedial sites. The approach presented reflects the following:

1. Soil vapor intrusion evaluations are among the Agencies' top priorities;
2. the likelihood of soil vapor intrusion-related exposures varies from site to site;
3. the number of sites at which soil vapor intrusion evaluations are warranted is quite large; and
4. revisiting this issue concurrently at all volatile chemical sites where remedial or corrective actions have been implemented is not feasible.

The Department is evaluating soil vapor intrusion at all sites currently in the pre-remedial decision phase and will evaluate soil vapor intrusion at all future sites during the remedial investigation phase. The identification and prioritization procedures described in Section V.2 of this policy were used to identify past sites with the highest potential for soil vapor intrusion. Past sites are defined as sites with known or suspected volatile organic compound (VOC) contamination where remedial decisions for part or all of the site were made prior to January 1, 2003.

II. POLICY:

The soil vapor intrusion pathway will be evaluated at all contaminated sites in New York. This includes sites that are currently being reviewed under one of the Department of Environmental Conservation's (DEC's) remedial programs which include sites that are reviewed in the future as well as sites where remedial decisions have already been made.

III. PURPOSE AND BACKGROUND:

Purpose

This guidance, coupled with the DOH "Guidance for Evaluating Soil Vapor Intrusion in the State of New York" serve differing, but complementary purposes. The combined purpose of the documents is to develop a process to conduct soil vapor intrusion evaluations as efficiently and effectively as possible at all remedial sites.

This Department strategy describes the process by which the Agencies will prioritize remedial sites for soil vapor intrusion evaluations. The approach presented reflects the following:

1. Soil vapor intrusion evaluations are among the Agencies' top priorities;
2. the likelihood of soil vapor intrusion-related exposures varies from site to site;
3. the number of sites at which soil vapor intrusion evaluations are warranted is quite large, and
4. revisiting this issue concurrently at all volatile chemical sites where remedial or corrective actions have been implemented is not feasible.

The companion DOH document provides general guidance for parties evaluating soil vapor intrusion in New York State. Specifically, the DOH document provides guidance on the following:

1. Collecting appropriate and relevant data;
2. evaluating investigation data;
3. selecting appropriate actions to address potential and current human exposures;
4. implementing soil vapor intrusion mitigation methods; and
5. carrying out community outreach.

Taken together, the two documents provide a basis for deciding how, where, and when to conduct soil vapor intrusion evaluations. Because the evaluation of soil vapor intrusion is an evolving process, the Agencies anticipate that knowledge gained from the investigation and mitigation of soil vapor intrusion sites in New York and other states will be used to refine and improve our approach to addressing soil vapor intrusion. Consequently, these documents are viewed as dynamic tools that may be refined and revised over time.

Background

Soil vapor intrusion is the migration of volatile chemicals (in vapor form) from the subsurface into overlying or adjacent buildings. Volatile chemicals can be found in buried wastes, contaminated soils, and/or contaminated groundwater and can emit vapors that may migrate through subsurface soils into buildings. Typically, if vapors migrate into buildings, the levels are relatively low and health concerns,

if any, relate to chronic effects based on long term exposure to low chemical concentrations. In extreme cases, the vapors may accumulate in buildings to levels that may pose near-term safety hazards (e.g., explosion), acute health effects, or aesthetic problems (e.g., odors). In the past, soil vapor intrusion was considered to be a phenomenon caused by soil vapors emanating from a source of volatile chemicals (separate-phase or sorbed) located adjacent to or directly beneath the foundation of an occupied building. Investigation of potential human exposure to these volatile chemicals generally involved soil vapor surveys and indoor air sampling. If an off-site dissolved contaminant plume flowing beneath a home or business was deep, the assumption was that the concentrations of any vapors entering buildings above would be so low by the time it reached the basement level that it would not represent an indoor air concern.

Although the Agencies may have previously evaluated the soil vapor pathway at a site, improvements in analytical techniques and knowledge gained from the investigation of sites in New York and other states has led to an increased awareness regarding soil vapor as a media of concern and the potential for exposures from the soil vapor intrusion pathway. Based on this additional information, New York is currently re-evaluating previous assumptions and decisions regarding the potential for soil vapor intrusion exposures at sites. The result is that additional work may be required to investigate and, where appropriate, remediate sites. This includes sites that are in the operation, maintenance and monitoring phase or have been delisted.

Based on a review of the Division of Environmental Remediation's (DER's) database of remediation sites, as well as information from the Division of Solid and Hazardous Materials (DSHM), it is estimated that solvents or other volatile organic compounds have been disposed at over 750 sites (chlorinated and nonchlorinated), resulting in contaminated soil or groundwater. Many of these sites have already been remediated and are either in the long-term monitoring phase or were closed once remedial objectives established for the cleanup were met. However, based on recent evidence and a better understanding of soil vapor intrusion and mobility, the soil vapor intrusion pathway may need to be re-evaluated at these sites since current exposures related to soil vapor intrusion may exist despite remedial actions having already been completed.

IV. RESPONSIBILITY:

This policy was jointly developed by staff from the DER, DSHM, and DOH. Responsibility for interpreting and updating this document will reside with the DER.

V. PROCEDURE:

This policy divides the universe of sites into two groups: 1) sites where remedial decisions have not yet been made (ongoing sites) and, 2) sites where remedial decisions for part or all of the site were made prior to January 1, 2003 (past sites).

1. Evaluation of Ongoing Sites

For ongoing sites where final remedial decisions have not been made, the soil vapor intrusion pathway will be evaluated as a component of the investigation. This is consistent with the State's approach to any other media (e.g., groundwater and soil). Guidance on evaluating the soil vapor intrusion pathway in New York (e.g., investigation procedures, data interpretation, and mitigation or remediation

alternatives) is presented in the DOH companion document: “Guidance for Evaluating Soil Vapor Intrusion in the State of New York.” Based on the findings of the soil vapor intrusion evaluation, appropriate decisions will be made and will be included as part of the remedy selected for the site, or as an interim remedial measure, if warranted.

2. Evaluation of Past Sites

All past sites will be evaluated for the potential for soil vapor intrusion. Evaluations at past sites will be completed in the same manner that ongoing sites are evaluated in accordance with “Guidance for Evaluating Soil Vapor Intrusion in the State of New York.” Priority will be placed upon those sites where CVOCs (chlorinated volatile organic compounds) were disposed of or detected in soil or groundwater. CVOCs include many of the common organic solvents used at former industrial sites and dry cleaning facilities (e.g., trichloroethene, tetrachloroethene). The Department is targeting sites with CVOC contamination first (as opposed to non-chlorinated volatile chemicals) because they are found at the vast majority of contaminated sites, they do not readily biodegrade, and they may accumulate indoors without being noticed by the occupant because of their high odor threshold. Review of our records has generated a list of 421 sites where CVOCS were involved.

The Department recognizes that although non-chlorinated VOCs (such as benzene and naphthalene) also have some potential for soil vapor intrusion, they represent less of a priority in the evaluation of past sites for two reasons: non-chlorinated VOCs readily biodegrade in the presence of oxygen, which is generally available in the vadose zone (zone above the groundwater table) through which contaminants must pass before entering a basement or crawl space; and non-chlorinated volatile compounds also generally have an odor or taste when they are present in drinking water or breathing space and are noticed by impacted individuals. Sites having these characteristics are currently addressed as they are identified. For these reasons, action at the majority of sites with non-chlorinated VOCs will be deferred while the results of further monitoring are evaluated and used to verify these assumptions. The priority of non-chlorinated VOC sites may be modified at a later date based on new information and a revised conceptual understanding of soil vapor intrusion.

The Department, the DOH, and the United States Environmental Protection Agency (USEPA) will either lead or provide oversight to the soil vapor intrusion evaluation. The USEPA has agreed to be the lead at all former and current sites on the National Priorities List (NPL) that are located in New York State. The Department will be the lead at all remaining sites. The Department will seek to have the parties responsible for contaminating the site conduct soil vapor intrusion evaluations. Attachment 1 depicts who will lead the evaluation of the different groups of sites. Letters have been sent to the responsible parties asking them to perform the evaluation and provide the Department with any data or information pertaining to the potential for soil vapor intrusion. At remedial sites where responsible parties are unwilling or unable to conduct a soil vapor intrusion evaluation, or there are no responsible parties to do so, the Department will proceed with the evaluation. The Department will subsequently seek to recover the costs incurred as part of that evaluation where appropriate and authorized by law.

Because it is not feasible to conduct soil vapor intrusion evaluations concurrently at all sites where the Department is responsible for leading or overseeing the evaluation, a process to prioritize the evaluation of past sites has been developed. The process involves an initial screening step followed by a scoring and ranking step. The prioritization process was developed to assist the Agencies in conducting soil vapor intrusion investigations as effectively and efficiently as possible at past remedial sites.

Initial Screening

The initial screening process was designed to be applied with a general knowledge of the site and the chemicals known or reasonably suspected to be present in the subsurface. It acknowledges that soil vapor intrusion may be driven by contamination within the groundwater, within the soil or both. Attachment 2 is a flowchart that depicts the decision logic used to screen the sites.

Ranking and Prioritization of Department-Lead Sites

The following procedure applies to the prioritization of Department-lead sites where responsible parties are unwilling or unable to conduct a soil vapor intrusion evaluation, or there are no responsible parties to do so. The ranking criteria were chosen based on site conditions that are believed to play a significant role in the soil vapor intrusion pathway. The following four criteria were chosen:

1. Total chlorinated volatile organic compound (CVOC) concentration
2. Depth to contamination
3. Soil characteristics
4. Land use at and adjacent to the site above impacted soil or groundwater

A set of weighting factors were then assigned to each of the criteria. The weighting factors (shown on the attached score sheets) for the various criteria were selected in order to distinguish the potential for soil vapor intrusion and to establish separation between sites on the list. For example, a site where the depth to contaminated groundwater is between 15 and 50 feet below grade would be assigned a weighting factor of 4 for that criterion but a site where the depth to groundwater is greater than 60 feet would only be assigned a weighting factor of 1 because depth to groundwater is considered inversely proportional to the potential for soil vapor intrusion. Additional sampling points may be added, or subtracted in some cases, based on such site conditions as proximity to sensitive receptors (e.g., daycare facilities, schools, and hospitals), presence of grossly contaminated soil or NAPL, or current information pertaining to the completion of remedial activities.

Separate score sheets, one for soil (Attachment 3) and one for groundwater (Attachment 4), have been developed to help in the prioritization of past sites. Separate sheets have been developed because the mechanism for soil vapor intrusion (either soil driven or groundwater driven) are not necessarily related. Initially, sites with soil contamination and sites with groundwater contamination will be prioritized separately. As we move forward with soil vapor intrusion investigations at these older sites, we will use the new information to assess whether the assigned weighting factors serve as a useful tool for predicting whether soil vapor intrusion is likely to be a significant exposure pathway at a site. Adjustments to the weighting factors may be made to improve their usefulness as predictors.

Score sheets were completed for each of the past sites in order to prioritize the sites. The sources of information that were used to complete the score sheets were Records of Decision (ROD), Statements of Basis (SOB), Facility Fact Sheets, and other summary-level data sources. After reviewing the available information, the Department ranked each of the sites.

The list of sites generated through the identification and prioritization process outlined above was cross-checked with other efforts that have identified sites with the potential for soil vapor intrusion issues, such as those brought to the Department's attention by county health departments or citizens groups. As a final measure, staff were requested to review the prioritized list and confirm the information used to score and rank the sites.

Evaluation process

The process of conducting a soil vapor intrusion evaluation will begin with a review of available historical data that was generated since the remedial decision was made. In some cases, there may be sufficient historical data to evaluate the soil vapor intrusion pathway without further investigation. For instance, where historical data indicate that VOCs are no longer present, either on-site or off-site, and the Agencies concur that there is no potential for soil vapor intrusion, then the soil vapor intrusion evaluation will be deemed complete.

At sites where it is determined that further investigation is required, it may be necessary to collect any or all of the following samples: groundwater, soil vapor, sub-slab vapor, and indoor and outdoor air. Site-specific vapor investigations performed by the Department will be planned and implemented in accordance with the DOH guidance document.

Schedule

The Agencies' goal is to evaluate the past sites for soil vapor intrusion impacts as quickly as possible. Attachment 1 outlines who will conduct these evaluations. For those sites that the U.S. EPA has agreed to lead, the evaluations will be completed according to a schedule set by the U.S. EPA. At sites where a responsible party has been identified, the Department has requested that they complete the evaluations as soon as possible. Agency staff will work with the responsible parties to facilitate this effort. For the remaining sites, the Department will proceed with the evaluations generally in priority order utilizing the process described in this policy. In general, sites where the perceived potential for soil vapor intrusion is greatest (corresponding to the sites with the highest score), will be addressed first. Soil vapor intrusion evaluations have already commenced. As we gain experience in performing soil vapor intrusion evaluations, this experience will be applied to future investigations as well as be incorporated into future State guidance.

VI. RELATED REFERENCES:

New York State Department of Health (DOH) "Guidance for Evaluating Soil Vapor Intrusion in the State of New York." http://www.health.state.ny.us/nysdoh/gas/svi_guidance/index.htm

Attachments:

Attachment 1 - Vapor Intrusion Evaluation of Legacy Sites - Who Will Conduct The Evaluation ?

Attachment 2 - Vapor Intrusion Screening Approach Used to Prioritize Soil Vapor Intrusion Evaluations of " DEC - Lead" Legacy Sites

Attachment 3 - Soil Weighting Factors Used to Prioritize " DEC - Lead" Legacy Sites For Soil Vapor Intrusion Evaluations

Attachment 4 - Groundwater Weighting Factors Used to Prioritize " DEC - Lead" Legacy Sites For Soil Vapor Intrusion Evaluations

Attachment 1

Vapor Intrusion Evaluations of Legacy Sites

Who Will Conduct The Evaluations?

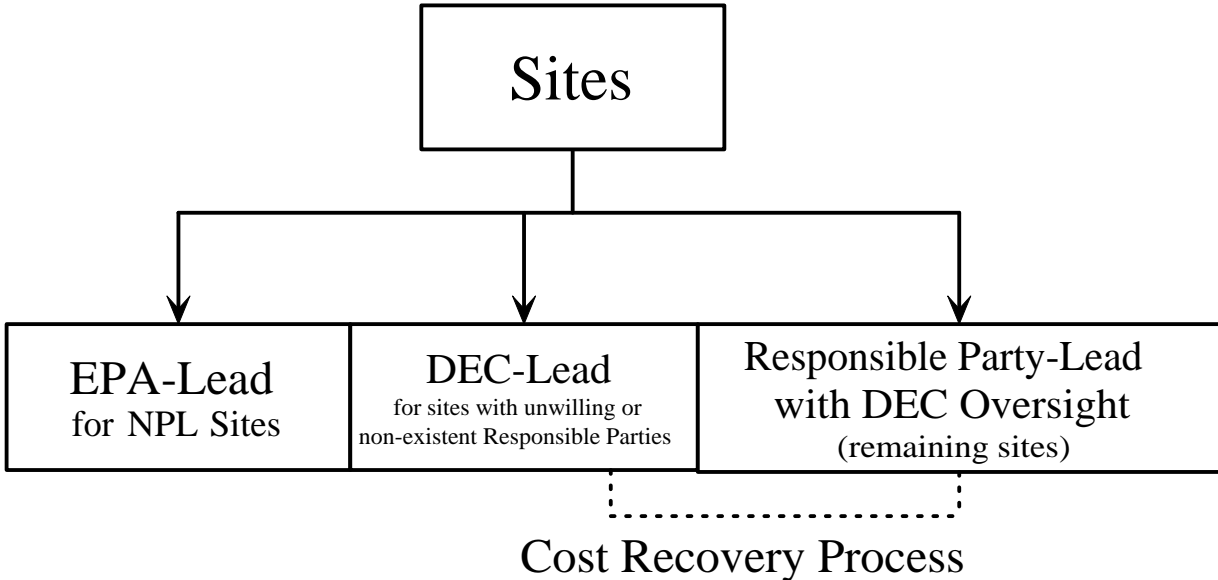

Attachment 2
Vapor Intrusion Screening Approach
Used to Prioritize
Soil Vapor Intrusion Evaluations
of "DEC-Lead" Legacy Sites

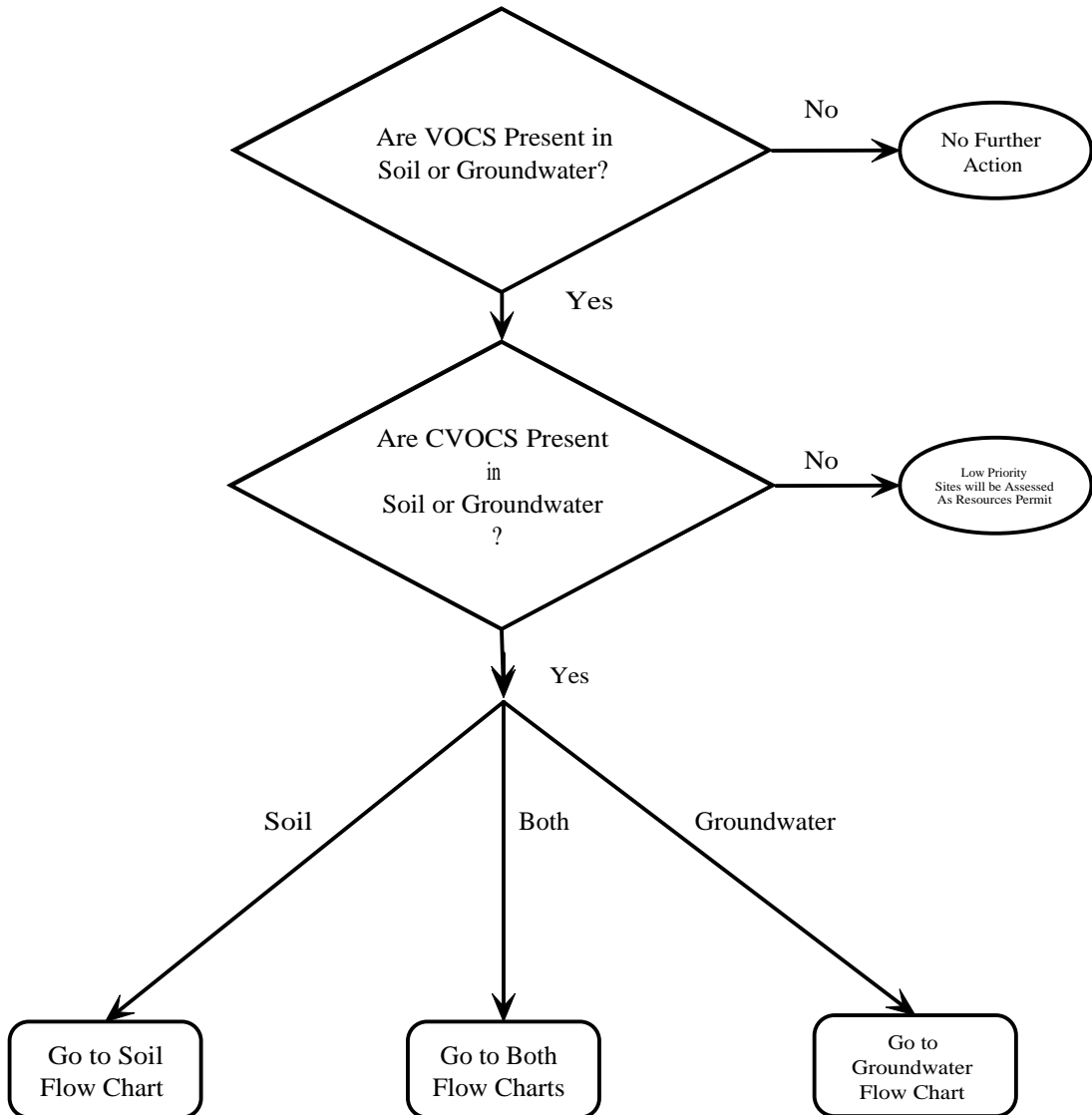

Attachment 3

Soil Weighting Factors

Used to Prioritize "DEC-Lead" Legacy Sites For Soil Vapor Intrusion Evaluations

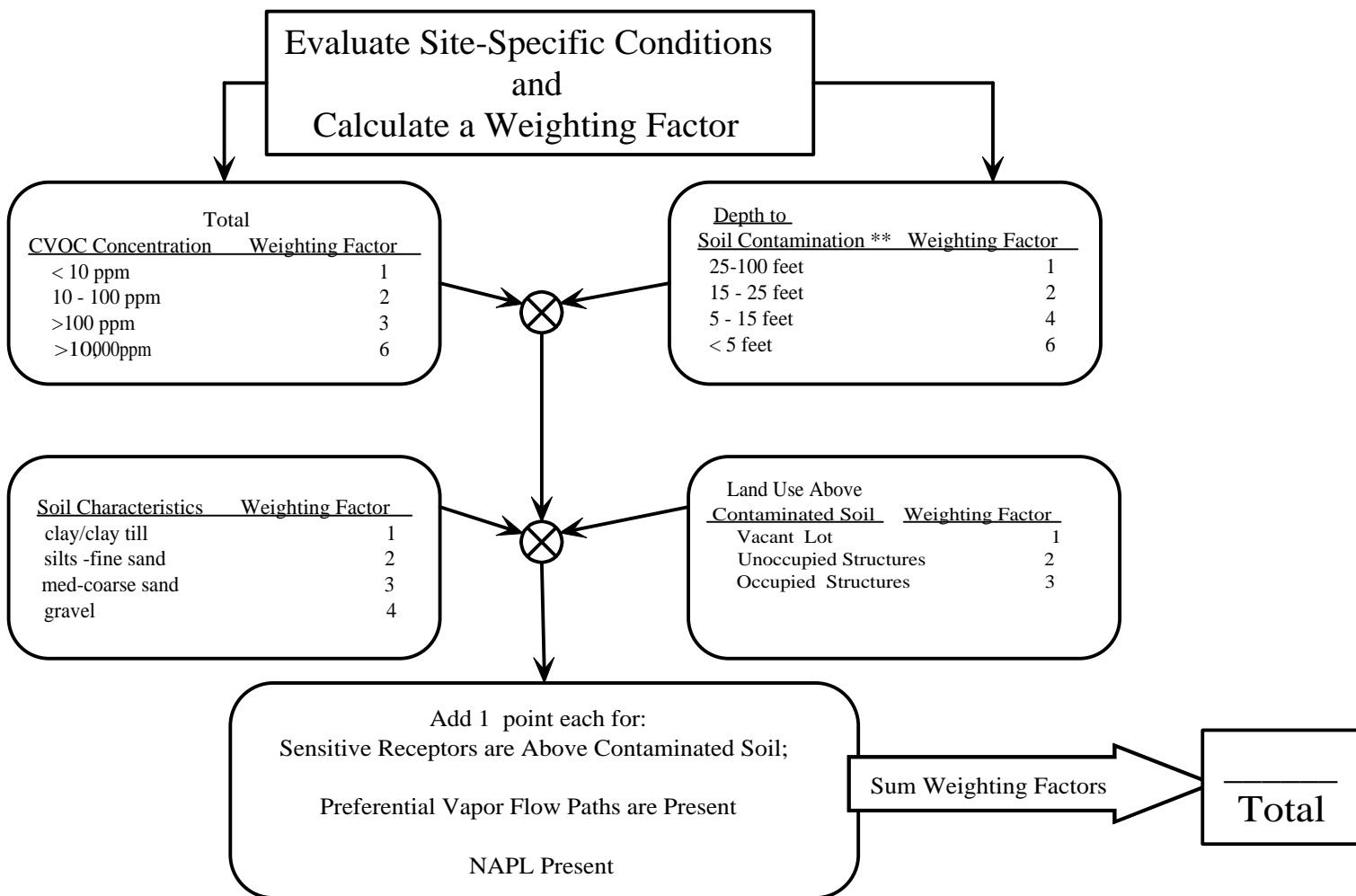

Note: Sensitive Receptors = (day care centers, elder care facilities, hospital, etc.)
 Preferential Flow Paths = (pipes & pipe bedding, joints and fractures, sumps and other penetrations)

** The weighting factor for the depth to soil can be adjusted upward or downward to account for the stratigraphic distribution of the contamination and the building types that sit over it. (For example, shallow soil contamination in areas where there are no buildings should be given a low weighting; soil contamination at foundation depths should be given a higher weighting if buildings that sit over it have basements.)

Attachment 4

Groundwater Weighting Factors Used to Prioritize "DEC-Lead" Legacy Sites For Soil Vapor Intrusion Evaluations

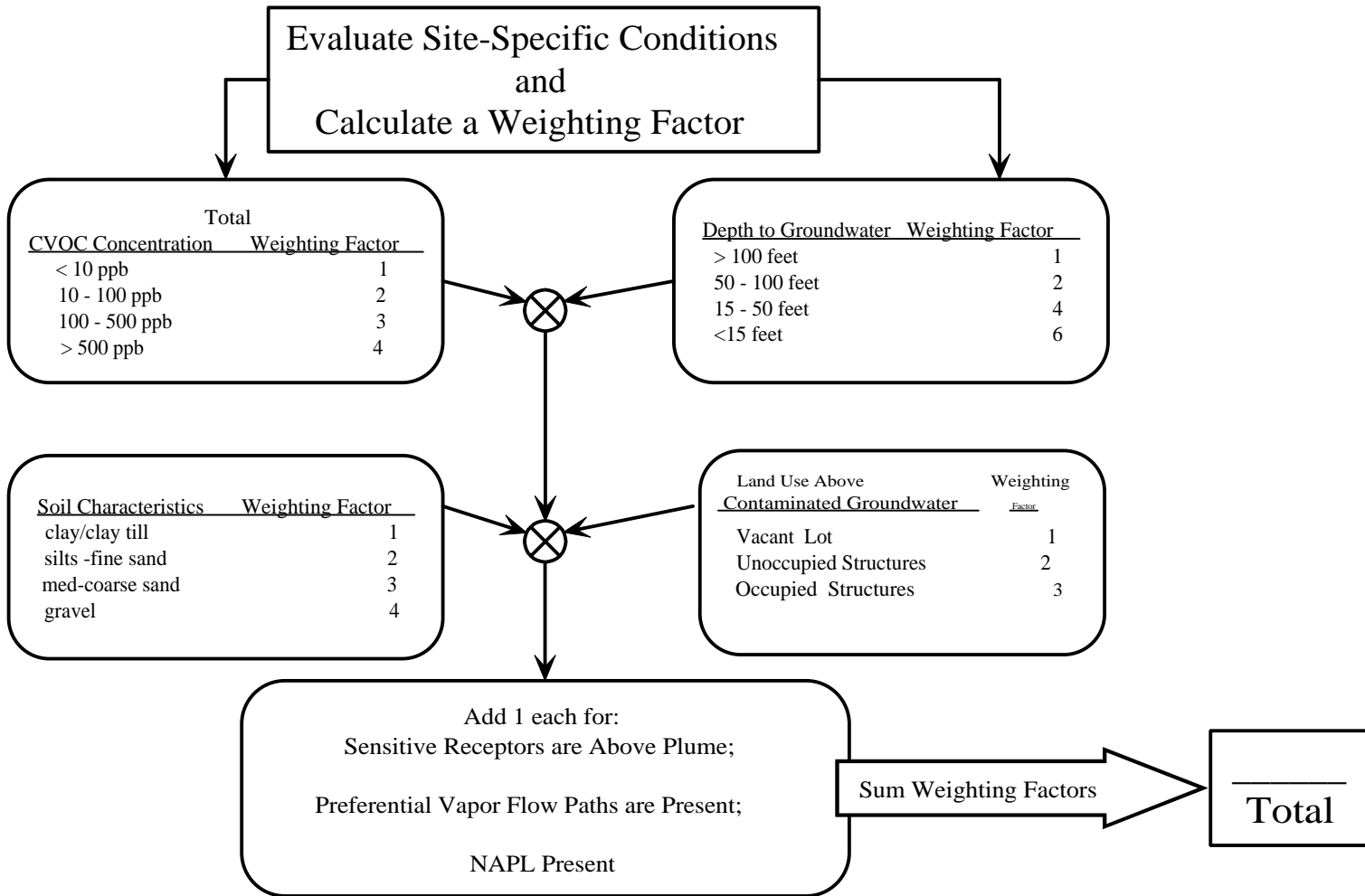

Note: Sensitive Receptors = (day care centers, elder care facilities, hospital, etc.)

Preferential Flow Paths = (pipes & pipe bedding, joints and fractures, sumps and other penetrations)

SUMMARY OF REVIEW AND RESOLUTION OF MAJOR ISSUES AND COMMENTS

Program Policy DER-13: Strategy for Prioritizing Soil Vapor Intrusion Evaluations at Remedial Sites in New York

The draft Program Policy (DER 13) was published in the Environmental Notice Bulletin (ENB) on November 24, 2004. The original public comment period was extended for 30 days and ended on January 24, 2005, during which time over 130 comments were received (including five from the Office of the Attorney General marked confidential). In order to summarize the comments, they were organized by category.

Many of the technical comments are answered simply by referring the commentators to an appropriate section of the draft Department of Health (DOH) vapor guidance, which was released for public comment in February 2005. The following table summarizes the scope of the major comments and the Department's responses to each of the major issues.

Issue	Summary of Comment	Resolution
100 ft distance	Questioned the technical basis for screening out sites from further investigation that are more than 100 ft from an occupied structure.	The Department has decided to revise the draft policy and not apply a generic threshold criterion based on distance from a source of contamination to an occupied structure. At this point in time, there is not sufficient evidence to support setting such a criterion.
Access to database	Requests for public access to site-specific information compiled by the Department and used to rank and prioritize past sites.	Most of the information utilized in scoring and ranking the sites is already available to the public through the Department web site (http://www.dec.state.ny.us/cfm/extapps/derfoil/index.cfm). Detailed data on specific sites can be reviewed at the local document repositories located in the impacted communities. These documents include Remedial Investigation Reports, Feasibility Study Reports, Records of Decision, and Site Fact Sheets. Information relative to the location of these repositories can be obtained by sending an email to the Division (derweb@gw.dec.state.ny.us).

**Program Policy DER-13: Strategy for Prioritizing Soil Vapor Intrusion Evaluations at Remedial Sites in New York
Summary of Review and Resolution of Major Issues and Comments**

Issue	Summary of Comment	Resolution
Applicability of OSHA	Concern expressed that the Agencies' indoor air quality guidelines will supersede existing OSHA requirements (i.e., will the State defer to OSHA for non-residential or occupational exposures?)	Whether or not OSHA regulations apply at a particular site is beyond the scope of this policy. Occupational exposures are discussed in the draft DOH guidance document (Section 2.12). The document: Guidance for Evaluating Soil Vapor Intrusion in the State of New York - Working Draft and the response to comments: Response to Comments Received on the Public Comment Draft of the New York State Department of Health's Guidance for Evaluating Soil Vapor Intrusion in the State of New York are available on the DOH web site at http://www.health.state.ny.us/environmental/indoors/vapor_intrusion/index.htm
Community participation	Need for additional public outreach after Department completes the proposed list for further investigation. When investigation is complete the public should be made aware of sampling results.	No further public input on the proposed list of legacy sites is being solicited. All sites on the list will be evaluated. The public will be made aware of the evaluations as they proceed and the results of the evaluation. Building specific results will be provided to occupants and owners of buildings sampled.
Consideration of background	Background (ambient outdoor and indoor) sources should be considered when evaluating soil vapor intrusion.	Consideration of background sources and how they impact the decisions made at a particular site is beyond the scope of this policy and is addressed in the DOH guidance document (Section 3.4.2).
Consistent with EPA vapor guidance	Concern that the procedures outlined in the strategy complement and not contradict the well-established EPA soil vapor intrusion guidance procedures.	Approaches to completing soil vapor intrusion evaluations are discussed in the companion DOH guidance document and are beyond the scope of this policy. However, neither the strategy for prioritizing legacy sites nor the proposed soil vapor intrusion guidance document contradicts the intent of the EPA guidance.

**Program Policy DER-13: Strategy for Prioritizing Soil Vapor Intrusion Evaluations at Remedial Sites in New York
Summary of Review and Resolution of Major Issues and Comments**

Issue	Summary of Comment	Resolution
Cost-benefit	Comments centering on the economic impacts of implementing this policy and concerns that resources will be spent unnecessarily with little benefit.	The Department believes that there may be sites that were previously remediated which still pose unacceptable soil vapor intrusion exposure. Since there may be sites with unacceptable exposures we believe that the benefit of reducing these unacceptable exposures will outweigh the cost of investigation past sites.
Exit strategy/no exposures	Concern that sites with little or no reasonable risk will be required to “prove a negative” and be retained on the vapor list indefinitely. The policy should clarify what criteria will be used to identify sites that do not pose a reasonable risk of soil vapor intrusion and should be removed from further consideration.	The strategy does not specify how the soil vapor intrusion evaluations will be conducted (or completed). Sites that were included on the list have the potential for exposures related to soil vapor intrusion. This potential may not have been evaluated during investigation of the nature and extent of contamination of the site. Data are required to resolve the question. Data may already exist (from site investigation, remedial action, or operation, maintenance and monitoring) to resolve it. Whenever, based on the review of existing (or new) data, a determination is made that a particular site does not present an unacceptable soil vapor intrusion exposure, the evaluation will be considered complete.
Future exposure	If development or occupation of an existing building could result in conditions that favor soil vapor intrusion in the future, will institutional controls be established?	The strategy does not specify how the soil vapor intrusion evaluations will be conducted. Data evaluation and recommended actions are discussed in Chapter 3 of the DOH guidance document.
General/applicability	General comments on the applicability of the policy and requests for minor edits and clarification of terms.	Incorporated as appropriate

**Program Policy DER-13: Strategy for Prioritizing Soil Vapor Intrusion Evaluations at Remedial Sites in New York
Summary of Review and Resolution of Major Issues and Comments**

Issue	Summary of Comment	Resolution
Investigation scope	Technical questions pertaining to the details of a site-specific investigation.	The intent of the policy is to state that the potential for soil vapor intrusion will be evaluated at all sites and to describe the process used by the Department to select and to prioritize past sites for soil vapor intrusion evaluations. The companion DOH guidance document (Section 2) provides recommendations on how these evaluations are to be conducted.
Legal authority	Questioned the State’s authority to require sampling at sites that have been delisted or closed without demonstrating that a potential significant threat exists.	The Department has the authority and responsibility to require these evaluations. ECL 1-0101, 3-0301.1(I), 27-1305.2(a) and 27-1309. The Department is also authorized to recover the cost of such sampling and analysis from any responsible person. (see e.g. ECL 27-1309.5). The Commissioner, after investigation, providing notice and the respondent an opportunity to be heard, may also issue, modify and revoke orders as may be necessary or appropriate. ECL 71-2727.
Odor threshold	Questioned the technical basis for stating that the odor threshold of non-chlorinated hydrocarbons was lower than levels that would cause health impacts.	Non chlorinated hydrocarbons (petroleum) generally have odor thresholds that are very low . Our experience has been that the levels which could be detected by smell did not always present an unacceptable exposure. The vapor intrusion potential of these sites will be evaluated but only after the sites with chlorinated VOCs are evaluated first.
Preferential flow	Questioned the validity of increasing the weighting factor based on the presence of a preferential pathway for vapor migration.	Preferential pathways have the potential to facillitate vapor transport. If a preferential pathway is known, the weighting was increased. The actual impact of any preferential pathways cannot be predetermined and will be evaluated in more detail during the investigation phase.

**Program Policy DER-13: Strategy for Prioritizing Soil Vapor Intrusion Evaluations at Remedial Sites in New York
Summary of Review and Resolution of Major Issues and Comments**

Issue	Summary of Comment	Resolution
Ranking/scoring	The policy lacks necessary information explaining how and why the ranking system was developed, making it difficult to evaluate the appropriateness of such screening and ranking procedures and apply the criteria consistently.	The ranking system was developed to prioritize and to provide some separation between the different sites in order to manage the use of resources. Specific criteria were based on factors that are thought to have the most impact on the potential for soil vapor intrusion. The actual ranking of the sites was done based on data from the decision documents as well as other factors known specifically about the site. However, the ranking system has less relevance because all sites on the list will be evaluated for soil vapor intrusion potential. The evaluation will be conducted by either EPA, the Responsible Party (under the oversight of DEC) or in cases where a Responsible Party does not exist or is unwilling, by DEC. The ranking system will be used to prioritize the sites where DEC will lead the evaluation to ensure that sites with the highest potential for vapor intrusion are evaluated first.
Schedule	Questioned how many sites will be investigated and when will the investigations be completed.	The Agencies goal is to evaluate all of the past sites for soil vapor intrusion at all sites as quickly as possible. It is not possible to set a time frame for completion of the evaluation of all past sites.
Updates/revisions	Request for the opportunity to provide input on the ranking and prioritization of individual sites and to comment on future revisions.	The ranking process has been completed. As explained above, the ranking system is somewhat irrelevant now because all sites will be evaluated. Site owners will be informed of the Department's interest in evaluating their site for soil vapor intrusion and will be given the opportunity to provide updated information. Adjacent residents will have opportunities to participate in the investigative process via Citizen Participation activities.

**Program Policy DER-13: Strategy for Prioritizing Soil Vapor Intrusion Evaluations at Remedial Sites in New York
Summary of Review and Resolution of Major Issues and Comments**

Issue	Summary of Comment	Resolution
Who will conduct/pay?	Questioned who will be required to pay for the initial vapor investigation at sites where there is no clear threat. Request that the initial rounds of sampling be completed using State funds.	The USEPA has agreed to be the lead at all former and current sites on the National Priorities List (NPL) that are located in New York State. For the remaining sites, the Department will ask the party responsible for contaminating the site to pay for and perform the soil vapor intrusion evaluation, as well as any site investigations and remedial action required. If the responsible party declines to perform these activities, or if no viable entity exists, the State will proceed with the evaluation and seek to recover the costs incurred as part of that evaluation, and any necessary remediation.

LABELLA
LaBella Associates, P.C.

300 State Street
Rochester, New York 14614

Appendix 4



OSWER Draft Guidance for Evaluating the Vapor Intrusion to Indoor Air Pathway from Groundwater and Soils (Subsurface Vapor Intrusion Guidance)

November 2002

EPA530-D-02-004

Table 1: Question 1 Summary Sheet.

CAS No.	Chemical	Is Chemical Sufficiently Toxic? ¹	Is Chemical Sufficiently Volatile? ²	Check Here if Known or Reasonably Suspected To Be Present ³
83329	Acenaphthene	YES	YES	
75070	Acetaldehyde	YES	YES	
67641	Acetone	YES	YES	
75058	Acetonitrile	YES	YES	
98862	Acetophenone	YES	YES	
107028	Acrolein	YES	YES	
107131	Acrylonitrile	YES	YES	
309002	Aldrin	YES	YES	
319846	alpha-HCH (alpha-BHC)	YES	YES	
62533	Aniline	YES	NO	NA
120127	Anthracene	NO	YES	NA
56553	Benzo(a)anthracene	YES	NO	NA
100527	Benzaldehyde	YES	YES	
71432	Benzene	YES	YES	
50328	Benzo(a)pyrene	YES	NO	NA
205992	Benzo(b)fluoranthene	YES	YES	
207089	Benzo(k)fluoranthene	NO	NO	NA
65850	Benzoic Acid	NO	NO	NA
100516	Benzyl alcohol	YES	NO	NA
100447	Benzylchloride	YES	YES	
91587	beta-Chloronaphthalene	YES	YES	
319857	beta-HCH (beta-BHC)	YES	NO	NA
92524	Biphenyl	YES	YES	
111444	Bis(2-chloroethyl)ether	YES	YES	
108601	Bis(2-chloroisopropyl)ether	YES	YES	
117817	Bis(2-ethylhexyl)phthalate	NO	NO	NA
542881	Bis(chloromethyl)ether	YES	YES	
75274	Bromodichloromethane	YES	YES	
75252	Bromoform	YES	YES	
106990	1,3-Butadiene	YES	YES	
71363	Butanol	YES	NO	NA
85687	Butyl benzyl phthalate	NO	NO	NA
86748	Carbazole	YES	NO	NA
75150	Carbon disulfide	YES	YES	
56235	Carbon tetrachloride	YES	YES	
57749	Chlordane	YES	YES	
126998	2-Chloro-1,3-butadiene (chloroprene)	YES	YES	
108907	Chlorobenzene	YES	YES	
109693	1-Chlorobutane	YES	YES	
124481	Chlorodibromomethane	YES	YES	
75456	Chlorodifluoromethane	YES	YES	
75003	Chloroethane (ethyl chloride)	YES	YES	
67663	Chloroform	YES	YES	
95578	2-Chlorophenol	YES	YES	
75296	2-Chloropropane	YES	YES	
218019	Chrysene	YES	YES	
156592	cis-1,2-Dichloroethylene	YES	YES	
123739	Crotonaldehyde (2-butenal)	YES	YES	
98828	Cumene	YES	YES	
72548	DDD	YES	NO	NA
72559	DDE	YES	YES	
50293	DDT	YES	NO	NA
53703	Dibenz(a,h)anthracene	YES	NO	NA
132649	Dibenzofuran	YES	YES	
96128	1,2-Dibromo-3-chloropropane	YES	YES	
106934	1,2-Dibromoethane (ethylene dibromide)	YES	YES	
541731	1,3-Dichlorobenzene	YES	YES	
95501	1,2-Dichlorobenzene	YES	YES	
106467	1,4-Dichlorobenzene	YES	YES	
91941	3,3-Dichlorobenzidine	YES	NO	NA
75718	Dichlorodifluoromethane	YES	YES	

Table 1: Question 1 Summary Sheet.

CAS No.	Chemical	Is Chemical Sufficiently Toxic? ¹	Is Chemical Sufficiently Volatile? ²	Check Here if Known or Reasonably Suspected To Be Present ³
75343	1,1-Dichloroethane	YES	YES	
107062	1,2-Dichloroethane	YES	YES	
75354	1,1-Dichloroethylene	YES	YES	
120832	2,4-Dichlorophenol	YES	NO	NA
78875	1,2-Dichloropropane	YES	YES	
542756	1,3-Dichloropropene	YES	YES	
60571	Dieldrin	YES	YES	
84662	Diethylphthalate	YES	NO	NA
105679	2,4-Dimethylphenol	YES	NO	NA
131113	Dimethylphthalate	NA	NO	NA
84742	Di-n-butyl phthalate	NO	NO	NA
534521	4,6-Dinitro-2-methylphenol (4,6-dinitro-o-cresol)	YES	NO	NA
51285	2,4-Dinitrophenol	YES	NO	NA
121142	2,4-Dinitrotoluene	YES	NO	NA
606202	2,6-Dinitrotoluene	YES	NO	NA
117840	Di-n-octyl phthalate	NO	YES	NA
115297	Endosulfan	YES	YES	
72208	Endrin	YES	NO	NA
106898	Epichlorohydrin	YES	YES	
60297	Ethyl ether	YES	YES	
141786	Ethylacetate	YES	YES	
100414	Ethylbenzene	YES	YES	
75218	Ethylene oxide	YES	YES	
97632	Ethylmethacrylate	YES	YES	
206440	Fluoranthene	NO	YES	NA
86737	Fluorene	YES	YES	
110009	Furan	YES	YES	
58899	gamma-HCH (Lindane)	YES	YES	
76448	Heptachlor	YES	YES	
1024573	Heptachlor epoxide	YES	NO	NA
87683	Hexachloro-1,3-butadiene	YES	YES	
118741	Hexachlorobenzene	YES	YES	
77474	Hexachlorocyclopentadiene	YES	YES	
67721	Hexachloroethane	YES	YES	
110543	Hexane	YES	YES	
74908	Hydrogen cyanide	YES	YES	
193395	Indeno(1,2,3-cd)pyrene	NO	NO	NA
78831	Isobutanol	YES	YES	
78591	Isophorone	YES	NO	NA
7439976	Mercury (elemental)	YES	YES	
126987	Methacrylonitrile	YES	YES	
72435	Methoxychlor	YES	YES	
79209	Methyl acetate	YES	YES	
96333	Methyl acrylate	YES	YES	
74839	Methyl bromide	YES	YES	
74873	Methyl chloride (chloromethane)	YES	YES	
108872	Methylcyclohexane	YES	YES	
74953	Methylene bromide	YES	YES	
75092	Methylene chloride	YES	YES	
78933	Methylethylketone (2-butanone)	YES	YES	
108101	Methylisobutylketone	YES	YES	
80626	Methylmethacrylate	YES	YES	
91576	2-Methylnaphthalene	YES	YES	
108394	3-Methylphenol (m-cresol)	YES	NO	NA
95487	2-Methylphenol (o-cresol)	YES	NO	NA
106455	4-Methylphenol (p-cresol)	YES	NO	NA
99081	m-Nitrotoluene	YES	NO	NA
1634044	MTBE	YES	YES	
108383	m-Xylene	YES	YES	
91203	Naphthalene	YES	YES	
104518	n-Butylbenzene	YES	YES	

Table 1: Question 1 Summary Sheet.

CAS No.	Chemical	Is Chemical Sufficiently Toxic? ¹	Is Chemical Sufficiently Volatile? ²	Check Here if Known or Reasonably Suspected To Be Present ³
98953	Nitrobenzene	YES	YES	
100027	4-Nitrophenol	YES	NO	NA
79469	2-Nitropropane	YES	YES	
924163	N-Nitroso-di-n-butylamine	YES	YES	
621647	N-Nitrosodi-n-propylamine	YES	NO	NA
86306	N-Nitrosodiphenylamine	YES	NO	NA
103651	n-Propylbenzene	YES	YES	
88722	o-Nitrotoluene	YES	YES	
95476	o-Xylene	YES	YES	
106478	p-Chloroaniline	YES	NO	NA
87865	Pentachlorophenol	YES	NO	NA
108952	Phenol	YES	NO	NA
99990	p-Nitrotoluene	YES	NO	NA
106423	p-Xylene	YES	YES	
129000	Pyrene	YES	YES	
110861	Pyridine	YES	NO	NA
135988	sec-Butylbenzene	YES	YES	
100425	Styrene	YES	YES	
98066	tert-Butylbenzene	YES	YES	
630206	1,1,1,2-Tetrachloroethane	YES	YES	
79345	1,1,2,2-Tetrachloroethane	YES	YES	
127184	Tetrachloroethylene	YES	YES	
108883	Toluene	YES	YES	
8001352	Toxaphene	YES	NO	NA
156605	trans-1,2-Dichloroethylene	YES	YES	
76131	1,1,2-Trichloro-1,2,2-trifluoroethane	YES	YES	
120821	1,2,4-Trichlorobenzene	YES	YES	
79005	1,1,2-Trichloroethane	YES	YES	
71556	1,1,1-Trichloroethane	YES	YES	
79016	Trichloroethylene	YES	YES	
75694	Trichlorofluoromethane	YES	YES	
95954	2,4,5-Trichlorophenol	YES	NO	NA
88062	2,4,6-Trichlorophenol	YES	NO	NA
96184	1,2,3-Trichloropropane	YES	YES	
95636	1,2,4-Trimethylbenzene	YES	YES	
108678	1,3,5-Trimethylbenzene	YES	YES	
108054	Vinyl acetate	YES	YES	
75014	Vinyl chloride (chloroethene)	YES	YES	

¹ A chemical is considered sufficiently toxic if the vapor concentration of the pure component (see Appendix D) poses an incremental lifetime cancer risk greater than 10^{-6} or a non-cancer hazard index greater than 1.

² A chemical is considered sufficiently volatile if its Henry's Law Constant is 1×10^{-5} atm-m³/mol or greater (US EPA, 1991).

³ Users should check off compounds that meet the criteria for toxicity and volatility and are known or reasonably suspected to be present.

Table 2a: Question 4 Generic Screening Levels and Summary Sheet ¹

Risk = 1 x 10⁻⁴

CAS No.	Chemical	Compounds with Provisional Toxicity Data Extrapolated From Oral Sources	Basis of Target Concentration C=cancer risk NC=noncancer risk	Target Indoor Air Concentration to Satisfy Both the Prescribed Risk Level and the Target Hazard Index [R=10 ⁻⁴ , HI=1) C _{target}		Measured or Reasonably Estimated Indoor Air Concentration [if available] (specify units)	Target Shallow Soil Gas Concentration Corresponding to Target Indoor Air Concentration Where the Soil Gas to Indoor Air Attenuation Factor=0.1 C _{soil-gas}		Measured or Reasonably Estimated Shallow Soil Gas Concentration [if available] (specify units)	Target Deep Soil Gas Concentration Corresponding to Target Indoor Air Concentration Where the Soil Gas to Indoor Air Attenuation Factor=0.01 C _{soil-gas}		Measured or Reasonably Estimated Deep Soil Gas Concentration [if available] (specify units)	Target Groundwater Concentration Corresponding to Target Indoor Air Concentration Where the Soil Gas to Indoor Air Attenuation Factor = 0.001 and Partitioning Across the Water Table Obeys Henry's Law C _{gw}	Measured or Reasonably Estimated Groundwater Concentration [if available] (specify units)
				(ug/m ³)	(ppbv)		(ug/m ³)	(ppbv)		(ug/m ³)	(ppbv)			
83329	Acenaphthene	X	NC	2.1E+02	3.3E+01		2.1E+03	3.3E+02		2.1E+04	3.3E+03		**	
75070	Acetaldehyde		NC	9.0E+00	5.0E+00		9.0E+01	5.0E+01		9.0E+02	5.0E+02		2.8E+03	
67641	Acetone	X	NC	3.5E+02	1.5E+02		3.5E+03	1.5E+03		3.5E+04	1.5E+04		2.2E+05	
75058	Acetonitrile		NC	6.0E+01	3.6E+01		6.0E+02	3.6E+02		6.0E+03	3.6E+03		4.2E+04	
98862	Acetophenone	X	NC	3.5E+02	7.1E+01		3.5E+03	7.1E+02		3.5E+04	7.1E+03		8.0E+05	
107028	Acrolein		NC	2.0E-02	8.7E-03		2.0E-01	8.7E-02		2.0E+00	8.7E-01		4.0E+00	
107131	Acrylonitrile		NC	2.0E+00	9.2E-01		2.0E+01	9.2E+00		2.0E+02	9.2E+01		4.7E+02	
309002	Aldrin		C	5.0E-02	3.3E-03		5.0E-01	3.3E-02		5.0E+00	3.3E-01		7.1E+00	
319846	alpha-HCH (alpha-BHC)		C	1.4E-01	1.1E-02		1.4E+00	1.1E-01		1.4E+01	1.1E+00		3.1E+02	
100527	Benzaldehyde	X	NC	3.5E+02	8.1E+01		3.5E+03	8.1E+02		3.5E+04	8.1E+03		3.6E+05	
71432	Benzene		C	3.1E+01	9.8E+00		3.1E+02	9.8E+01		3.1E+03	9.8E+02		1.4E+02	
205992	Benzo(b)fluoranthene	X	C	1.2E+00	1.1E-01		**	**		**	**		**	
100447	Benzylchloride	X	C	5.0E+00	9.7E-01		5.0E+01	9.7E+00		5.0E+02	9.7E+01		3.0E+02	
91587	beta-Chloronaphthalene	X	NC	2.8E+02	4.2E+01		2.8E+03	4.2E+02		2.8E+04	4.2E+03		**	
92524	Biphenyl	X	NC	1.8E+02	2.8E+01		1.8E+03	2.8E+02		1.8E+04	2.8E+03		**	
111444	Bis(2-chloroethyl)ether		C	7.4E-01	1.3E-01		7.4E+00	1.3E+00		7.4E+01	1.3E+01		1.0E+03	
108601	Bis(2-chloroisopropyl)ether		C	2.4E+01	3.5E+00		2.4E+02	3.5E+01		2.4E+03	3.5E+02		5.1E+03	
542881	Bis(chloromethyl)ether		C	3.9E-03	8.4E-04		3.9E-02	8.4E-03		3.9E-01	8.4E-02		4.5E-01	
75274	Bromodichloromethane	X	C	1.4E+01	2.1E+00		1.4E+02	2.1E+01		1.4E+03	2.1E+02		2.1E+02	
75252	Bromoform		C	2.2E+02	2.1E+01		2.2E+03	2.1E+02		2.2E+04	2.1E+03		8.3E-01	
106990	1,3-Butadiene		C	8.7E-01	3.9E-01		8.7E+00	3.9E+00		8.7E+01	3.9E+01		2.9E-01	
75150	Carbon disulfide		NC	7.0E+02	2.2E+02		7.0E+03	2.2E+03		7.0E+04	2.2E+04		5.6E+02	
56235	Carbon tetrachloride		C	1.6E+01	2.6E+00		1.6E+02	2.6E+01		1.6E+03	2.6E+02		1.3E+01	
57749	Chlordane		NC	7.0E-01	4.2E-02		7.0E+00	4.2E-01		7.0E+01	4.2E+00		**	
126998	2-Chloro-1,3-butadiene (chloroprene)		NC	7.0E+00	1.9E+00		7.0E+01	1.9E+01		7.0E+02	1.9E+02		1.4E+01	
108907	Chlorobenzene		NC	6.0E+01	1.3E+01		6.0E+02	1.3E+02		6.0E+03	1.3E+03		3.9E+02	
109693	1-Chlorobutane	X	NC	1.4E+03	3.7E+02		1.4E+04	3.7E+03		1.4E+05	3.7E+04		2.0E+03	
124481	Chlorodibromomethane	X	C	1.0E+01	1.2E+00		1.0E+02	1.2E+01		1.0E+03	1.2E+02		3.2E+02	
75456	Chlorodifluoromethane		NC	5.0E+04	1.4E+04		5.0E+05	1.4E+05		**	**		**	
75003	Chloroethane (ethyl chloride)		NC	1.0E+04	3.8E+03		1.0E+05	3.8E+04		1.0E+06	3.8E+05		2.8E+04	
67663	Chloroform		C	1.1E+01	2.2E+00		1.1E+02	2.2E+01		1.1E+03	2.2E+02		8.0E+01 [†]	
95578	2-Chlorophenol	X	NC	1.8E+01	3.3E+00		1.8E+02	3.3E+01		1.8E+03	3.3E+02		1.1E+03	
75296	2-Chloropropane		NC	1.0E+02	3.2E+01		1.0E+03	3.2E+02		1.0E+04	3.2E+03		1.7E+02	
218019	Chrysene	X	*	*	*		*	*		*	*		*	
156592	cis-1,2-Dichloroethylene	X	NC	3.5E+01	8.8E+00		3.5E+02	8.8E+01		3.5E+03	8.8E+02		2.1E+02	
123739	Crotonaldehyde (2-butenal)	X	C	4.5E-01	1.6E-01		4.5E+00	1.6E+00		4.5E+01	1.6E+01		5.6E+02	
98828	Cumene		NC	4.0E+02	8.1E+01		4.0E+03	8.1E+02		4.0E+04	8.1E+03		8.4E+00	

Table 2a: Question 4 Generic Screening Levels and Summary Sheet ¹

Risk = 1 x 10⁻⁴

CAS No.	Chemical	Compounds with Provisional Toxicity Data Extrapolated From Oral Sources	Basis of Target Concentration C=cancer risk NC=noncancer risk	Target Indoor Air Concentration to Satisfy Both the Prescribed Risk Level and the Target Hazard Index [R=10 ⁻⁴ , HI=1) C _{target}		Measured or Reasonably Estimated Indoor Air Concentration [if available] (specify units)	Target Shallow Soil Gas Concentration Corresponding to Target Indoor Air Concentration Where the Soil Gas to Indoor Air Attenuation Factor=0.1 C _{soil-gas}		Measured or Reasonably Estimated Shallow Soil Gas Concentration [if available] (specify units)	Target Deep Soil Gas Concentration Corresponding to Target Indoor Air Concentration Where the Soil Gas to Indoor Air Attenuation Factor=0.01 C _{soil-gas}		Measured or Reasonably Estimated Deep Soil Gas Concentration [if available] (specify units)	Target Groundwater Concentration Corresponding to Target Indoor Air Concentration Where the Soil Gas to Indoor Air Attenuation Factor = 0.001 and Partitioning Across the Water Table Obeys Henry's Law C _{gw}	Measured or Reasonably Estimated Groundwater Concentration [if available] (specify units)
				(ug/m ³)	(ppbv)		(ug/m ³)	(ppbv)		(ug/m ³)	(ppbv)			
72559	DDE	X	C	2.5E+00	1.9E-01		2.5E+01	1.9E+00		**	**		**	
132649	Dibenzofuran	X	NC	1.4E+01	2.0E+00		1.4E+02	2.0E+01		1.4E+03	2.0E+02		**	
96128	1,2-Dibromo-3-chloropropane		NC	2.0E-01	2.1E-02		2.0E+00	2.1E-01		2.0E+01	2.1E+00		3.3E+01	
106934	1,2-Dibromoethane (ethylene dibromide)		NC	2.0E-01	2.6E-02		2.0E+00	2.6E-01		2.0E+01	2.6E+00		6.6E+00	
541731	1,3-Dichlorobenzene	X	NC	1.1E+02	1.7E+01		1.1E+03	1.7E+02		1.1E+04	1.7E+03		8.3E+02	
95501	1,2-Dichlorobenzene		NC	2.0E+02	3.3E+01		2.0E+03	3.3E+02		2.0E+04	3.3E+03		2.6E+03	
106467	1,4-Dichlorobenzene		NC	8.0E+02	1.3E+02		8.0E+03	1.3E+03		8.0E+04	1.3E+04		8.2E+03	
75718	Dichlorodifluoromethane		NC	2.0E+02	4.0E+01		2.0E+03	4.0E+02		2.0E+04	4.0E+03		1.4E+01	
75343	1,1-Dichloroethane		NC	5.0E+02	1.2E+02		5.0E+03	1.2E+03		5.0E+04	1.2E+04		2.2E+03	
107062	1,2-Dichloroethane		C	9.4E+00	2.3E+00		9.4E+01	2.3E+01		9.4E+02	2.3E+02		2.3E+02	
75354	1,1-Dichloroethylene		NC	2.0E+02	5.0E+01		2.0E+03	5.0E+02		2.0E+04	5.0E+03		1.9E+02	
78875	1,2-Dichloropropane		NC	4.0E+00	8.7E-01		4.0E+01	8.7E+00		4.0E+02	8.7E+01		3.5E+01	
542756	1,3-Dichloropropene		NC	2.0E+01	4.4E+00		2.0E+02	4.4E+01		2.0E+03	4.4E+02		2.8E+01	
60571	Dieldrin		C	5.3E-02	3.4E-03		5.3E-01	3.4E-02		5.3E+00	3.4E-01		8.6E+01	
115297	Endosulfan	X	NC	2.1E+01	1.3E+00		2.1E+02	1.3E+01		**	**		**	
106898	Epichlorohydrin		NC	1.0E+00	2.6E-01		1.0E+01	2.6E+00		1.0E+02	2.6E+01		8.0E+02	
60297	Ethyl ether	X	NC	7.0E+02	2.3E+02		7.0E+03	2.3E+03		7.0E+04	2.3E+04		5.2E+02	
141786	Ethylacetate	X	NC	3.2E+03	8.7E+02		3.2E+04	8.7E+03		3.2E+05	8.7E+04		5.6E+05	
100414	Ethylbenzene		C	2.2E+02	5.1E+01		2.2E+03	5.1E+02		2.2E+04	5.1E+03		7.0E+02 †	
75218	Ethylene oxide		C	2.4E+00	1.4E+00		2.4E+01	1.4E+01		2.4E+02	1.4E+02		1.1E+02	
97632	Ethylmethacrylate	X	NC	3.2E+02	6.8E+01		3.2E+03	6.8E+02		3.2E+04	6.8E+03		9.1E+03	
86737	Fluorene	X	NC	1.4E+02	2.1E+01		1.4E+03	2.1E+02		**	**		**	
110009	Furan	X	NC	3.5E+00	1.3E+00		3.5E+01	1.3E+01		3.5E+02	1.3E+02		1.6E+01	
58899	gamma-HCH (Lindane)	X	C	6.6E-01	5.5E-02		6.6E+00	5.5E-01		6.6E+01	5.5E+00		1.1E+03	
76448	Heptachlor		C	1.9E-01	1.2E-02		1.9E+00	1.2E-01		1.9E+01	1.2E+00		4.0E-01 †	
87683	Hexachloro-1,3-butadiene		C	1.1E+01	1.0E+00		1.1E+02	1.0E+01		1.1E+03	1.0E+02		3.3E+01	
118741	Hexachlorobenzene		C	5.3E-01	4.5E-02		5.3E+00	4.5E-01		5.3E+01	4.5E+00		**	
77474	Hexachlorocyclopentadiene		NC	2.0E-01	1.8E-02		2.0E+00	1.8E-01		2.0E+01	1.8E+00		5.0E+01 †	
67721	Hexachloroethane		C	6.1E+01	6.3E+00		6.1E+02	6.3E+01		6.1E+03	6.3E+02		3.8E+02	
110543	Hexane		NC	2.0E+02	5.7E+01		2.0E+03	5.7E+02		2.0E+04	5.7E+03		2.9E+00	
74908	Hydrogen cyanide		NC	3.0E+00	2.7E+00		3.0E+01	2.7E+01		3.0E+02	2.7E+02		5.5E+02	
78831	Isobutanol	X	NC	1.1E+03	3.5E+02		1.1E+04	3.5E+03		1.1E+05	3.5E+04		2.2E+06	
7439976	Mercury (elemental)		NC	3.0E-01	3.7E-02		3.0E+00	3.7E-01		3.0E+01	3.7E+00		6.8E-01	
126987	Methacrylonitrile		NC	7.0E-01	2.6E-01		7.0E+00	2.6E+00		7.0E+01	2.6E+01		6.9E+01	
72435	Methoxychlor	X	NC	1.8E+01	1.2E+00		**	**		**	**		**	
79209	Methyl acetate	X	NC	3.5E+03	1.2E+03		3.5E+04	1.2E+04		3.5E+05	1.2E+05		7.2E+05	
96333	Methyl acrylate	X	NC	1.1E+02	3.0E+01		1.1E+03	3.0E+02		1.1E+04	3.0E+03		1.4E+04	

Table 2a: Question 4 Generic Screening Levels and Summary Sheet ¹

Risk = 1 x 10⁻⁴

CAS No.	Chemical	Compounds with Provisional Toxicity Data Extrapolated From Oral Sources	Basis of Target Concentration C=cancer risk NC=noncancer risk	Target Indoor Air Concentration to Satisfy Both the Prescribed Risk Level and the Target Hazard Index [R=10 ⁻⁴ , HI=1) C _{target}		Measured or Reasonably Estimated Indoor Air Concentration [if available] (specify units)	Target Shallow Soil Gas Concentration Corresponding to Target Indoor Air Concentration Where the Soil Gas to Indoor Air Attenuation Factor=0.1 C _{soil-gas}		Measured or Reasonably Estimated Shallow Soil Gas Concentration [if available] (specify units)	Target Deep Soil Gas Concentration Corresponding to Target Indoor Air Concentration Where the Soil Gas to Indoor Air Attenuation Factor=0.01 C _{soil-gas}		Measured or Reasonably Estimated Deep Soil Gas Concentration [if available] (specify units)	Target Groundwater Concentration Corresponding to Target Indoor Air Concentration Where the Soil Gas to Indoor Air Attenuation Factor = 0.001 and Partitioning Across the Water Table Obeys Henry's Law C _{gw}	Measured or Reasonably Estimated Groundwater Concentration [if available] (specify units)
				(ug/m ³)	(ppbv)		(ug/m ³)	(ppbv)		(ug/m ³)	(ppbv)			
74839	Methyl bromide		NC	5.0E+00	1.3E+00		5.0E+01	1.3E+01		5.0E+02	1.3E+02		2.0E+01	
74873	Methyl chloride (chloromethane)		NC	9.0E+01	4.4E+01		9.0E+02	4.4E+02		9.0E+03	4.4E+03		2.5E+02	
108872	Methylcyclohexane		NC	3.0E+03	7.5E+02		3.0E+04	7.5E+03		3.0E+05	7.5E+04		7.1E+02	
74953	Methylene bromide	X	NC	3.5E+01	4.9E+00		3.5E+02	4.9E+01		3.5E+03	4.9E+02		9.9E+02	
75092	Methylene chloride		C	5.2E+02	1.5E+02		5.2E+03	1.5E+03		5.2E+04	1.5E+04		5.8E+03	
78933	Methylethylketone (2-butanone)		NC	1.0E+03	3.4E+02		1.0E+04	3.4E+03		1.0E+05	3.4E+04		4.4E+05	
108101	Methylisobutylketone		NC	8.0E+01	2.0E+01		8.0E+02	2.0E+02		8.0E+03	2.0E+03		1.4E+04	
80626	Methylmethacrylate		NC	7.0E+02	1.7E+02		7.0E+03	1.7E+03		7.0E+04	1.7E+04		5.1E+04	
91576	2-Methylnaphthalene	X	NC	7.0E+01	1.2E+01		7.0E+02	1.2E+02		7.0E+03	1.2E+03		3.3E+03	
1634044	MTBE		NC	3.0E+03	8.3E+02		3.0E+04	8.3E+03		3.0E+05	8.3E+04		1.2E+05	
108383	m-Xylene	X	NC	7.0E+03	1.6E+03		7.0E+04	1.6E+04		7.0E+05	1.6E+05		2.3E+04	
91203	Naphthalene		NC	3.0E+00	5.7E-01		3.0E+01	5.7E+00		3.0E+02	5.7E+01		1.5E+02	
104518	n-Butylbenzene	X	NC	1.4E+02	2.6E+01		1.4E+03	2.6E+02		1.4E+04	2.6E+03		2.6E+02	
98953	Nitrobenzene		NC	2.0E+00	4.0E-01		2.0E+01	4.0E+00		2.0E+02	4.0E+01		2.0E+03	
79469	2-Nitropropane		C	9.0E-02	2.5E-02		9.0E-01	2.5E-01		9.0E+00	2.5E+00		1.8E+01	
924163	N-Nitroso-di-n-butylamine		C	1.5E-01	2.4E-02		1.5E+00	2.4E-01		1.5E+01	2.4E+00		1.2E+01	
103651	n-Propylbenzene	X	NC	1.4E+02	2.8E+01		1.4E+03	2.8E+02		1.4E+04	2.8E+03		3.2E+02	
88722	o-Nitrotoluene	X	NC	3.5E+01	6.2E+00		3.5E+02	6.2E+01		3.5E+03	6.2E+02		6.8E+04	
95476	o-Xylene	X	NC	7.0E+03	1.6E+03		7.0E+04	1.6E+04		7.0E+05	1.6E+05		3.3E+04	
106423	p-Xylene	X	NC	7.0E+03	1.6E+03		7.0E+04	1.6E+04		7.0E+05	1.6E+05		2.2E+04	
129000	Pyrene	X	NC	1.1E+02	1.3E+01		**	**		**	**		**	
135988	sec-Butylbenzene	X	NC	1.4E+02	2.6E+01		1.4E+03	2.6E+02		1.4E+04	2.6E+03		2.5E+02	
100425	Styrene		NC	1.0E+03	2.3E+02		1.0E+04	2.3E+03		1.0E+05	2.3E+04		8.9E+03	
98066	tert-Butylbenzene	X	NC	1.4E+02	2.6E+01		1.4E+03	2.6E+02		1.4E+04	2.6E+03		2.9E+02	
630206	1,1,1,2-Tetrachloroethane		C	3.3E+01	4.8E+00		3.3E+02	4.8E+01		3.3E+03	4.8E+02		3.3E+02	
79345	1,1,2,2-Tetrachloroethane		C	4.2E+00	6.1E-01		4.2E+01	6.1E+00		4.2E+02	6.1E+01		3.0E+02	
127184	Tetrachloroethylene		C	8.1E+01	1.2E+01		8.1E+02	1.2E+02		8.1E+03	1.2E+03		1.1E+02	
108883	Toluene		NC	4.0E+02	1.1E+02		4.0E+03	1.1E+03		4.0E+04	1.1E+04		1.5E+03	
156605	trans-1,2-Dichloroethylene	X	NC	7.0E+01	1.8E+01		7.0E+02	1.8E+02		7.0E+03	1.8E+03		1.8E+02	
76131	1,1,2-Trichloro-1,2,2-trifluoroethane		NC	3.0E+04	3.9E+03		3.0E+05	3.9E+04		3.0E+06	3.9E+05		1.5E+03	
120821	1,2,4-Trichlorobenzene		NC	2.0E+02	2.7E+01		2.0E+03	2.7E+02		2.0E+04	2.7E+03		3.4E+03	
79005	1,1,2-Trichloroethane		C	1.5E+01	2.8E+00		1.5E+02	2.8E+01		1.5E+03	2.8E+02		4.1E+02	
71556	1,1,1-Trichloroethane		NC	2.2E+03	4.0E+02		2.2E+04	4.0E+03		2.2E+05	4.0E+04		3.1E+03	
79016	Trichloroethylene ^{††}	X	C	2.2E+00	4.1E-01		2.2E+01	4.1E+00		2.2E+02	4.1E+01		5.3E+00	
75694	Trichlorofluoromethane		NC	7.0E+02	1.2E+02		7.0E+03	1.2E+03		7.0E+04	1.2E+04		1.8E+02	
96184	1,2,3-Trichloropropane		NC	4.9E+00	8.1E-01		4.9E+01	8.1E+00		4.9E+02	8.1E+01		2.9E+02	
95636	1,2,4-Trimethylbenzene		NC	6.0E+00	1.2E+00		6.0E+01	1.2E+01		6.0E+02	1.2E+02		2.4E+01	

Table 2a: Question 4 Generic Screening Levels and Summary Sheet ¹

Risk = 1 x 10⁻⁴

CAS No.	Chemical	Compounds with Provisional Toxicity Data Extrapolated From Oral Sources	Basis of Target Concentration C=cancer risk NC=noncancer risk	Target Indoor Air Concentration to Satisfy Both the Prescribed Risk Level and the Target Hazard Index [R=10 ⁻⁴ , HI=1) C _{target}		Measured or Reasonably Estimated Indoor Air Concentration [if available] (specify units)	Target Shallow Soil Gas Concentration Corresponding to Target Indoor Air Concentration Where the Soil Gas to Indoor Air Attenuation Factor=0.1 C _{soil-gas}		Measured or Reasonably Estimated Shallow Soil Gas Concentration [if available] (specify units)	Target Deep Soil Gas Concentration Corresponding to Target Indoor Air Concentration Where the Soil Gas to Indoor Air Attenuation Factor=0.01 C _{soil-gas}		Measured or Reasonably Estimated Deep Soil Gas Concentration [if available] (specify units)	Target Groundwater Concentration Corresponding to Target Indoor Air Concentration Where the Soil Gas to Indoor Air Attenuation Factor = 0.001 and Partitioning Across the Water Table Obeys Henry's Law C _{gw}	Measured or Reasonably Estimated Groundwater Concentration [if available] (specify units)
				(ug/m ³)	(ppbv)		(ug/m ³)	(ppbv)		(ug/m ³)	(ppbv)			
108678	1,3,5-Trimethylbenzene		NC	6.0E+00	1.2E+00		6.0E+01	1.2E+01		6.0E+02	1.2E+02		2.5E+01	
108054	Vinyl acetate		NC	2.0E+02	5.7E+01		2.0E+03	5.7E+02		2.0E+04	5.7E+03		9.6E+03	
75014	Vinyl chloride (chloroethene)		C	2.8E+01	1.1E+01		2.8E+02	1.1E+02		2.8E+03	1.1E+03		2.5E+01	

¹ AF = 0.1 for Shallow Soil Gas Target Concentration
 AF = 0.01 for Deep Soil Gas Target Concentration
 AF = 0.001 for Groundwater Target Concentration
 * Health-based target breathing concentration exceeds maximum possible chemical vapor concentration (pathway incomplete)
 ** Target soil gas concentration exceeds maximum possible vapor concentration (pathway incomplete)
 † The target groundwater concentration is the MCL. (The MCL for chloroform is the MCL for total Trihalomethanes. The MCL listed for m-Xylene, o-Xylene, and p-Xylene is the MCL for total Xylenes.)
 †† The target concentration for trichloroethylene is based on the upper bound cancer slope factor identified in EPA's draft risk assessment for trichloroethylene (US EPA, 2001). The slope factor is based on state-of-the-art methodology, however the TCE assessment is still undergoing review. As a result, the slope factor and the target concentration values for TCE may be revised further. (See Appendix D.)

Table 2b: Question 4 Generic Screening Levels and Summary Sheet ¹

Risk = 1 x 10⁻⁵

CAS No.	Chemical	Compounds with Provisional Toxicity Data Extrapolated From Oral Sources	Basis of Target Concentration C=cancer risk NC=noncancer risk	Target Indoor Air Concentration to Satisfy Both the Prescribed Risk Level and the Target Hazard Index [R=10 ⁻⁵ , HI=1) C _{target}		Measured or Reasonably Estimated Indoor Air Concentration [if available] (specify units)	Target Shallow Soil Gas Concentration Corresponding to Target Indoor Air Concentration Where the Soil Gas to Indoor Air Attenuation Factor=0.1 C _{soil-gas}		Measured or Reasonably Estimated Shallow Soil Gas Concentration [if available] (specify units)	Target Deep Soil Gas Concentration Corresponding to Target Indoor Air Concentration Where the Soil Gas to Indoor Air Attenuation Factor=0.01 C _{soil-gas}		Measured or Reasonably Estimated Deep Soil Gas Concentration [if available] (specify units)	Target Groundwater Concentration Corresponding to Target Indoor Air Concentration Where the Soil Gas to Indoor Air Attenuation Factor = 0.001 and Partitioning Across the Water Table Obeys Henry's Law C _{gw}	Measured or Reasonably Estimated Groundwater Concentration [if available] (specify units)
				(ug/m ³)	(ppbv)		(ug/m ³)	(ppbv)		(ug/m ³)	(ppbv)			
83329	Acenaphthene	X	NC	2.1E+02	3.3E+01		2.1E+03	3.3E+02		2.1E+04	3.3E+03		**	
75070	Acetaldehyde		NC	9.0E+00	5.0E+00		9.0E+01	5.0E+01		9.0E+02	5.0E+02		2.8E+03	
67641	Acetone	X	NC	3.5E+02	1.5E+02		3.5E+03	1.5E+03		3.5E+04	1.5E+04		2.2E+05	
75058	Acetonitrile		NC	6.0E+01	3.6E+01		6.0E+02	3.6E+02		6.0E+03	3.6E+03		4.2E+04	
98862	Acetophenone	X	NC	3.5E+02	7.1E+01		3.5E+03	7.1E+02		3.5E+04	7.1E+03		8.0E+05	
107028	Acrolein		NC	2.0E-02	8.7E-03		2.0E-01	8.7E-02		2.0E+00	8.7E-01		4.0E+00	
107131	Acrylonitrile		C	3.6E-01	1.7E-01		3.6E+00	1.7E+00		3.6E+01	1.7E+01		8.5E+01	
309002	Aldrin		C	5.0E-03	3.3E-04		5.0E-02	3.3E-03		5.0E-01	3.3E-02		7.1E-01	
319846	alpha-HCH (alpha-BHC)		C	1.4E-02	1.1E-03		1.4E-01	1.1E-02		1.4E+00	1.1E-01		3.1E+01	
100527	Benzaldehyde	X	NC	3.5E+02	8.1E+01		3.5E+03	8.1E+02		3.5E+04	8.1E+03		3.6E+05	
71432	Benzene		C	3.1E+00	9.8E-01		3.1E+01	9.8E+00		3.1E+02	9.8E+01		1.4E+01	
205992	Benzo(b)fluoranthene	X	C	1.2E-01	1.1E-02		1.2E+00	1.1E-01		**	**		**	
100447	Benzylchloride	X	C	5.0E-01	9.7E-02		5.0E+00	9.7E-01		5.0E+01	9.7E+00		3.0E+01	
91587	beta-Chloronaphthalene	X	NC	2.8E+02	4.2E+01		2.8E+03	4.2E+02		2.8E+04	4.2E+03		**	
92524	Biphenyl	X	NC	1.8E+02	2.8E+01		1.8E+03	2.8E+02		1.8E+04	2.8E+03		**	
111444	Bis(2-chloroethyl)ether		C	7.4E-02	1.3E-02		7.4E-01	1.3E-01		7.4E+00	1.3E+00		1.0E+02	
108601	Bis(2-chloroisopropyl)ether		C	2.4E+00	3.5E-01		2.4E+01	3.5E+00		2.4E+02	3.5E+01		5.1E+02	
542881	Bis(chloromethyl)ether		C	3.9E-04	8.4E-05		3.9E-03	8.4E-04		3.9E-02	8.4E-03		4.5E-02	
75274	Bromodichloromethane	X	C	1.4E+00	2.1E-01		1.4E+01	2.1E+00		1.4E+02	2.1E+01		2.1E+01	
75252	Bromoform		C	2.2E+01	2.1E+00		2.2E+02	2.1E+01		2.2E+03	2.1E+02		8.3E-02	
106990	1,3-Butadiene		C	8.7E-02	3.9E-02		8.7E-01	3.9E-01		8.7E+00	3.9E+00		2.9E-02	
75150	Carbon disulfide		NC	7.0E+02	2.2E+02		7.0E+03	2.2E+03		7.0E+04	2.2E+04		5.6E+02	
56235	Carbon tetrachloride		C	1.6E+00	2.6E-01		1.6E+01	2.6E+00		1.6E+02	2.6E+01		5.0E+00 †	
57749	Chlordane		C	2.4E-01	1.5E-02		2.4E+00	1.5E-01		2.4E+01	1.5E+00		**	
126998	2-Chloro-1,3-butadiene (chloroprene)		NC	7.0E+00	1.9E+00		7.0E+01	1.9E+01		7.0E+02	1.9E+02		1.4E+01	
108907	Chlorobenzene		NC	6.0E+01	1.3E+01		6.0E+02	1.3E+02		6.0E+03	1.3E+03		3.9E+02	
109693	1-Chlorobutane	X	NC	1.4E+03	3.7E+02		1.4E+04	3.7E+03		1.4E+05	3.7E+04		2.0E+03	
124481	Chlorodibromomethane	X	C	1.0E+00	1.2E-01		1.0E+01	1.2E+00		1.0E+02	1.2E+01		3.2E+01	
75456	Chlorodifluoromethane		NC	5.0E+04	1.4E+04		5.0E+05	1.4E+05		**	**		**	
75003	Chloroethane (ethyl chloride)		NC	1.0E+04	3.8E+03		1.0E+05	3.8E+04		1.0E+06	3.8E+05		2.8E+04	
67663	Chloroform		C	1.1E+00	2.2E-01		1.1E+01	2.2E+00		1.1E+02	2.2E+01		8.0E+01 †	
95578	2-Chlorophenol	X	NC	1.8E+01	3.3E+00		1.8E+02	3.3E+01		1.8E+03	3.3E+02		1.1E+03	
75296	2-Chloropropane		NC	1.0E+02	3.2E+01		1.0E+03	3.2E+02		1.0E+04	3.2E+03		1.7E+02	
218019	Chrysene	X	C	1.2E+01	1.2E+00		**	**		**	**		**	
156592	cis-1,2-Dichloroethylene	X	NC	3.5E+01	8.8E+00		3.5E+02	8.8E+01		3.5E+03	8.8E+02		2.1E+02	
123739	Crotonaldehyde (2-butenal)	X	C	4.5E-02	1.6E-02		4.5E-01	1.6E-01		4.5E+00	1.6E+00		5.6E+01	
98828	Cumene		NC	4.0E+02	8.1E+01		4.0E+03	8.1E+02		4.0E+04	8.1E+03		8.4E+00	

Table 2b: Question 4 Generic Screening Levels and Summary Sheet ¹

Risk = 1 x 10⁻⁵

CAS No.	Chemical	Compounds with Provisional Toxicity Data Extrapolated From Oral Sources	Basis of Target Concentration C=cancer risk NC=noncancer risk	Target Indoor Air Concentration to Satisfy Both the Prescribed Risk Level and the Target Hazard Index [R=10 ⁻⁵ , HI=1) C _{target}		Measured or Reasonably Estimated Indoor Air Concentration [if available] (specify units)	Target Shallow Soil Gas Concentration Corresponding to Target Indoor Air Concentration Where the Soil Gas to Indoor Air Attenuation Factor=0.1 C _{soil-gas}		Measured or Reasonably Estimated Shallow Soil Gas Concentration [if available] (specify units)	Target Deep Soil Gas Concentration Corresponding to Target Indoor Air Concentration Where the Soil Gas to Indoor Air Attenuation Factor=0.01 C _{soil-gas}		Measured or Reasonably Estimated Deep Soil Gas Concentration [if available] (specify units)	Target Groundwater Concentration Corresponding to Target Indoor Air Concentration Where the Soil Gas to Indoor Air Attenuation Factor = 0.001 and Partitioning Across the Water Table Obeys Henry's Law C _{gw}	Measured or Reasonably Estimated Groundwater Concentration [if available] (specify units)
				(ug/m ³)	(ppbv)		(ug/m ³)	(ppbv)		(ug/m ³)	(ppbv)			
72559	DDE	X	C	2.5E-01	1.9E-02		2.5E+00	1.9E-01		2.5E+01	1.9E+00		**	
132649	Dibenzofuran	X	NC	1.4E+01	2.0E+00		1.4E+02	2.0E+01		1.4E+03	2.0E+02		**	
96128	1,2-Dibromo-3-chloropropane		NC	2.0E-01	2.1E-02		2.0E+00	2.1E-01		2.0E+01	2.1E+00		3.3E+01	
106934	1,2-Dibromoethane (ethylene dibromide)		C	1.1E-01	1.4E-02		1.1E+00	1.4E-01		1.1E+01	1.4E+00		3.6E+00	
541731	1,3-Dichlorobenzene	X	NC	1.1E+02	1.7E+01		1.1E+03	1.7E+02		1.1E+04	1.7E+03		8.3E+02	
95501	1,2-Dichlorobenzene		NC	2.0E+02	3.3E+01		2.0E+03	3.3E+02		2.0E+04	3.3E+03		2.6E+03	
106467	1,4-Dichlorobenzene		NC	8.0E+02	1.3E+02		8.0E+03	1.3E+03		8.0E+04	1.3E+04		8.2E+03	
75718	Dichlorodifluoromethane		NC	2.0E+02	4.0E+01		2.0E+03	4.0E+02		2.0E+04	4.0E+03		1.4E+01	
75343	1,1-Dichloroethane		NC	5.0E+02	1.2E+02		5.0E+03	1.2E+03		5.0E+04	1.2E+04		2.2E+03	
107062	1,2-Dichloroethane		C	9.4E-01	2.3E-01		9.4E+00	2.3E+00		9.4E+01	2.3E+01		2.3E+01	
75354	1,1-Dichloroethylene		NC	2.0E+02	5.0E+01		2.0E+03	5.0E+02		2.0E+04	5.0E+03		1.9E+02	
78875	1,2-Dichloropropane		NC	4.0E+00	8.7E-01		4.0E+01	8.7E+00		4.0E+02	8.7E+01		3.5E+01	
542756	1,3-Dichloropropene		C	6.1E+00	1.3E+00		6.1E+01	1.3E+01		6.1E+02	1.3E+02		8.4E+00	
60571	Dieldrin		C	5.3E-03	3.4E-04		5.3E-02	3.4E-03		5.3E-01	3.4E-02		8.6E+00	
115297	Endosulfan	X	NC	2.1E+01	1.3E+00		2.1E+02	1.3E+01		**	**		**	
106898	Epichlorohydrin		NC	1.0E+00	2.6E-01		1.0E+01	2.6E+00		1.0E+02	2.6E+01		8.0E+02	
60297	Ethyl ether	X	NC	7.0E+02	2.3E+02		7.0E+03	2.3E+03		7.0E+04	2.3E+04		5.2E+02	
141786	Ethylacetate	X	NC	3.2E+03	8.7E+02		3.2E+04	8.7E+03		3.2E+05	8.7E+04		5.6E+05	
100414	Ethylbenzene		C	2.2E+01	5.1E+00		2.2E+02	5.1E+01		2.2E+03	5.1E+02		7.0E+02 †	
75218	Ethylene oxide		C	2.4E-01	1.4E-01		2.4E+00	1.4E+00		2.4E+01	1.4E+01		1.1E+01	
97632	Ethylmethacrylate	X	NC	3.2E+02	6.8E+01		3.2E+03	6.8E+02		3.2E+04	6.8E+03		9.1E+03	
86737	Fluorene	X	NC	1.4E+02	2.1E+01		1.4E+03	2.1E+02		**	**		**	
110009	Furan	X	NC	3.5E+00	1.3E+00		3.5E+01	1.3E+01		3.5E+02	1.3E+02		1.6E+01	
58899	gamma-HCH (Lindane)	X	C	6.6E-02	5.5E-03		6.6E-01	5.5E-02		6.6E+00	5.5E-01		1.1E+02	
76448	Heptachlor		C	1.9E-02	1.2E-03		1.9E-01	1.2E-02		1.9E+00	1.2E-01		4.0E-01 †	
87683	Hexachloro-1,3-butadiene		C	1.1E+00	1.0E-01		1.1E+01	1.0E+00		1.1E+02	1.0E+01		3.3E+00	
118741	Hexachlorobenzene		C	5.3E-02	4.5E-03		5.3E-01	4.5E-02		5.3E+00	4.5E-01		1.0E+00 †	
77474	Hexachlorocyclopentadiene		NC	2.0E-01	1.8E-02		2.0E+00	1.8E-01		2.0E+01	1.8E+00		5.0E+01 †	
67721	Hexachloroethane		C	6.1E+00	6.3E-01		6.1E+01	6.3E+00		6.1E+02	6.3E+01		3.8E+01	
110543	Hexane		NC	2.0E+02	5.7E+01		2.0E+03	5.7E+02		2.0E+04	5.7E+03		2.9E+00	
74908	Hydrogen cyanide		NC	3.0E+00	2.7E+00		3.0E+01	2.7E+01		3.0E+02	2.7E+02		5.5E+02	
78831	Isobutanol	X	NC	1.1E+03	3.5E+02		1.1E+04	3.5E+03		1.1E+05	3.5E+04		2.2E+06	
743976	Mercury (elemental)		NC	3.0E-01	3.7E-02		3.0E+00	3.7E-01		3.0E+01	3.7E+00		6.8E-01	
126987	Methacrylonitrile		NC	7.0E-01	2.6E-01		7.0E+00	2.6E+00		7.0E+01	2.6E+01		6.9E+01	
72435	Methoxychlor	X	NC	1.8E+01	1.2E+00		**	**		**	**		**	
79209	Methyl acetate	X	NC	3.5E+03	1.2E+03		3.5E+04	1.2E+04		3.5E+05	1.2E+05		7.2E+05	
96333	Methyl acrylate	X	NC	1.1E+02	3.0E+01		1.1E+03	3.0E+02		1.1E+04	3.0E+03		1.4E+04	

Table 2b: Question 4 Generic Screening Levels and Summary Sheet ¹

Risk = 1 x 10⁻⁵

CAS No.	Chemical	Compounds with Provisional Toxicity Data Extrapolated From Oral Sources	Basis of Target Concentration C=cancer risk NC=noncancer risk	Target Indoor Air Concentration to Satisfy Both the Prescribed Risk Level and the Target Hazard Index [R=10 ⁻⁵ , HI=1) C _{target}		Measured or Reasonably Estimated Indoor Air Concentration [if available] (specify units)	Target Shallow Soil Gas Concentration Corresponding to Target Indoor Air Concentration Where the Soil Gas to Indoor Air Attenuation Factor=0.1 C _{soil-gas}		Measured or Reasonably Estimated Shallow Soil Gas Concentration [if available] (specify units)	Target Deep Soil Gas Concentration Corresponding to Target Indoor Air Concentration Where the Soil Gas to Indoor Air Attenuation Factor=0.01 C _{soil-gas}		Measured or Reasonably Estimated Deep Soil Gas Concentration [if available] (specify units)	Target Groundwater Concentration Corresponding to Target Indoor Air Concentration Where the Soil Gas to Indoor Air Attenuation Factor = 0.001 and Partitioning Across the Water Table Obeys Henry's Law C _{gw}	Measured or Reasonably Estimated Groundwater Concentration [if available] (specify units)
				(ug/m ³)	(ppbv)		(ug/m ³)	(ppbv)		(ug/m ³)	(ppbv)			
74839	Methyl bromide		NC	5.0E+00	1.3E+00		5.0E+01	1.3E+01		5.0E+02	1.3E+02		2.0E+01	
74873	Methyl chloride (chloromethane)		C	2.4E+01	1.2E+01		2.4E+02	1.2E+02		2.4E+03	1.2E+03		6.7E+01	
108872	Methylcyclohexane		NC	3.0E+03	7.5E+02		3.0E+04	7.5E+03		3.0E+05	7.5E+04		7.1E+02	
74953	Methylene bromide	X	NC	3.5E+01	4.9E+00		3.5E+02	4.9E+01		3.5E+03	4.9E+02		9.9E+02	
75092	Methylene chloride		C	5.2E+01	1.5E+01		5.2E+02	1.5E+02		5.2E+03	1.5E+03		5.8E+02	
78933	Methyl ethyl ketone (2-butanone)		NC	1.0E+03	3.4E+02		1.0E+04	3.4E+03		1.0E+05	3.4E+04		4.4E+05	
108101	Methyl isobutyl ketone		NC	8.0E+01	2.0E+01		8.0E+02	2.0E+02		8.0E+03	2.0E+03		1.4E+04	
80626	Methyl methacrylate		NC	7.0E+02	1.7E+02		7.0E+03	1.7E+03		7.0E+04	1.7E+04		5.1E+04	
91576	2-Methylnaphthalene	X	NC	7.0E+01	1.2E+01		7.0E+02	1.2E+02		7.0E+03	1.2E+03		3.3E+03	
1634044	MTBE		NC	3.0E+03	8.3E+02		3.0E+04	8.3E+03		3.0E+05	8.3E+04		1.2E+05	
108383	m-Xylene	X	NC	7.0E+03	1.6E+03		7.0E+04	1.6E+04		7.0E+05	1.6E+05		2.3E+04	
91203	Naphthalene		NC	3.0E+00	5.7E-01		3.0E+01	5.7E+00		3.0E+02	5.7E+01		1.5E+02	
104518	n-Butylbenzene	X	NC	1.4E+02	2.6E+01		1.4E+03	2.6E+02		1.4E+04	2.6E+03		2.6E+02	
98953	Nitrobenzene		NC	2.0E+00	4.0E-01		2.0E+01	4.0E+00		2.0E+02	4.0E+01		2.0E+03	
79469	2-Nitropropane		C	9.0E-03	2.5E-03		9.0E-02	2.5E-02		9.0E-01	2.5E-01		1.8E+00	
924163	N-Nitroso-di-n-butylamine		C	1.5E-02	2.4E-03		1.5E-01	2.4E-02		1.5E+00	2.4E-01		1.2E+00	
103651	n-Propylbenzene	X	NC	1.4E+02	2.8E+01		1.4E+03	2.8E+02		1.4E+04	2.8E+03		3.2E+02	
88722	o-Nitrotoluene	X	NC	3.5E+01	6.2E+00		3.5E+02	6.2E+01		3.5E+03	6.2E+02		6.8E+04	
95476	o-Xylene	X	NC	7.0E+03	1.6E+03		7.0E+04	1.6E+04		7.0E+05	1.6E+05		3.3E+04	
106423	p-Xylene	X	NC	7.0E+03	1.6E+03		7.0E+04	1.6E+04		7.0E+05	1.6E+05		2.2E+04	
129000	Pyrene	X	NC	1.1E+02	1.3E+01		**	**		**	**		**	
135988	sec-Butylbenzene	X	NC	1.4E+02	2.6E+01		1.4E+03	2.6E+02		1.4E+04	2.6E+03		2.5E+02	
100425	Styrene		NC	1.0E+03	2.3E+02		1.0E+04	2.3E+03		1.0E+05	2.3E+04		8.9E+03	
98066	tert-Butylbenzene	X	NC	1.4E+02	2.6E+01		1.4E+03	2.6E+02		1.4E+04	2.6E+03		2.9E+02	
630206	1,1,1,2-Tetrachloroethane		C	3.3E+00	4.8E-01		3.3E+01	4.8E+00		3.3E+02	4.8E+01		3.3E+01	
79345	1,1,2,2-Tetrachloroethane		C	4.2E-01	6.1E-02		4.2E+00	6.1E-01		4.2E+01	6.1E+00		3.0E+01	
127184	Tetrachloroethylene		C	8.1E+00	1.2E+00		8.1E+01	1.2E+01		8.1E+02	1.2E+02		1.1E+01	
108883	Toluene		NC	4.0E+02	1.1E+02		4.0E+03	1.1E+03		4.0E+04	1.1E+04		1.5E+03	
156605	trans-1,2-Dichloroethylene	X	NC	7.0E+01	1.8E+01		7.0E+02	1.8E+02		7.0E+03	1.8E+03		1.8E+02	
76131	1,1,2-Trichloro-1,2,2-trifluoroethane		NC	3.0E+04	3.9E+03		3.0E+05	3.9E+04		3.0E+06	3.9E+05		1.5E+03	
120821	1,2,4-Trichlorobenzene		NC	2.0E+02	2.7E+01		2.0E+03	2.7E+02		2.0E+04	2.7E+03		3.4E+03	
79005	1,1,2-Trichloroethane		C	1.5E+00	2.8E-01		1.5E+01	2.8E+00		1.5E+02	2.8E+01		4.1E+01	
71556	1,1,1-Trichloroethane		NC	2.2E+03	4.0E+02		2.2E+04	4.0E+03		2.2E+05	4.0E+04		3.1E+03	
79016	Trichloroethylene ^{††}	X	C	2.2E-01	4.1E-02		2.2E+00	4.1E-01		2.2E+01	4.1E+00		5.0E+00 [†]	
75694	Trichlorofluoromethane		NC	7.0E+02	1.2E+02		7.0E+03	1.2E+03		7.0E+04	1.2E+04		1.8E+02	
96184	1,2,3-Trichloropropane		NC	4.9E+00	8.1E-01		4.9E+01	8.1E+00		4.9E+02	8.1E+01		2.9E+02	
95636	1,2,4-Trimethylbenzene		NC	6.0E+00	1.2E+00		6.0E+01	1.2E+01		6.0E+02	1.2E+02		2.4E+01	

Table 2b: Question 4 Generic Screening Levels and Summary Sheet ¹

Risk = 1×10^{-5}

CAS No.	Chemical	Compounds with Provisional Toxicity Data Extrapolated From Oral Sources	Basis of Target Concentration C=cancer risk NC=noncancer risk	Target Indoor Air Concentration to Satisfy Both the Prescribed Risk Level and the Target Hazard Index [R= 10^{-5} , HI=1) C _{target} (ug/m3) (ppbv)		Measured or Reasonably Estimated Indoor Air Concentration [if available] (specify units)	Target Shallow Soil Gas Concentration Corresponding to Target Indoor Air Concentration Where the Soil Gas to Indoor Air Attenuation Factor=0.1 C _{soil-gas} (ug/m3) (ppbv)		Measured or Reasonably Estimated Shallow Soil Gas Concentration [if available] (specify units)	Target Deep Soil Gas Concentration Corresponding to Target Indoor Air Concentration Where the Soil Gas to Indoor Air Attenuation Factor=0.01 C _{soil-gas} (ug/m3) (ppbv)		Measured or Reasonably Estimated Deep Soil Gas Concentration [if available] (specify units)	Target Groundwater Concentration Corresponding to Target Indoor Air Concentration Where the Soil Gas to Indoor Air Attenuation Factor = 0.001 and Partitioning Across the Water Table Obeys Henry's Law C _{gw} (ug/L)	Measured or Reasonably Estimated Groundwater Concentration [if available] (specify units)
108678	1,3,5-Trimethylbenzene		NC	6.0E+00	1.2E+00		6.0E+01	1.2E+01		6.0E+02	1.2E+02		2.5E+01	
108054	Vinyl acetate		NC	2.0E+02	5.7E+01		2.0E+03	5.7E+02		2.0E+04	5.7E+03		9.6E+03	
75014	Vinyl chloride (chloroethene)		C	2.8E+00	1.1E+00		2.8E+01	1.1E+01		2.8E+02	1.1E+02		2.5E+00	

† AF = 0.1 for Shallow Soil Gas Target Concentration
 AF = 0.01 for Deep Soil Gas Target Concentration
 AF = 0.001 for Groundwater Target Concentration
 * Health-based target breathing concentration exceeds maximum possible chemical vapor concentration (pathway incomplete)
 ** Target soil gas concentration exceeds maximum possible vapor concentration (pathway incomplete)
 † The target groundwater concentration is the MCL. (The MCL for chloroform is the MCL for total Trihalomethanes. The MCL listed for m-Xylene, o-Xylene, and p-Xylene is the MCL for total Xylenes.)
 †† The target concentration for trichloroethylene is based on the upper bound cancer slope factor identified in EPA's draft risk assessment for trichloroethylene (US EPA, 2001). The slope factor is based on state-of-the-art methodology, however the TCE assessment is still undergoing review. As a result, the slope factor and the target concentration values for TCE may be revised further. (See Appendix D.)

Table 2c: Question 4 Generic Screening Levels and Summary Sheet ¹

Risk = 1 x 10⁻⁶

CAS No.	Chemical	Compounds with Provisional Toxicity Data Extrapolated From Oral Sources	Basis of Target Concentration C=cancer risk NC=noncancer risk	Target Indoor Air Concentration to Satisfy Both the Prescribed Risk Level and the Target Hazard Index [R=10 ⁻⁶ , HI=1) C _{target}		Measured or Reasonably Estimated Indoor Air Concentration [if available] (specify units)	Target Shallow Gas Concentration Corresponding to Target Indoor Air Concentration Where the Soil Gas to Indoor Air Attenuation Factor=0.1 C _{soil-gas}		Measured or Reasonably Estimated Shallow Soil Gas Concentration [if available] (specify units)	Target Deep Soil Gas Concentration Corresponding to Target Indoor Air Concentration Where the Soil Gas to Indoor Air Attenuation Factor=0.01 C _{soil-gas}		Measured or Reasonably Estimated Deep Soil Gas Concentration [if available] (specify units)	Target Groundwater Concentration Corresponding to Target Indoor Air Concentration Where the Soil Gas to Indoor Air Attenuation Factor = 0.001 and Partitioning Across the Water Table Obeys Henry's Law C _{gw}	Measured or Reasonably Estimated Groundwater Concentration [if available] (specify units)
				(ug/m3)	(ppbv)		(ug/m3)	(ppbv)		(ug/m3)	(ppbv)			
83329	Acenaphthene	X	NC	2.1E+02	3.3E+01		2.1E+03	3.3E+02		2.1E+04	3.3E+03		**	
75070	Acetaldehyde		C	1.1E+00	6.1E-01		1.1E+01	6.1E+00		1.1E+02	6.1E+01		3.4E+02	
67641	Acetone	X	NC	3.5E+02	1.5E+02		3.5E+03	1.5E+03		3.5E+04	1.5E+04		2.2E+05	
75058	Acetonitrile		NC	6.0E+01	3.6E+01		6.0E+02	3.6E+02		6.0E+03	3.6E+03		4.2E+04	
98862	Acetophenone	X	NC	3.5E+02	7.1E+01		3.5E+03	7.1E+02		3.5E+04	7.1E+03		8.0E+05	
107028	Acrolein		NC	2.0E-02	8.7E-03		2.0E-01	8.7E-02		2.0E+00	8.7E-01		4.0E+00	
107131	Acrylonitrile		C	3.6E-02	1.7E-02		3.6E-01	1.7E-01		3.6E+00	1.7E+00		8.5E+00	
309002	Aldrin		C	5.0E-04	3.3E-05		5.0E-03	3.3E-04		5.0E-02	3.3E-03		7.1E-02	
319846	alpha-HCH (alpha-BHC)		C	1.4E-03	1.1E-04		1.4E-02	1.1E-03		1.4E-01	1.1E-02		3.1E+00	
100527	Benzaldehyde	X	NC	3.5E+02	8.1E+01		3.5E+03	8.1E+02		3.5E+04	8.1E+03		3.6E+05	
71432	Benzene		C	3.1E-01	9.8E-02		3.1E+00	9.8E-01		3.1E+01	9.8E+00		5.0E+00 †	
205992	Benzo(b)fluoranthene	X	C	1.2E-02	1.1E-03		1.2E-01	1.1E-02		1.2E+00	1.1E-01		**	
100447	Benzylchloride	X	C	5.0E-02	9.7E-03		5.0E-01	9.7E-02		5.0E+00	9.7E-01		3.0E+00	
91587	beta-Chloronaphthalene	X	NC	2.8E+02	4.2E+01		2.8E+03	4.2E+02		2.8E+04	4.2E+03		**	
92524	Biphenyl	X	NC	1.8E+02	2.8E+01		1.8E+03	2.8E+02		1.8E+04	2.8E+03		**	
111444	Bis(2-chloroethyl)ether		C	7.4E-03	1.3E-03		7.4E-02	1.3E-02		7.4E-01	1.3E-01		1.0E+01	
108601	Bis(2-chloroisopropyl)ether		C	2.4E-01	3.5E-02		2.4E+00	3.5E-01		2.4E+01	3.5E+00		5.1E+01	
542881	Bis(chloromethyl)ether		C	3.9E-05	8.4E-06		3.9E-04	8.4E-05		3.9E-03	8.4E-04		4.5E-03	
75274	Bromodichloromethane	X	C	1.4E-01	2.1E-02		1.4E+00	2.1E-01		1.4E+03	2.1E+00		2.1E+00	
75252	Bromoform		C	2.2E+00	2.1E-01		2.2E+01	2.1E+00		2.2E+02	2.1E+01		8.3E-03	
106990	1,3-Butadiene		C	8.7E-03	3.9E-03		8.7E-02	3.9E-02		8.7E-01	3.9E-01		2.9E-03	
75150	Carbon disulfide		NC	7.0E+02	2.2E+02		7.0E+03	2.2E+03		7.0E+04	2.2E+04		5.6E+02	
56235	Carbon tetrachloride		C	1.6E-01	2.6E-02		1.6E+00	2.6E-01		1.6E+01	2.6E+00		5.0E+00 †	
57749	Chlordane		C	2.4E-02	1.5E-03		2.4E-01	1.5E-02		2.4E+00	1.5E-01		1.2E+01	
126998	2-Chloro-1,3-butadiene (chloroprene)		NC	7.0E+00	1.9E+00		7.0E+01	1.9E+01		7.0E+02	1.9E+02		1.4E+01	
108907	Chlorobenzene		NC	6.0E+01	1.3E+01		6.0E+02	1.3E+02		6.0E+03	1.3E+03		3.9E+02	
109693	1-Chlorobutane	X	NC	1.4E+03	3.7E+02		1.4E+04	3.7E+03		1.4E+05	3.7E+04		2.0E+03	
124481	Chlorodibromomethane	X	C	1.0E-01	1.2E-02		1.0E+00	1.2E-01		1.0E+01	1.2E+00		3.2E+00	
75456	Chlorodifluoromethane		NC	5.0E+04	1.4E+04		5.0E+05	1.4E+05		**	**		**	
75003	Chloroethane (ethyl chloride)		NC	1.0E+04	3.8E+03		1.0E+05	3.8E+04		1.0E+06	3.8E+05		2.8E+04	
67663	Chloroform		C	1.1E-01	2.2E-02		1.1E+00	2.2E-01		1.1E+01	2.2E+00		8.0E+01 †	
95578	2-Chlorophenol	X	NC	1.8E+01	3.3E+00		1.8E+02	3.3E+01		1.8E+03	3.3E+02		1.1E+03	
75296	2-Chloropropane		NC	1.0E+02	3.2E+01		1.0E+03	3.2E+02		1.0E+04	3.2E+03		1.7E+02	
218019	Chrysene	X	C	1.2E+00	1.2E-01		1.2E+01	1.2E+00		**	**		**	
156592	cis-1,2-Dichloroethylene	X	NC	3.5E+01	8.8E+00		3.5E+02	8.8E+01		3.5E+03	8.8E+02		2.1E+02	
123739	Crotonaldehyde (2-butenal)	X	C	4.5E-03	1.6E-03		4.5E-02	1.6E-02		4.5E-01	1.6E-01		5.6E+00	
98828	Cumene		NC	4.0E+02	8.1E+01		4.0E+03	8.1E+02		4.0E+04	8.1E+03		8.4E+00	

Table 2c: Question 4 Generic Screening Levels and Summary Sheet ¹

Risk = 1 x 10⁻⁶

CAS No.	Chemical	Compounds with Provisional Toxicity Data Extrapolated From Oral Sources	Basis of Target Concentration C=cancer risk NC=noncancer risk	Target Indoor Air Concentration to Satisfy Both the Prescribed Risk Level and the Target Hazard Index [R=10 ⁻⁶ , HI=1) C _{target}		Measured or Reasonably Estimated Indoor Air Concentration [if available] (specify units)	Target Shallow Gas Concentration Corresponding to Target Indoor Air Concentration Where the Soil Gas to Indoor Air Attenuation Factor=0.1 C _{soil-gas}		Measured or Reasonably Estimated Shallow Soil Gas Concentration [if available] (specify units)	Target Deep Soil Gas Concentration Corresponding to Target Indoor Air Concentration Where the Soil Gas to Indoor Air Attenuation Factor=0.01 C _{soil-gas}		Measured or Reasonably Estimated Deep Soil Gas Concentration [if available] (specify units)	Target Groundwater Concentration Corresponding to Target Indoor Air Concentration Where the Soil Gas to Indoor Air Attenuation Factor = 0.001 and Partitioning Across the Water Table Obeys Henry's Law C _{gw}	Measured or Reasonably Estimated Groundwater Concentration [if available] (specify units)
				(ug/m3)	(ppbv)		(ug/m3)	(ppbv)		(ug/m3)	(ppbv)			
72559	DDE	X	C	2.5E-02	1.9E-03		2.5E-01	1.9E-02		2.5E+00	1.9E-01		2.9E+01	
132649	Dibenzofuran	X	NC	1.4E+01	2.0E+00		1.4E+02	2.0E+01		1.4E+03	2.0E+02		**	
96128	1,2-Dibromo-3-chloropropane		NC	2.0E-01	2.1E-02		2.0E+00	2.1E-01		2.0E+01	2.1E+00		3.3E+01	
106934	1,2-Dibromoethane (ethylene dibromide)		C	1.1E-02	1.4E-03		1.1E-01	1.4E-02		1.1E+00	1.4E-01		3.6E-01	
541731	1,3-Dichlorobenzene	X	NC	1.1E+02	1.7E+01		1.1E+03	1.7E+02		1.1E+04	1.7E+03		8.3E+02	
95501	1,2-Dichlorobenzene		NC	2.0E+02	3.3E+01		2.0E+03	3.3E+02		2.0E+04	3.3E+03		2.6E+03	
106467	1,4-Dichlorobenzene		NC	8.0E+02	1.3E+02		8.0E+03	1.3E+03		8.0E+04	1.3E+04		8.2E+03	
75718	Dichlorodifluoromethane		NC	2.0E+02	4.0E+01		2.0E+03	4.0E+02		2.0E+04	4.0E+03		1.4E+01	
75343	1,1-Dichloroethane		NC	5.0E+02	1.2E+02		5.0E+03	1.2E+03		5.0E+04	1.2E+04		2.2E+03	
107062	1,2-Dichloroethane		C	9.4E-02	2.3E-02		9.4E-01	2.3E-01		9.4E+00	2.3E+00		5.0E+00 †	
75354	1,1-Dichloroethylene		NC	2.0E+02	5.0E+01		2.0E+03	5.0E+02		2.0E+04	5.0E+03		1.9E+02	
78875	1,2-Dichloropropane		NC	4.0E+00	8.7E-01		4.0E+01	8.7E+00		4.0E+02	8.7E+01		3.5E+01	
542756	1,3-Dichloropropene		C	6.1E-01	1.3E-01		6.1E+00	1.3E+00		6.1E+01	1.3E+01		8.4E-01	
60571	Dieldrin		C	5.3E-04	3.4E-05		5.3E-03	3.4E-04		5.3E-02	3.4E-03		8.6E-01	
115297	Endosulfan	X	NC	2.1E+01	1.3E+00		2.1E+02	1.3E+01		**	**		**	
106898	Epichlorohydrin		NC	1.0E+00	2.6E-01		1.0E+01	2.6E+00		1.0E+02	2.6E+01		8.0E+02	
60297	Ethyl ether	X	NC	7.0E+02	2.3E+02		7.0E+03	2.3E+03		7.0E+04	2.3E+04		5.2E+02	
141786	Ethylacetate	X	NC	3.2E+03	8.7E+02		3.2E+04	8.7E+03		3.2E+05	8.7E+04		5.6E+05	
100414	Ethylbenzene		C	2.2E+00	5.1E-01		2.2E+01	5.1E+00		2.2E+02	5.1E+01		7.0E+02 †	
75218	Ethylene oxide		C	2.4E-02	1.4E-02		2.4E-01	1.4E-01		2.4E+00	1.4E+00		1.1E+00	
97632	Ethylmethacrylate	X	NC	3.2E+02	6.8E+01		3.2E+03	6.8E+02		3.2E+04	6.8E+03		9.1E+03	
86737	Fluorene	X	NC	1.4E+02	2.1E+01		1.4E+03	2.1E+02		**	**		**	
110009	Furan	X	NC	3.5E+00	1.3E+00		3.5E+01	1.3E+01		3.5E+02	1.3E+02		1.6E+01	
58899	gamma-HCH (Lindane)	X	C	6.6E-03	5.5E-04		6.6E-02	5.5E-03		6.6E-01	5.5E-02		1.1E+01	
76448	Heptachlor		C	1.9E-03	1.2E-04		1.9E-02	1.2E-03		1.9E-01	1.2E-02		4.0E-01 †	
87683	Hexachloro-1,3-butadiene		C	1.1E-01	1.0E-02		1.1E+00	1.0E-01		1.1E+01	1.0E+00		3.3E-01	
118741	Hexachlorobenzene		C	5.3E-03	4.5E-04		5.3E-02	4.5E-03		5.3E-01	4.5E-02		1.0E+00 †	
77474	Hexachlorocyclopentadiene		NC	2.0E-01	1.8E-02		2.0E+00	1.8E-01		2.0E+01	1.8E+00		5.0E+01 †	
67721	Hexachloroethane		C	6.1E-01	6.3E-02		6.1E+00	6.3E-01		6.1E+01	6.3E+00		3.8E+00	
110543	Hexane		NC	2.0E+02	5.7E+01		2.0E+03	5.7E+02		2.0E+04	5.7E+03		2.9E+00	
74908	Hydrogen cyanide		NC	3.0E+00	2.7E+00		3.0E+01	2.7E+01		3.0E+02	2.7E+02		5.5E+02	
78831	Isobutanol	X	NC	1.1E+03	3.5E+02		1.1E+04	3.5E+03		1.1E+05	3.5E+04		2.2E+06	
7439976	Mercury (elemental)		NC	3.0E-01	3.7E-02		3.0E+00	3.7E-01		3.0E+01	3.7E+00		6.8E-01	
126987	Methacrylonitrile		NC	7.0E-01	2.6E-01		7.0E+00	2.6E+00		7.0E+01	2.6E+01		6.9E+01	
72435	Methoxychlor	X	NC	1.8E+01	1.2E+00		**	**		**	**		**	
79209	Methyl acetate	X	NC	3.5E+03	1.2E+03		3.5E+04	1.2E+04		3.5E+05	1.2E+05		7.2E+05	
96333	Methyl acrylate	X	NC	1.1E+02	3.0E+01		1.1E+03	3.0E+02		1.1E+04	3.0E+03		1.4E+04	

Table 2c: Question 4 Generic Screening Levels and Summary Sheet ¹

Risk = 1 x 10⁻⁶

CAS No.	Chemical	Compounds with Provisional Toxicity Data Extrapolated From Oral Sources	Basis of Target Concentration C=cancer risk NC=noncancer risk	Target Indoor Air Concentration to Satisfy Both the Prescribed Risk Level and the Target Hazard Index [R=10 ⁻⁶ , HI=1) C _{target}		Measured or Reasonably Estimated Indoor Air Concentration [if available] (specify units)	Target Shallow Gas Concentration Corresponding to Target Indoor Air Concentration Where the Soil Gas to Indoor Air Attenuation Factor=0.1 C _{soil-gas}		Measured or Reasonably Estimated Shallow Soil Gas Concentration [if available] (specify units)	Target Deep Soil Gas Concentration Corresponding to Target Indoor Air Concentration Where the Soil Gas to Indoor Air Attenuation Factor=0.01 C _{soil-gas}		Measured or Reasonably Estimated Deep Soil Gas Concentration [if available] (specify units)	Target Groundwater Concentration Corresponding to Target Indoor Air Concentration Where the Soil Gas to Indoor Air Attenuation Factor = 0.001 and Partitioning Across the Water Table Obeys Henry's Law C _{gw}	Measured or Reasonably Estimated Groundwater Concentration [if available] (specify units)
				(ug/m3)	(ppbv)		(ug/m3)	(ppbv)		(ug/m3)	(ppbv)			
74839	Methyl bromide		NC	5.0E+00	1.3E+00		5.0E+01	1.3E+01		5.0E+02	1.3E+02		2.0E+01	
74873	Methyl chloride (chloromethane)		C	2.4E+00	1.2E+00		2.4E+01	1.2E+01		2.4E+02	1.2E+02		6.7E+00	
108872	Methylcyclohexane		NC	3.0E+03	7.5E+02		3.0E+04	7.5E+03		3.0E+05	7.5E+04		7.1E+02	
74953	Methylene bromide	X	NC	3.5E+01	4.9E+00		3.5E+02	4.9E+01		3.5E+03	4.9E+02		9.9E+02	
75092	Methylene chloride		C	5.2E+00	1.5E+00		5.2E+01	1.5E+01		5.2E+02	1.5E+02		5.8E+01	
78933	Methylethylketone (2-butanone)		NC	1.0E+03	3.4E+02		1.0E+04	3.4E+03		1.0E+05	3.4E+04		4.4E+05	
108101	Methylisobutylketone		NC	8.0E+01	2.0E+01		8.0E+02	2.0E+02		8.0E+03	2.0E+03		1.4E+04	
80626	Methylmethacrylate		NC	7.0E+02	1.7E+02		7.0E+03	1.7E+03		7.0E+04	1.7E+04		5.1E+04	
91576	2-Methylnaphthalene	X	NC	7.0E+01	1.2E+01		7.0E+02	1.2E+02		7.0E+03	1.2E+03		3.3E+03	
1634044	MTBE		NC	3.0E+03	8.3E+02		3.0E+04	8.3E+03		3.0E+05	8.3E+04		1.2E+05	
108383	m-Xylene	X	NC	7.0E+03	1.6E+03		7.0E+04	1.6E+04		7.0E+05	1.6E+05		2.3E+04	
91203	Naphthalene		NC	3.0E+00	5.7E-01		3.0E+01	5.7E+00		3.0E+02	5.7E+01		1.5E+02	
104518	n-Butylbenzene	X	NC	1.4E+02	2.6E+01		1.4E+03	2.6E+02		1.4E+04	2.6E+03		2.6E+02	
98953	Nitrobenzene		NC	2.0E+00	4.0E-01		2.0E+01	4.0E+00		2.0E+02	4.0E+01		2.0E+03	
79469	2-Nitropropane		C	9.0E-04	2.5E-04		9.0E-03	2.5E-03		9.0E-02	2.5E-02		1.8E-01	
924163	N-Nitroso-di-n-butylamine		C	1.5E-03	2.4E-04		1.5E-02	2.4E-03		1.5E-01	2.4E-02		1.2E-01	
103651	n-Propylbenzene	X	NC	1.4E+02	2.8E+01		1.4E+03	2.8E+02		1.4E+04	2.8E+03		3.2E+02	
88722	o-Nitrotoluene	X	NC	3.5E+01	6.2E+00		3.5E+02	6.2E+01		3.5E+03	6.2E+02		6.8E+04	
95476	o-Xylene	X	NC	7.0E+03	1.6E+03		7.0E+04	1.6E+04		7.0E+05	1.6E+05		3.3E+04	
106423	p-Xylene	X	NC	7.0E+03	1.6E+03		7.0E+04	1.6E+04		7.0E+05	1.6E+05		2.2E+04	
129000	Pyrene	X	NC	1.1E+02	1.3E+01		**	**		**	**		**	
135988	sec-Butylbenzene	X	NC	1.4E+02	2.6E+01		1.4E+03	2.6E+02		1.4E+04	2.6E+03		2.5E+02	
100425	Styrene		NC	1.0E+03	2.3E+02		1.0E+04	2.3E+03		1.0E+05	2.3E+04		8.9E+03	
98066	tert-Butylbenzene	X	NC	1.4E+02	2.6E+01		1.4E+03	2.6E+02		1.4E+04	2.6E+03		2.9E+02	
630206	1,1,1,2-Tetrachloroethane		C	3.3E-01	4.8E-02		3.3E+00	4.8E-01		3.3E+01	4.8E+00		3.3E+00	
79345	1,1,2,2-Tetrachloroethane		C	4.2E-02	6.1E-03		4.2E-01	6.1E-02		4.2E+00	6.1E-01		3.0E+00	
127184	Tetrachloroethylene		C	8.1E-01	1.2E-01		8.1E+00	1.2E+00		8.1E+01	1.2E+01		5.0E+00 †	
108883	Toluene		NC	4.0E+02	1.1E+02		4.0E+03	1.1E+03		4.0E+04	1.1E+04		1.5E+03	
156605	trans-1,2-Dichloroethylene	X	NC	7.0E+01	1.8E+01		7.0E+02	1.8E+02		7.0E+03	1.8E+03		1.8E+02	
76131	1,1,2-Trichloro-1,2,2-trifluoroethane		NC	3.0E+04	3.9E+03		3.0E+05	3.9E+04		3.0E+06	3.9E+05		1.5E+03	
120821	1,2,4-Trichlorobenzene		NC	2.0E+02	2.7E+01		2.0E+03	2.7E+02		2.0E+04	2.7E+03		3.4E+03	
79005	1,1,2-Trichloroethane		C	1.5E-01	2.8E-02		1.5E+00	2.8E-01		1.5E+01	2.8E+00		5.0E+00 †	
71556	1,1,1-Trichloroethane		NC	2.2E+03	4.0E+02		2.2E+04	4.0E+03		2.2E+05	4.0E+04		3.1E+03	
79016	Trichloroethylene ††	X	C	2.2E-02	4.1E-03		2.2E-01	4.1E-02		2.2E+00	4.1E-01		5.0E+00 †	
75694	Trichlorofluoromethane		NC	7.0E+02	1.2E+02		7.0E+03	1.2E+03		7.0E+04	1.2E+04		1.8E+02	
96184	1,2,3-Trichloropropane		NC	4.9E+00	8.1E-01		4.9E+01	8.1E+00		4.9E+02	8.1E+01		2.9E+02	
95636	1,2,4-Trimethylbenzene		NC	6.0E+00	1.2E+00		6.0E+01	1.2E+01		6.0E+02	1.2E+02		2.4E+01	

Table 2c: Question 4 Generic Screening Levels and Summary Sheet ¹

Risk = 1×10^{-6}

CAS No.	Chemical	Compounds with Provisional Toxicity Data Extrapolated From Oral Sources	Basis of Target Concentration C=cancer risk NC=noncancer risk	Target Indoor Air Concentration to Satisfy Both the Prescribed Risk Level and the Target Hazard Index [R= 10^{-6} , HI=1) C _{target}		Measured or Reasonably Estimated Indoor Air Concentration [if available] (specify units)	Target Shallow Gas Concentration Corresponding to Target Indoor Air Concentration Where the Soil Gas to Indoor Air Attenuation Factor=0.1 C _{soil-gas}		Measured or Reasonably Estimated Shallow Soil Gas Concentration [if available] (specify units)	Target Deep Soil Gas Concentration Corresponding to Target Indoor Air Concentration Where the Soil Gas to Indoor Air Attenuation Factor=0.01 C _{soil-gas}		Measured or Reasonably Estimated Deep Soil Gas Concentration [if available] (specify units)	Target Groundwater Concentration Corresponding to Target Indoor Air Concentration Where the Soil Gas to Indoor Air Attenuation Factor = 0.001 and Partitioning Across the Water Table Obeys Henry's Law C _{gw}	Measured or Reasonably Estimated Groundwater Concentration [if available] (specify units)
				(ug/m3)	(ppbv)		(ug/m3)	(ppbv)		(ug/m3)	(ppbv)			
108678	1,3,5-Trimethylbenzene		NC	6.0E+00	1.2E+00		6.0E+01	1.2E+01		6.0E+02	1.2E+02		2.5E+01	
108054	Vinyl acetate		NC	2.0E+02	5.7E+01		2.0E+03	5.7E+02		2.0E+04	5.7E+03		9.6E+03	
75014	Vinyl chloride (chloroethene)		C	2.8E-01	1.1E-01		2.8E+00	1.1E+00		2.8E+01	1.1E+01		2.0E+00 †	

¹ AF = 0.1 for Shallow Soil Gas Target Concentration
 AF = 0.01 for Deep Soil Gas Target Concentration
 AF = 0.001 for Groundwater Target Concentration
 * Health-based target breathing concentration exceeds maximum possible chemical vapor concentration (pathway incomplete)
 ** Target soil gas concentration exceeds maximum possible vapor concentration (pathway incomplete)
 † The target groundwater concentration is the MCL. (The MCL for chloroform is the MCL for total Trihalomethanes. The MCL listed for m-Xylene, o-Xylene, and p-Xylene is the MCL for total Xylenes.)
 †† The target concentration for trichloroethylene is based on the upper bound cancer slope factor identified in EPA's draft risk assessment for trichloroethylene (US EPA, 2001). The slope factor is based on state-of-the-art methodology, however the TCE assessment is still undergoing review. As a result, the slope factor and the target concentration values for TCE may be revised further. (See Appendix D.)

Table 3a-SG: Question 5 Soil Gas Screening Levels for Scenario-Specific Vapor Attenuation Factors (α)

Risk = 1×10^{-4}

DRAFT

Target Soil Gas Concentrations for Different Attenuation Factors													
CAS No.	Chemical	Compounds with Provisional Toxicity Data Extrapolated From Oral Sources	Basis of Target Concentration C=cancer risk NC=noncancer risk	$\alpha = 2 \times 10^{-3}$		$\alpha = 1 \times 10^{-3}$		$\alpha = 7 \times 10^{-4}$		$\alpha = 4 \times 10^{-4}$		$\alpha = 2 \times 10^{-4}$	
				$C_{soil-gas}$ (ug/m ³)	(ppbv)	(ug/m ³)	(ppbv)	(ug/m ³)	(ppbv)	(ug/m ³)	(ppbv)	(ug/m ³)	(ppbv)
83329	Acenaphthene	X	NC	**	**	**	**	**	**	**	**	**	**
75070	Acetaldehyde		NC	4.5E+03	2.5E+03	9.0E+03	5.0E+03	1.3E+04	7.1E+03	2.2E+04	1.2E+04	4.5E+04	2.5E+04
67641	Acetone	X	NC	1.8E+05	7.4E+04	3.5E+05	1.5E+05	5.0E+05	2.1E+05	8.8E+05	3.7E+05	1.8E+06	7.4E+05
75058	Acetonitrile		NC	3.0E+04	1.8E+04	6.0E+04	3.6E+04	8.6E+04	5.1E+04	1.5E+05	8.9E+04	3.0E+05	1.8E+05
98862	Acetophenone	X	NC	1.8E+05	3.6E+04	3.5E+05	7.1E+04	5.0E+05	1.0E+05	8.8E+05	1.8E+05	1.8E+06	3.6E+05
107028	Acrolein		NC	1.0E+01	4.4E+00	2.0E+01	8.7E+00	2.9E+01	1.2E+01	5.0E+01	2.2E+01	1.0E+02	4.4E+01
107131	Acrylonitrile		NC	1.0E+03	4.6E+02	2.0E+03	9.2E+02	2.9E+03	1.3E+03	5.0E+03	2.3E+03	1.0E+04	4.6E+03
309002	Aldrin		C	2.5E+01	1.7E+00	5.0E+01	3.3E+02	7.1E+01	4.8E+00	**	**	**	**
319846	alpha-HCH (alpha-BHC)		C	6.8E+01	5.7E+00	1.4E+02	1.1E+01	1.9E+02	1.6E+01	3.4E+02	2.8E+01	6.8E+02	5.7E+01
100527	Benzaldehyde	X	NC	1.8E+05	4.0E+04	3.5E+05	8.1E+04	5.0E+05	1.2E+05	8.8E+05	2.0E+05	1.8E+06	4.0E+05
71432	Benzene		C	1.6E+04	4.9E+03	3.1E+04	9.8E+03	4.5E+04	1.4E+04	7.8E+04	2.4E+04	1.6E+05	4.9E+04
205992	Benzo(b)fluoranthene	X	C	**	**	**	**	**	**	**	**	**	**
100447	Benzylchloride	X	C	2.5E+03	4.8E+02	5.0E+03	9.7E+02	7.2E+03	1.4E+03	1.3E+04	2.4E+03	2.5E+04	4.8E+03
91587	beta-Chloronaphthalene	X	NC	1.4E+05	2.1E+04	**	**	**	**	**	**	**	**
92524	Biphenyl	X	NC	8.8E+04	1.4E+04	**	**	**	**	**	**	**	**
114444	Bis(2-chloroethoxy)ether		C	3.7E+02	6.3E+01	7.4E+02	1.3E+02	1.1E+03	1.8E+02	1.8E+03	3.2E+02	3.7E+03	6.3E+02
108601	Bis(2-chloroisopropyl)ether		C	1.2E+04	1.7E+03	2.4E+04	3.5E+03	3.5E+04	5.0E+03	6.1E+04	8.7E+03	1.2E+05	1.7E+04
542881	Bis(chloromethyl)ether		C	2.0E+00	4.2E-01	3.9E+00	8.4E-01	5.6E+00	1.2E+00	9.8E+00	2.1E+00	2.0E+01	4.2E+00
75274	Bromodichloromethane	X	C	6.9E+03	1.0E+03	1.4E+04	2.1E+03	2.0E+04	2.9E+03	3.4E+04	5.1E+03	6.9E+04	1.0E+04
75252	Bromoform		C	1.1E+05	1.1E+04	2.2E+05	2.1E+04	3.2E+05	3.1E+04	5.5E+05	5.4E+04	1.1E+06	1.1E+05
106990	1,3-Butadiene		C	4.3E+02	2.0E+02	8.7E+02	3.9E+02	1.2E+03	5.6E+02	2.2E+03	9.8E+02	4.3E+03	2.0E+03
75150	Carbon disulfide		NC	3.5E+05	1.1E+05	7.0E+05	2.2E+05	1.0E+06	3.2E+05	1.8E+06	5.6E+05	3.5E+06	1.1E+06
56235	Carbon tetrachloride		C	8.1E+03	1.3E+03	1.6E+04	2.6E+03	2.3E+04	3.7E+03	4.1E+04	6.5E+03	8.1E+04	1.3E+04
57749	Chlordane		NC	**	**	**	**	**	**	**	**	**	**
126998	2-Chloro-1,3-butadiene (chloroprene)		NC	3.5E+03	9.7E+02	7.0E+03	1.9E+03	1.0E+04	2.8E+03	1.8E+04	4.8E+03	3.5E+04	9.7E+03
108907	Chlorobenzene		NC	3.0E+04	6.5E+03	6.0E+04	1.3E+04	8.5E+04	1.8E+04	1.5E+05	3.2E+04	3.0E+05	6.5E+04
109693	1-Chlorobutane	X	NC	7.0E+05	1.8E+05	1.4E+06	3.7E+05	2.0E+06	5.3E+05	3.5E+06	9.2E+05	7.0E+06	1.8E+06
124481	Chlorodibromomethane	X	C	5.1E+03	6.0E+02	1.0E+04	1.2E+03	1.4E+04	1.7E+03	2.5E+04	3.0E+03	5.1E+04	6.0E+03
75456	Chlorodifluoromethane		NC	**	**	**	**	**	**	**	**	**	**
75003	Chloroethane (ethyl chloride)		NC	5.0E+06	1.9E+06	1.0E+07	3.8E+06	1.4E+07	5.4E+06	2.5E+07	9.5E+06	5.0E+07	1.9E+07
67663	Chloroform		C	5.3E+03	1.1E+03	1.1E+04	2.2E+03	1.5E+04	3.1E+03	2.6E+04	5.4E+03	5.3E+04	1.1E+04
95578	2-Chlorophenol	X	NC	8.8E+03	1.7E+03	1.8E+04	3.3E+03	2.5E+04	4.8E+03	4.4E+04	8.3E+03	8.8E+04	1.7E+04
75296	2-Chloropropane		NC	5.1E+04	1.6E+04	1.0E+05	3.2E+04	1.5E+05	4.5E+04	2.5E+05	7.9E+04	5.1E+05	1.6E+05
218019	Chrysene	X	*	*	*	*	*	*	*	*	*	*	*
156592	cis-1,2-Dichloroethylene	X	NC	1.8E+04	4.4E+03	3.5E+04	8.8E+03	5.0E+04	1.3E+04	8.8E+04	2.2E+04	1.8E+05	4.4E+04
123739	Crotonaldehyde (2-butenal)	X	C	2.2E+02	7.8E+01	4.5E+02	1.6E+02	6.4E+02	2.2E+02	1.1E+03	3.9E+02	2.2E+03	7.8E+02
98828	Cumene		NC	2.0E+05	4.1E+04	4.0E+05	8.1E+04	5.7E+05	1.2E+05	1.0E+06	2.0E+05	2.0E+06	4.1E+05
72559	DDE	X	C	**	**	**	**	**	**	**	**	**	**
132649	Dibenzofuran	X	NC	**	**	**	**	**	**	**	**	**	**
96128	1,2-Dibromo-3-chloropropane		NC	1.0E+02	1.0E+01	2.0E+02	2.1E+01	2.9E+02	3.0E+01	5.0E+02	5.2E+01	1.0E+03	1.0E+02
106934	1,2-Dibromoethane (ethylene dibromide)		NC	1.0E+02	1.3E+01	2.0E+02	2.6E+01	2.9E+02	3.7E+01	5.0E+02	6.5E+01	1.0E+03	1.3E+02
541731	1,3-Dichlorobenzene	X	NC	5.3E+04	8.7E+03	1.1E+05	1.7E+04	1.5E+05	2.5E+04	2.6E+05	4.4E+04	5.3E+05	8.7E+04

DRAFT

Table 3a-SG: Question 5 Soil Gas Screening Levels for Scenario-Specific Vapor Attenuation Factors (α)

Risk = 1×10^{-4}

DRAFT

Target Soil Gas Concentrations for Different Attenuation Factors													
CAS No.	Chemical	Compounds with Provisional Toxicity Data Extrapolated From Oral Sources	Basis of Target Concentration C=cancer risk NC=noncancer risk	$\alpha = 2 \times 10^{-3}$		$\alpha = 1 \times 10^{-3}$		$\alpha = 7 \times 10^{-4}$		$\alpha = 4 \times 10^{-4}$		$\alpha = 2 \times 10^{-4}$	
				$C_{soil-gas}$ (ug/m ³)	(ppbv)	(ug/m ³)	(ppbv)	(ug/m ³)	(ppbv)	(ug/m ³)	(ppbv)	(ug/m ³)	(ppbv)
95501	1,2-Dichlorobenzene		NC	1.0E+05	1.7E+04	2.0E+05	3.3E+04	2.9E+05	4.8E+04	5.0E+05	8.3E+04	1.0E+06	1.7E+05
106467	1,4-Dichlorobenzene		NC	4.0E+05	6.7E+04	8.0E+05	1.3E+05	1.1E+06	1.9E+05	2.0E+06	3.3E+05	4.0E+06	6.7E+05
75718	Dichlorodifluoromethane		NC	1.0E+05	2.0E+04	2.0E+05	4.0E+04	2.9E+05	5.8E+04	5.0E+05	1.0E+05	1.0E+06	2.0E+05
75343	1,1-Dichloroethane		NC	2.5E+05	6.2E+04	5.0E+05	1.2E+05	7.1E+05	1.8E+05	1.3E+06	3.1E+05	2.5E+06	6.2E+05
107062	1,2-Dichloroethane		C	4.7E+03	1.2E+03	9.4E+03	2.3E+03	1.3E+04	3.3E+03	2.3E+04	5.8E+03	4.7E+04	1.2E+04
75354	1,1-Dichloroethylene		NC	1.0E+05	2.5E+04	2.0E+05	5.0E+04	2.9E+05	7.2E+04	5.0E+05	1.3E+05	1.0E+06	2.5E+05
78875	1,2-Dichloropropane		NC	2.0E+03	4.3E+02	4.0E+03	8.7E+02	5.7E+03	1.2E+03	1.0E+04	2.2E+03	2.0E+04	4.3E+03
542756	1,3-Dichloropropene		NC	1.0E+04	2.2E+03	2.0E+04	4.4E+03	2.9E+04	6.3E+03	5.0E+04	1.1E+04	1.0E+05	2.2E+04
60571	Dieldrin		C	2.6E+01	1.7E+00	5.3E+01	3.4E+00	7.6E+01	4.9E+00	**	**	**	**
115297	Endosulfan	X	NC	**	**	**	**	**	**	**	**	**	**
108898	Epichlorohydrin		NC	5.0E+02	1.3E+02	1.0E+03	2.6E+02	1.4E+03	3.8E+02	2.5E+03	6.6E+02	5.0E+03	1.3E+03
60297	Ethyl ether	X	NC	3.5E+05	1.2E+05	7.0E+05	2.3E+05	1.0E+06	3.3E+05	1.8E+06	5.8E+05	3.5E+06	1.2E+06
141786	Ethylacetate	X	NC	1.6E+06	4.4E+05	3.2E+06	8.7E+05	4.5E+06	1.2E+06	7.9E+06	2.2E+06	1.6E+07	4.4E+06
100414	Ethylbenzene		C	1.1E+05	2.5E+04	2.2E+05	5.1E+04	3.2E+05	7.3E+04	5.5E+05	1.3E+05	1.1E+06	2.5E+05
75218	Ethylene oxide		C	1.2E+03	6.8E+02	2.4E+03	1.4E+03	3.5E+03	1.9E+03	6.1E+03	3.4E+03	1.2E+04	6.8E+03
97632	Ethylmethacrylate	X	NC	1.6E+05	3.4E+04	3.2E+05	6.8E+04	4.5E+05	9.6E+04	7.9E+05	1.7E+05	1.6E+06	3.4E+05
86737	Fluorene	X	NC	**	**	**	**	**	**	**	**	**	**
110009	Furan	X	NC	1.8E+03	6.3E+02	3.5E+03	1.3E+03	5.0E+03	1.8E+03	8.8E+03	3.1E+03	1.8E+04	6.3E+03
58899	gamma-HCH (Lindane)	X	C	3.3E+02	2.8E+01	6.6E+02	5.5E+01	9.4E+02	7.9E+01	1.6E+03	1.4E+02	3.3E+03	2.8E+02
76448	Heptachlor		C	9.4E+01	6.1E+00	1.9E+02	1.2E+01	2.7E+02	1.8E+01	4.7E+02	3.1E+01	9.4E+02	6.1E+01
87683	Hexachloro-1,3-butadiene		C	5.5E+03	5.2E+02	1.1E+04	1.0E+03	1.6E+04	1.5E+03	2.8E+04	2.6E+03	5.5E+04	5.2E+03
118741	Hexachlorobenzene		C	2.6E+02	2.3E+01	**	**	**	**	**	**	**	**
77474	Hexachlorocyclopentadiene		NC	1.0E+02	9.0E+00	2.0E+02	1.8E+01	2.9E+02	2.6E+01	5.0E+02	4.5E+01	1.0E+03	9.0E+01
67721	Hexachloroethane		C	3.0E+04	3.1E+03	6.1E+04	6.3E+03	8.7E+04	9.0E+03	1.5E+05	1.6E+04	3.0E+05	3.1E+04
110543	Hexane		NC	1.0E+05	2.8E+04	2.0E+05	5.7E+04	2.9E+05	8.1E+04	5.0E+05	1.4E+05	1.0E+06	2.8E+05
74908	Hydrogen cyanide		NC	1.5E+03	1.4E+03	3.0E+03	2.7E+03	4.3E+03	3.9E+03	7.5E+03	6.8E+03	1.5E+04	1.4E+04
78831	Isobutanol	X	NC	5.3E+05	1.7E+05	1.1E+06	3.5E+05	1.5E+06	5.0E+05	2.6E+06	8.7E+05	5.3E+06	1.7E+06
7439976	Mercury (elemental)		NC	1.5E+02	1.8E+01	3.0E+02	3.7E+01	4.3E+02	5.2E+01	7.5E+02	9.1E+01	1.5E+03	1.8E+02
126987	Methacrylonitrile		NC	3.5E+02	1.3E+02	7.0E+02	2.6E+02	1.0E+03	3.6E+02	1.8E+03	6.4E+02	3.5E+03	1.3E+03
72435	Methoxychlor	X	NC	**	**	**	**	**	**	**	**	**	**
79209	Methyl acetate	X	NC	1.8E+06	5.8E+05	3.5E+06	1.2E+06	5.0E+06	1.7E+06	8.8E+06	2.9E+06	**	**
96333	Methyl acrylate	X	NC	5.3E+04	1.5E+04	1.1E+05	3.0E+04	1.5E+05	4.3E+04	2.6E+05	7.5E+04	5.3E+05	1.5E+05
74839	Methyl bromide		NC	2.5E+03	6.4E+02	5.0E+03	1.3E+03	7.1E+03	1.8E+03	1.3E+04	3.2E+03	2.5E+04	6.4E+03
74873	Methyl chloride (chloromethane)		NC	4.5E+04	2.2E+04	9.0E+04	4.4E+04	1.3E+05	6.2E+04	2.3E+05	1.1E+05	4.5E+05	2.2E+05
108872	Methylcyclohexane		NC	1.5E+06	3.7E+05	3.0E+06	7.5E+05	4.3E+06	1.1E+06	7.5E+06	1.9E+06	1.5E+07	3.7E+06
74953	Methylene bromide	X	NC	1.8E+04	2.5E+03	3.5E+04	4.9E+03	5.0E+04	7.0E+03	8.8E+04	1.2E+04	1.8E+05	2.5E+04
75092	Methylene chloride		C	2.6E+05	7.5E+04	5.2E+05	1.5E+05	7.4E+05	2.1E+05	1.3E+06	3.7E+05	2.6E+06	7.5E+05
78933	Methylethylketone (2-butanone)		NC	5.0E+05	1.7E+05	1.0E+06	3.4E+05	1.4E+06	4.8E+05	2.5E+06	8.5E+05	5.0E+06	1.7E+06
108101	Methylisobutylketone		NC	4.0E+04	9.8E+03	8.0E+04	2.0E+04	1.1E+05	2.8E+04	2.0E+05	4.9E+04	4.0E+05	9.8E+04
80626	Methylmethacrylate		NC	3.5E+05	8.6E+04	7.0E+05	1.7E+05	1.0E+06	2.4E+05	1.8E+06	4.3E+05	3.5E+06	8.6E+05
91576	2-Methylnaphthalene	X	NC	3.5E+04	6.0E+03	7.0E+04	1.2E+04	1.0E+05	1.7E+04	1.8E+05	3.0E+04	3.5E+05	6.0E+04
1634044	MTBE		NC	1.5E+06	4.2E+05	3.0E+06	8.3E+05	4.3E+06	1.2E+06	7.5E+06	2.1E+06	1.5E+07	4.2E+06

DRAFT

Table 3a-SG: Question 5 Soil Gas Screening Levels for Scenario-Specific Vapor Attenuation Factors (α)

DRAFT

Risk = 1×10^{-4}

Target Soil Gas Concentrations for Different Attenuation Factors													
CAS No.	Chemical	Compounds with Provisional Toxicity Data Extrapolated From Oral Sources	Basis of Target Concentration C=cancer risk NC=noncancer risk	$\alpha = 2 \times 10^{-3}$		$\alpha = 1 \times 10^{-3}$		$\alpha = 7 \times 10^{-4}$		$\alpha = 4 \times 10^{-4}$		$\alpha = 2 \times 10^{-4}$	
				$C_{soil-gas}$ (ug/m ³)	(ppbv)	(ug/m ³)	(ppbv)	(ug/m ³)	(ppbv)	(ug/m ³)	(ppbv)	(ug/m ³)	(ppbv)
108383	m-Xylene	X	NC	3.5E+06	8.1E+05	7.0E+06	1.6E+06	1.0E+07	2.3E+06	1.8E+07	4.0E+06	3.5E+07	8.1E+06
91203	Naphthalene		NC	1.5E+03	2.9E+02	3.0E+03	5.7E+02	4.3E+03	8.2E+02	7.5E+03	1.4E+03	1.5E+04	2.9E+03
104518	n-Butylbenzene	X	NC	7.0E+04	1.3E+04	1.4E+05	2.6E+04	2.0E+05	3.6E+04	3.5E+05	6.4E+04	7.0E+05	1.3E+05
98953	Nitrobenzene		NC	1.0E+03	2.0E+02	2.0E+03	4.0E+02	2.9E+03	5.7E+02	5.0E+03	9.9E+02	1.0E+04	2.0E+03
79469	2-Nitropropane		C	4.5E+01	1.2E+01	9.0E+01	2.5E+01	1.3E+02	3.5E+01	2.3E+02	6.2E+01	4.5E+02	1.2E+02
924163	N-Nitroso-di-n-butylamine		C	7.6E+01	1.2E+01	1.5E+02	2.4E+01	2.2E+02	3.4E+01	3.8E+02	5.9E+01	7.6E+02	1.2E+02
103651	n-Propylbenzene	X	NC	7.0E+04	1.4E+04	1.4E+05	2.8E+04	2.0E+05	4.1E+04	3.5E+05	7.1E+04	7.0E+05	1.4E+05
88722	o-Nitrotoluene	X	NC	1.8E+04	3.1E+03	3.5E+04	6.2E+03	5.0E+04	8.9E+03	8.8E+04	1.6E+04	1.8E+05	3.1E+04
95476	o-Xylene	X	NC	3.5E+06	8.1E+05	7.0E+06	1.6E+06	1.0E+07	2.3E+06	1.8E+07	4.0E+06	3.5E+07	8.1E+06
106423	p-Xylene	X	NC	3.5E+06	8.1E+05	7.0E+06	1.6E+06	1.0E+07	2.3E+06	1.8E+07	4.0E+06	3.5E+07	8.1E+06
129000	Pyrene	X	NC	**	**	**	**	**	**	**	**	**	**
135988	sec-Butylbenzene	X	NC	7.0E+04	1.3E+04	1.4E+05	2.6E+04	2.0E+05	3.6E+04	3.5E+05	6.4E+04	7.0E+05	1.3E+05
100425	Styrene		NC	5.0E+05	1.2E+05	1.0E+06	2.3E+05	1.4E+06	3.4E+05	2.5E+06	5.9E+05	5.0E+06	1.2E+06
98066	tert-Butylbenzene	X	NC	7.0E+04	1.3E+04	1.4E+05	2.6E+04	2.0E+05	3.6E+04	3.5E+05	6.4E+04	7.0E+05	1.3E+05
630206	1,1,1,2-Tetrachloroethane		C	1.6E+04	2.4E+03	3.3E+04	4.8E+03	4.7E+04	6.8E+03	8.2E+04	1.2E+04	1.6E+05	2.4E+04
79345	1,1,2,2-Tetrachloroethane		C	2.1E+03	3.1E+02	4.2E+03	6.1E+02	6.0E+03	8.7E+02	1.0E+04	1.5E+03	2.1E+04	3.1E+03
127184	Tetrachloroethylene		C	4.1E+04	6.0E+03	8.1E+04	1.2E+04	1.2E+05	1.7E+04	2.0E+05	3.0E+04	4.1E+05	6.0E+04
108883	Toluene		NC	2.0E+05	5.3E+04	4.0E+05	1.1E+05	5.7E+05	1.5E+05	1.0E+06	2.7E+05	2.0E+06	5.3E+05
156605	trans-1,2-Dichloroethylene	X	NC	3.5E+04	8.8E+03	7.0E+04	1.8E+04	1.0E+05	2.5E+04	1.8E+05	4.4E+04	3.5E+05	8.8E+04
76131	1,1,2-Trichloro-1,2,2-trifluoroethane		NC	1.5E+07	2.0E+06	3.0E+07	3.9E+06	4.3E+07	5.6E+06	7.5E+07	9.8E+06	1.5E+08	2.0E+07
120821	1,2,4-Trichlorobenzene		NC	1.0E+05	1.3E+04	2.0E+05	2.7E+04	2.9E+05	3.8E+04	5.0E+05	6.7E+04	1.0E+06	1.3E+05
79005	1,1,2-Trichloroethane		C	7.6E+03	1.4E+03	1.5E+04	2.8E+03	2.2E+04	4.0E+03	3.8E+04	7.0E+03	7.6E+04	1.4E+04
71556	1,1,1-Trichloroethane		NC	1.1E+06	2.0E+05	2.2E+06	4.0E+05	3.1E+06	5.8E+05	5.5E+06	1.0E+06	1.1E+07	2.0E+06
79016	Trichloroethylene ^{††}	X	C	1.1E+03	2.1E+02	2.2E+03	4.1E+02	3.2E+03	5.9E+02	5.5E+03	1.0E+03	1.1E+04	2.1E+03
75694	Trichlorofluoromethane		NC	3.5E+05	6.2E+04	7.0E+05	1.2E+05	1.0E+06	1.8E+05	1.8E+06	3.1E+05	3.5E+06	6.2E+05
96184	1,2,3-Trichloropropane		NC	2.5E+03	4.1E+02	4.9E+03	8.1E+02	7.0E+03	1.2E+03	1.2E+04	2.0E+03	2.5E+04	4.1E+03
95636	1,2,4-Trimethylbenzene		NC	3.0E+03	6.1E+02	6.0E+03	1.2E+03	8.5E+03	1.7E+03	1.5E+04	3.0E+03	3.0E+04	6.1E+03
108678	1,3,5-Trimethylbenzene		NC	3.0E+03	6.1E+02	6.0E+03	1.2E+03	8.5E+03	1.7E+03	1.5E+04	3.0E+03	3.0E+04	6.1E+03
108054	Vinyl acetate		NC	1.0E+05	2.8E+04	2.0E+05	5.7E+04	2.9E+05	8.1E+04	5.0E+05	1.4E+05	1.0E+06	2.8E+05
75014	Vinyl chloride (chloroethene)		C	1.4E+04	5.4E+03	2.8E+04	1.1E+04	4.0E+04	1.5E+04	6.9E+04	2.7E+04	1.4E+05	5.4E+04

* Health-based target breathing concentration exceeds maximum possible chemical vapor concentration (pathway incomplete)

** Target soil gas concentration exceeds maximum possible vapor concentration at this soil gas to indoor air attenuation factor (pathway incomplete)

†† The target concentration for trichloroethylene is based on the upper bound cancer slope factor identified in EPA's draft risk assessment for trichloroethylene (US EPA, 2001). The slope factor is based on state-of-the-art methodology, however the TCE assessment is still undergoing review. As a result, the slope factor and the target concentration values for TCE may be revised further. (See Appendix D.)

DRAFT

Table 3b-SG: Question 5 Soil Gas Screening Levels for Scenario-Specific Vapor Attenuation Factors (a)

Risk = 1×10^{-5}

DRAFT

CAS No.	Chemical	Compounds with Provisional Toxicity Data Extrapolated From Oral Sources	Basis of Target Concentration C=cancer risk NC=noncancer risk	Target Soil Gas Concentrations for Different Attenuation Factors									
				$\alpha = 2 \times 10^{-3}$		$\alpha = 1 \times 10^{-3}$		$\alpha = 7 \times 10^{-4}$		$\alpha = 4 \times 10^{-4}$		$\alpha = 2 \times 10^{-4}$	
				$C_{soil-gas}$ (ug/m ³)	(ppbv)	$C_{soil-gas}$ (ug/m ³)	(ppbv)	$C_{soil-gas}$ (ug/m ³)	(ppbv)	$C_{soil-gas}$ (ug/m ³)	(ppbv)	$C_{soil-gas}$ (ug/m ³)	(ppbv)
83329	Acenaphthene	X	NC	**	**	**	**	**	**	**	**	**	**
75070	Acetaldehyde		NC	4.5E+03	2.5E+03	9.0E+03	5.0E+03	1.3E+04	7.1E+03	2.2E+04	1.2E+04	4.5E+04	2.5E+04
67641	Acetone	X	NC	1.8E+05	7.4E+04	3.5E+05	1.5E+05	5.0E+05	2.1E+05	8.8E+05	3.7E+05	1.8E+06	7.4E+05
75058	Acetonitrile		NC	3.0E+04	1.8E+04	6.0E+04	3.6E+04	8.6E+04	5.1E+04	1.5E+05	8.9E+04	3.0E+05	1.8E+05
98862	Acetophenone	X	NC	1.8E+05	3.6E+04	3.5E+05	7.1E+04	5.0E+05	1.0E+05	8.8E+05	1.8E+05	1.8E+06	3.6E+05
107028	Acrolein		NC	1.0E+01	4.4E+00	2.0E+01	8.7E+00	2.9E+01	1.2E+01	5.0E+01	2.2E+01	1.0E+02	4.4E+01
107131	Acrylonitrile		C	1.8E+02	8.3E+01	3.6E+02	1.7E+02	5.1E+02	2.4E+02	8.9E+02	4.1E+02	1.8E+03	8.3E+02
309002	Aldrin		C	2.5E+00	1.7E-01	5.0E+00	3.3E-01	7.1E+00	4.8E-01	1.2E+01	8.3E-01	2.5E+01	1.7E+00
319846	alpha-HCH (alpha-BHC)		C	6.8E+00	5.7E-01	1.4E+01	1.1E+00	1.9E+01	1.6E+00	3.4E+01	2.8E+00	6.8E+01	5.7E+00
100527	Benzaldehyde	X	NC	1.8E+05	4.0E+04	3.5E+05	8.1E+04	5.0E+05	1.2E+05	8.8E+05	2.0E+05	1.8E+06	4.0E+05
71432	Benzene		C	1.6E+03	4.9E+02	3.1E+03	9.8E+02	4.5E+03	1.4E+03	7.8E+03	2.4E+03	1.6E+04	4.9E+03
205992	Benzo(b)fluoranthene	X	C	**	**	**	**	**	**	**	**	**	**
100447	Benzylchloride	X	C	2.5E+02	4.8E+01	5.0E+02	9.7E+01	7.2E+02	1.4E+02	1.3E+03	2.4E+02	2.5E+03	4.8E+02
91587	beta-Chloronaphthalene	X	NC	1.4E+05	2.1E+04	**	**	**	**	**	**	**	**
92524	Biphenyl	X	NC	8.8E+04	1.4E+04	**	**	**	**	**	**	**	**
114444	Bis(2-chloroethoxy)ether		C	3.7E+01	6.3E+00	7.4E+01	1.3E+01	1.1E+02	1.8E+01	1.8E+02	3.2E+01	3.7E+02	6.3E+01
108601	Bis(2-chloroisopropyl)ether		C	1.2E+03	1.7E+02	2.4E+03	3.5E+02	3.5E+03	5.0E+02	6.1E+03	8.7E+02	1.2E+04	1.7E+03
542881	Bis(chloromethyl)ether		C	2.0E-01	4.2E-02	3.9E-01	8.4E-02	5.6E-01	1.2E-01	9.8E-01	2.1E-01	2.0E+00	4.2E-01
75274	Bromodichloromethane	X	C	6.9E+02	1.0E+02	1.4E+03	2.1E+02	2.0E+03	2.9E+02	3.4E+03	5.1E+02	6.9E+03	1.0E+03
75252	Bromoform		C	1.1E+04	1.1E+03	2.2E+04	2.1E+03	3.2E+04	3.1E+03	5.5E+04	5.4E+03	1.1E+05	1.1E+04
106990	1,3-Butadiene		C	4.3E+01	2.0E+01	8.7E+01	3.9E+01	1.2E+02	5.6E+01	2.2E+02	9.8E+01	4.3E+02	2.0E+02
75150	Carbon disulfide		NC	3.5E+05	1.1E+05	7.0E+05	2.2E+05	1.0E+06	3.2E+05	1.8E+06	5.6E+05	3.5E+06	1.1E+06
56235	Carbon tetrachloride		C	8.1E+02	1.3E+02	1.6E+03	2.6E+02	2.3E+03	3.7E+02	4.1E+03	6.5E+02	8.1E+03	1.3E+03
57749	Chlordane		C	**	**	**	**	**	**	**	**	**	**
126998	2-Chloro-1,3-butadiene (chloroprene)		NC	3.5E+03	9.7E+02	7.0E+03	1.9E+03	1.0E+04	2.8E+03	1.8E+04	4.8E+03	3.5E+04	9.7E+03
108907	Chlorobenzene		NC	3.0E+04	6.5E+03	6.0E+04	1.3E+04	8.5E+04	1.8E+04	1.5E+05	3.2E+04	3.0E+05	6.5E+04
109693	1-Chlorobutane	X	NC	7.0E+05	1.8E+05	1.4E+06	3.7E+05	2.0E+06	5.3E+05	3.5E+06	9.2E+05	7.0E+06	1.8E+06
124481	Chlorodibromomethane	X	C	5.1E+02	6.0E+01	1.0E+03	1.2E+02	1.4E+03	1.7E+02	2.5E+03	3.0E+02	5.1E+03	6.0E+02
75456	Chlorodifluoromethane		NC	**	**	**	**	**	**	**	**	**	**
75003	Chloroethane (ethyl chloride)		NC	5.0E+06	1.9E+06	1.0E+07	3.8E+06	1.4E+07	5.4E+06	2.5E+07	9.5E+06	5.0E+07	1.9E+07
67663	Chloroform		C	5.3E+02	1.1E+02	1.1E+03	2.2E+02	1.5E+03	3.1E+02	2.6E+03	5.4E+02	5.3E+03	1.1E+03
95578	2-Chlorophenol	X	NC	8.8E+03	1.7E+03	1.8E+04	3.3E+03	2.5E+04	4.8E+03	4.4E+04	8.3E+03	8.8E+04	1.7E+04
75296	2-Chloropropane		NC	5.1E+04	1.6E+04	1.0E+05	3.2E+04	1.5E+05	4.5E+04	2.5E+05	7.9E+04	5.1E+05	1.6E+05
218019	Chrysene	X	C	**	**	**	**	**	**	**	**	**	**
156592	cis-1,2-Dichloroethylene	X	NC	1.8E+04	4.4E+03	3.5E+04	8.8E+03	5.0E+04	1.3E+04	8.8E+04	2.2E+04	1.8E+05	4.4E+04
123739	Crotonaldehyde (2-butenal)	X	C	2.2E+01	7.8E+00	4.5E+01	1.6E+01	6.4E+01	2.2E+01	1.1E+02	3.9E+01	2.2E+02	7.8E+01
98828	Cumene		NC	2.0E+05	4.1E+04	4.0E+05	8.1E+04	5.7E+05	1.2E+05	1.0E+06	2.0E+05	2.0E+06	4.1E+05
72559	DDE	X	C	**	**	**	**	**	**	**	**	**	**
132649	Dibenzofuran	X	NC	**	**	**	**	**	**	**	**	**	**
96128	1,2-Dibromo-3-chloropropane		NC	1.0E+02	1.0E+01	2.0E+02	2.1E+01	2.9E+02	3.0E+01	5.0E+02	5.2E+01	1.0E+03	1.0E+02
106934	1,2-Dibromoethane (ethylene dibromide)		C	5.5E+01	7.2E+00	1.1E+02	1.4E+01	1.6E+02	2.1E+01	2.8E+02	3.6E+01	5.5E+02	7.2E+01
541731	1,3-Dichlorobenzene	X	NC	5.3E+04	8.7E+03	1.1E+05	1.7E+04	1.5E+05	2.5E+04	2.6E+05	4.4E+04	5.3E+05	8.7E+04

DRAFT

Table 3b-SG: Question 5 Soil Gas Screening Levels for Scenario-Specific Vapor Attenuation Factors (a)

Risk = 1×10^{-5}

DRAFT

Target Soil Gas Concentrations for Different Attenuation Factors													
CAS No.	Chemical	Compounds with Provisional Toxicity Data Extrapolated From Oral Sources	Basis of Target Concentration C=cancer risk NC=noncancer risk	$\alpha = 2 \times 10^{-3}$		$\alpha = 1 \times 10^{-3}$		$\alpha = 7 \times 10^{-4}$		$\alpha = 4 \times 10^{-4}$		$\alpha = 2 \times 10^{-4}$	
				$C_{soil-gas}$ (ug/m ³)	(ppbv)	(ug/m ³)	(ppbv)	(ug/m ³)	(ppbv)	(ug/m ³)	(ppbv)	(ug/m ³)	(ppbv)
95501	1,2-Dichlorobenzene		NC	1.0E+05	1.7E+04	2.0E+05	3.3E+04	2.9E+05	4.8E+04	5.0E+05	8.3E+04	1.0E+06	1.7E+05
106467	1,4-Dichlorobenzene		NC	4.0E+05	6.7E+04	8.0E+05	1.3E+05	1.1E+06	1.9E+05	2.0E+06	3.3E+05	4.0E+06	6.7E+05
75718	Dichlorodifluoromethane		NC	1.0E+05	2.0E+04	2.0E+05	4.0E+04	2.9E+05	5.8E+04	5.0E+05	1.0E+05	1.0E+06	2.0E+05
75343	1,1-Dichloroethane		NC	2.5E+05	6.2E+04	5.0E+05	1.2E+05	7.1E+05	1.8E+05	1.3E+06	3.1E+05	2.5E+06	6.2E+05
107062	1,2-Dichloroethane		C	4.7E+02	1.2E+02	9.4E+02	2.3E+02	1.3E+03	3.3E+02	2.3E+03	5.8E+02	4.7E+03	1.2E+03
75354	1,1-Dichloroethylene		NC	1.0E+05	2.5E+04	2.0E+05	5.0E+04	2.9E+05	7.2E+04	5.0E+05	1.3E+05	1.0E+06	2.5E+05
78875	1,2-Dichloropropane		NC	2.0E+03	4.3E+02	4.0E+03	8.7E+02	5.7E+03	1.2E+03	1.0E+04	2.2E+03	2.0E+04	4.3E+03
542756	1,3-Dichloropropene		C	3.0E+03	6.7E+02	6.1E+03	1.3E+03	8.7E+03	1.9E+03	1.5E+04	3.4E+03	3.0E+04	6.7E+03
60571	Dieldrin		C	2.6E+00	1.7E-01	5.3E+00	3.4E-01	7.6E+00	4.9E-01	1.3E+01	8.5E-01	2.6E+01	1.7E+00
115297	Endosulfan	X	NC	**	**	**	**	**	**	**	**	**	**
108898	Epichlorohydrin		NC	5.0E+02	1.3E+02	1.0E+03	2.6E+02	1.4E+03	3.8E+02	2.5E+03	6.6E+02	5.0E+03	1.3E+03
60297	Ethyl ether	X	NC	3.5E+05	1.2E+05	7.0E+05	2.3E+05	1.0E+06	3.3E+05	1.8E+06	5.8E+05	3.5E+06	1.2E+06
141786	Ethylacetate	X	NC	1.6E+06	4.4E+05	3.2E+06	8.7E+05	4.5E+06	1.2E+06	7.9E+06	2.2E+06	1.6E+07	4.4E+06
100414	Ethylbenzene		C	1.1E+04	2.5E+03	2.2E+04	5.1E+03	3.2E+04	7.3E+03	5.5E+04	1.3E+04	1.1E+05	2.5E+04
75218	Ethylene oxide		C	1.2E+02	6.8E+01	2.4E+02	1.4E+02	3.5E+02	1.9E+02	6.1E+02	3.4E+02	1.2E+03	6.8E+02
97632	Ethylmethacrylate	X	NC	1.6E+05	3.4E+04	3.2E+05	6.8E+04	4.5E+05	9.6E+04	7.9E+05	1.7E+05	1.6E+06	3.4E+05
86737	Fluorene	X	NC	**	**	**	**	**	**	**	**	**	**
110009	Furan	X	NC	1.8E+03	6.3E+02	3.5E+03	1.3E+03	5.0E+03	1.8E+03	8.8E+03	3.1E+03	1.8E+04	6.3E+03
58899	gamma-HCH (Lindane)	X	C	3.3E+01	2.8E+00	6.6E+01	5.5E+00	9.4E+01	7.9E+00	1.6E+02	1.4E+01	3.3E+02	2.8E+01
76448	Heptachlor		C	9.4E+00	6.1E-01	1.9E+01	1.2E+00	2.7E+01	1.8E+00	4.7E+01	3.1E+00	9.4E+01	6.1E+00
87683	Hexachloro-1,3-butadiene		C	5.5E+02	5.2E+01	1.1E+03	1.0E+02	1.6E+03	1.5E+02	2.8E+03	2.6E+02	5.5E+03	5.2E+02
118741	Hexachlorobenzene		C	2.6E+01	2.3E+00	5.3E+01	4.5E+00	7.6E+01	6.5E+00	1.3E+02	1.1E+01	2.6E+02	2.3E+01
77474	Hexachlorocyclopentadiene		NC	1.0E+02	9.0E+00	2.0E+02	1.8E+01	2.9E+02	2.6E+01	5.0E+02	4.5E+01	1.0E+03	9.0E+01
67721	Hexachloroethane		C	3.0E+03	3.1E+02	6.1E+03	6.3E+02	8.7E+03	9.0E+02	1.5E+04	1.6E+03	3.0E+04	3.1E+03
110543	Hexane		NC	1.0E+05	2.8E+04	2.0E+05	5.7E+04	2.9E+05	8.1E+04	5.0E+05	1.4E+05	1.0E+06	2.8E+05
74908	Hydrogen cyanide		NC	1.5E+03	1.4E+03	3.0E+03	2.7E+03	4.3E+03	3.9E+03	7.5E+03	6.8E+03	1.5E+04	1.4E+04
78831	Isobutanol	X	NC	5.3E+05	1.7E+05	1.1E+06	3.5E+05	1.5E+06	5.0E+05	2.6E+06	8.7E+05	5.3E+06	1.7E+06
7439976	Mercury (elemental)		NC	1.5E+02	1.8E+01	3.0E+02	3.7E+01	4.3E+02	5.2E+01	7.5E+02	9.1E+01	1.5E+03	1.8E+02
126987	Methacrylonitrile		NC	3.5E+02	1.3E+02	7.0E+02	2.6E+02	1.0E+03	3.6E+02	1.8E+03	6.4E+02	3.5E+03	1.3E+03
72435	Methoxychlor	X	NC	**	**	**	**	**	**	**	**	**	**
79209	Methyl acetate	X	NC	1.8E+06	5.8E+05	3.5E+06	1.2E+06	5.0E+06	1.7E+06	8.8E+06	2.9E+06	**	**
96333	Methyl acrylate	X	NC	5.3E+04	1.5E+04	1.1E+05	3.0E+04	1.5E+05	4.3E+04	2.6E+05	7.5E+04	5.3E+05	1.5E+05
74839	Methyl bromide		NC	2.5E+03	6.4E+02	5.0E+03	1.3E+03	7.1E+03	1.8E+03	1.3E+04	3.2E+03	2.5E+04	6.4E+03
74873	Methyl chloride (chloromethane)		C	1.2E+04	5.9E+03	2.4E+04	1.2E+04	3.5E+04	1.7E+04	6.1E+04	2.9E+04	1.2E+05	5.9E+04
108872	Methylcyclohexane		NC	1.5E+06	3.7E+05	3.0E+06	7.5E+05	4.3E+06	1.1E+06	7.5E+06	1.9E+06	1.5E+07	3.7E+06
74953	Methylene bromide	X	NC	1.8E+04	2.5E+03	3.5E+04	4.9E+03	5.0E+04	7.0E+03	8.8E+04	1.2E+04	1.8E+05	2.5E+04
75092	Methylene chloride		C	2.6E+04	7.5E+03	5.2E+04	1.5E+04	7.4E+04	2.1E+04	1.3E+05	3.7E+04	2.6E+05	7.5E+04
78933	Methylethylketone (2-butanone)		NC	5.0E+05	1.7E+05	1.0E+06	3.4E+05	1.4E+06	4.8E+05	2.5E+06	8.5E+05	5.0E+06	1.7E+06
108101	Methylisobutylketone		NC	4.0E+04	9.8E+03	8.0E+04	2.0E+04	1.1E+05	2.8E+04	2.0E+05	4.9E+04	4.0E+05	9.8E+04
80626	Methylmethacrylate		NC	3.5E+05	8.6E+04	7.0E+05	1.7E+05	1.0E+06	2.4E+05	1.8E+06	4.3E+05	3.5E+06	8.6E+05
91576	2-Methylnaphthalene	X	NC	3.5E+04	6.0E+03	7.0E+04	1.2E+04	1.0E+05	1.7E+04	1.8E+05	3.0E+04	3.5E+05	6.0E+04
1634044	MTBE		NC	1.5E+06	4.2E+05	3.0E+06	8.3E+05	4.3E+06	1.2E+06	7.5E+06	2.1E+06	1.5E+07	4.2E+06

DRAFT

Table 3b-SG: Question 5 Soil Gas Screening Levels for Scenario-Specific Vapor Attenuation Factors (α)

DRAFT

Risk = 1×10^{-5}

Target Soil Gas Concentrations for Different Attenuation Factors													
CAS No.	Chemical	Compounds with Provisional Toxicity Data Extrapolated From Oral Sources	Basis of Target Concentration C=cancer risk NC=noncancer risk	$\alpha = 2 \times 10^{-3}$		$\alpha = 1 \times 10^{-3}$		$\alpha = 7 \times 10^{-4}$		$\alpha = 4 \times 10^{-4}$		$\alpha = 2 \times 10^{-4}$	
				$C_{soil-gas}$ (ug/m ³)	(ppbv)	(ug/m ³)	(ppbv)	(ug/m ³)	(ppbv)	(ug/m ³)	(ppbv)	(ug/m ³)	(ppbv)
108383	m-Xylene	X	NC	3.5E+06	8.1E+05	7.0E+06	1.6E+06	1.0E+07	2.3E+06	1.8E+07	4.0E+06	3.5E+07	8.1E+06
91203	Naphthalene		NC	1.5E+03	2.9E+02	3.0E+03	5.7E+02	4.3E+03	8.2E+02	7.5E+03	1.4E+03	1.5E+04	2.9E+03
104518	n-Butylbenzene	X	NC	7.0E+04	1.3E+04	1.4E+05	2.6E+04	2.0E+05	3.6E+04	3.5E+05	6.4E+04	7.0E+05	1.3E+05
98953	Nitrobenzene		NC	1.0E+03	2.0E+02	2.0E+03	4.0E+02	2.9E+03	5.7E+02	5.0E+03	9.9E+02	1.0E+04	2.0E+03
79469	2-Nitropropane		C	4.5E+00	1.2E+00	9.0E+00	2.5E+00	1.3E+01	3.5E+00	2.3E+01	6.2E+00	4.5E+01	1.2E+01
924163	N-Nitroso-di-n-butylamine		C	7.6E+00	1.2E+00	1.5E+01	2.4E+00	2.2E+01	3.4E+00	3.8E+01	5.9E+00	7.6E+01	1.2E+01
103651	n-Propylbenzene	X	NC	7.0E+04	1.4E+04	1.4E+05	2.8E+04	2.0E+05	4.1E+04	3.5E+05	7.1E+04	7.0E+05	1.4E+05
88722	o-Nitrotoluene	X	NC	1.8E+04	3.1E+03	3.5E+04	6.2E+03	5.0E+04	8.9E+03	8.8E+04	1.6E+04	1.8E+05	3.1E+04
95476	o-Xylene	X	NC	3.5E+06	8.1E+05	7.0E+06	1.6E+06	1.0E+07	2.3E+06	1.8E+07	4.0E+06	3.5E+07	8.1E+06
106423	p-Xylene	X	NC	3.5E+06	8.1E+05	7.0E+06	1.6E+06	1.0E+07	2.3E+06	1.8E+07	4.0E+06	3.5E+07	8.1E+06
129000	Pyrene	X	NC	**	**	**	**	**	**	**	**	**	**
135988	sec-Butylbenzene	X	NC	7.0E+04	1.3E+04	1.4E+05	2.6E+04	2.0E+05	3.6E+04	3.5E+05	6.4E+04	7.0E+05	1.3E+05
100425	Styrene		NC	5.0E+05	1.2E+05	1.0E+06	2.3E+05	1.4E+06	3.4E+05	2.5E+06	5.9E+05	5.0E+06	1.2E+06
98066	tert-Butylbenzene	X	NC	7.0E+04	1.3E+04	1.4E+05	2.6E+04	2.0E+05	3.6E+04	3.5E+05	6.4E+04	7.0E+05	1.3E+05
630206	1,1,1,2-Tetrachloroethane		C	1.6E+03	2.4E+02	3.3E+03	4.8E+02	4.7E+03	6.8E+02	8.2E+03	1.2E+03	1.6E+04	2.4E+03
79345	1,1,2,2-Tetrachloroethane		C	2.1E+02	3.1E+01	4.2E+02	6.1E+01	6.0E+02	8.7E+01	1.0E+03	1.5E+02	2.1E+03	3.1E+02
127184	Tetrachloroethylene		C	4.1E+03	6.0E+02	8.1E+03	1.2E+03	1.2E+04	1.7E+03	2.0E+04	3.0E+03	4.1E+04	6.0E+03
108883	Toluene		NC	2.0E+05	5.3E+04	4.0E+05	1.1E+05	5.7E+05	1.5E+05	1.0E+06	2.7E+05	2.0E+06	5.3E+05
156605	trans-1,2-Dichloroethylene	X	NC	3.5E+04	8.8E+03	7.0E+04	1.8E+04	1.0E+05	2.5E+04	1.8E+05	4.4E+04	3.5E+05	8.8E+04
76131	1,1,2-Trichloro-1,2,2-trifluoroethane		NC	1.5E+07	2.0E+06	3.0E+07	3.9E+06	4.3E+07	5.6E+06	7.5E+07	9.8E+06	1.5E+08	2.0E+07
120821	1,2,4-Trichlorobenzene		NC	1.0E+05	1.3E+04	2.0E+05	2.7E+04	2.9E+05	3.8E+04	5.0E+05	6.7E+04	1.0E+06	1.3E+05
79005	1,1,2-Trichloroethane		C	7.6E+02	1.4E+02	1.5E+03	2.8E+02	2.2E+03	4.0E+02	3.8E+03	7.0E+02	7.6E+03	1.4E+03
71556	1,1,1-Trichloroethane		NC	1.1E+06	2.0E+05	2.2E+06	4.0E+05	3.1E+06	5.8E+05	5.5E+06	1.0E+06	1.1E+07	2.0E+06
79016	Trichloroethylene ^{††}	X	C	1.1E+02	2.1E+01	2.2E+02	4.1E+01	3.2E+02	5.9E+01	5.5E+02	1.0E+02	1.1E+03	2.1E+02
75694	Trichlorofluoromethane		NC	3.5E+05	6.2E+04	7.0E+05	1.2E+05	1.0E+06	1.8E+05	1.8E+06	3.1E+05	3.5E+06	6.2E+05
96184	1,2,3-Trichloropropane		NC	2.5E+03	4.1E+02	4.9E+03	8.1E+02	7.0E+03	1.2E+03	1.2E+04	2.0E+03	2.5E+04	4.1E+03
95636	1,2,4-Trimethylbenzene		NC	3.0E+03	6.1E+02	6.0E+03	1.2E+03	8.5E+03	1.7E+03	1.5E+04	3.0E+03	3.0E+04	6.1E+03
108678	1,3,5-Trimethylbenzene		NC	3.0E+03	6.1E+02	6.0E+03	1.2E+03	8.5E+03	1.7E+03	1.5E+04	3.0E+03	3.0E+04	6.1E+03
108054	Vinyl acetate		NC	1.0E+05	2.8E+04	2.0E+05	5.7E+04	2.9E+05	8.1E+04	5.0E+05	1.4E+05	1.0E+06	2.8E+05
75014	Vinyl chloride (chloroethene)		C	1.4E+03	5.4E+02	2.8E+03	1.1E+03	4.0E+03	1.5E+03	6.9E+03	2.7E+03	1.4E+04	5.4E+03

* Health-based target breathing concentration exceeds maximum possible chemical vapor concentration (pathway incomplete)

** Target soil gas concentration exceeds maximum possible vapor concentration at this soil gas to indoor air attenuation factor (pathway incomplete)

†† The target concentration for trichloroethylene is based on the upper bound cancer slope factor identified in EPA's draft risk assessment for trichloroethylene (US EPA, 2001). The slope factor is based on state-of-the-art methodology, however the TCE assessment is still undergoing review. As a result, the slope factor and the target concentration values for TCE may be revised further. (See Appendix D.)

DRAFT

Table 3c-SG: Question 5 Soil Gas Screening Levels for Scenario-Specific Vapor Attenuation Factors (α)

Risk = 1×10^{-6}

DRAFT

Target Soil Gas Concentrations for Different Attenuation Factors													
CAS No.	Chemical	Compounds with Provisional Toxicity Data Extrapolated From Oral Sources	Basis of Target Concentration C=cancer risk NC=noncancer risk	$\alpha = 2 \times 10^{-3}$		$\alpha = 1 \times 10^{-3}$		$\alpha = 7 \times 10^{-4}$		$\alpha = 4 \times 10^{-4}$		$\alpha = 2 \times 10^{-4}$	
				$C_{soil-gas}$ (ug/m ³)	(ppbv)	(ug/m ³)	(ppbv)	(ug/m ³)	(ppbv)	(ug/m ³)	(ppbv)	(ug/m ³)	(ppbv)
83329	Acenaphthene	X	NC	**	**	**	**	**	**	**	**	**	**
75070	Acetaldehyde		C	5.5E+02	3.1E+02	1.1E+03	6.1E+02	1.6E+03	8.8E+02	2.8E+03	1.5E+03	5.5E+03	3.1E+03
67641	Acetone	X	NC	1.8E+05	7.4E+04	3.5E+05	1.5E+05	5.0E+05	2.1E+05	8.8E+05	3.7E+05	1.8E+06	7.4E+05
75058	Acetonitrile		NC	3.0E+04	1.8E+04	6.0E+04	3.6E+04	8.6E+04	5.1E+04	1.5E+05	8.9E+04	3.0E+05	1.8E+05
98862	Acetophenone	X	NC	1.8E+05	3.6E+04	3.5E+05	7.1E+04	5.0E+05	1.0E+05	8.8E+05	1.8E+05	1.8E+06	3.6E+05
107028	Acrolein		NC	1.0E+01	4.4E+00	2.0E+01	8.7E+00	2.9E+01	1.2E+01	5.0E+01	2.2E+01	1.0E+02	4.4E+01
107131	Acrylonitrile		C	1.8E+01	8.3E+00	3.6E+01	1.7E+01	5.1E+01	2.4E+01	8.9E+01	4.1E+01	1.8E+02	8.3E+01
309002	Aldrin		C	2.5E-01	1.7E-02	5.0E-01	3.3E-02	7.1E-01	4.8E-02	1.2E+00	8.3E-02	2.5E+00	1.7E-01
319846	alpha-HCH (alpha-BHC)		C	6.8E-01	5.7E-02	1.4E+00	1.1E-01	1.9E+00	1.6E-01	3.4E+00	2.8E-01	6.8E+00	5.7E-01
100527	Benzaldehyde	X	NC	1.8E+05	4.0E+04	3.5E+05	8.1E+04	5.0E+05	1.2E+05	8.8E+05	2.0E+05	1.8E+06	4.0E+05
71432	Benzene		C	1.6E+02	4.9E+01	3.1E+02	9.8E+01	4.5E+02	1.4E+02	7.8E+02	2.4E+02	1.6E+03	4.9E+02
205992	Benzo(b)fluoranthene	X	C	5.8E+00	5.6E-01	**	**	**	**	**	**	**	**
100447	Benzylchloride	X	C	2.5E+01	4.8E+00	5.0E+01	9.7E+00	7.2E+01	1.4E+01	1.3E+02	2.4E+01	2.5E+02	4.8E+01
91587	beta-Chloronaphthalene	X	NC	1.4E+05	2.1E+04	**	**	**	**	**	**	**	**
92524	Biphenyl	X	NC	8.8E+04	1.4E+04	**	**	**	**	**	**	**	**
114444	Bis(2-chloroethoxy)ether		C	3.7E+00	6.3E-01	7.4E+00	1.3E+00	1.1E+01	1.8E+00	1.8E+01	3.2E+00	3.7E+01	6.3E+00
108601	Bis(2-chloroisopropyl)ether		C	1.2E+02	1.7E+01	2.4E+02	3.5E+01	3.5E+02	5.0E+01	6.1E+02	8.7E+01	1.2E+03	1.7E+02
542881	Bis(chloromethyl)ether		C	2.0E-02	4.2E-03	3.9E-02	8.4E-03	5.6E-02	1.2E-02	9.8E-02	2.1E-02	2.0E-01	4.2E-02
75274	Bromodichloromethane	X	C	6.9E+01	1.0E+01	1.4E+02	2.1E+01	2.0E+02	2.9E+01	3.4E+02	5.1E+01	6.9E+02	1.0E+02
75252	Bromoform		C	1.1E+03	1.1E+02	2.2E+03	2.1E+02	3.2E+03	3.1E+02	5.5E+03	5.4E+02	1.1E+04	1.1E+03
106990	1,3-Butadiene		C	4.3E+00	2.0E+00	8.7E+00	3.9E+00	1.2E+01	5.6E+00	2.2E+01	9.8E+00	4.3E+01	2.0E+01
75150	Carbon disulfide		NC	3.5E+05	1.1E+05	7.0E+05	2.2E+05	1.0E+06	3.2E+05	1.8E+06	5.6E+05	3.5E+06	1.1E+06
56235	Carbon tetrachloride		C	8.1E+01	1.3E+01	1.6E+02	2.6E+01	2.3E+02	3.7E+01	4.1E+02	6.5E+01	8.1E+02	1.3E+02
57749	Chlordane		C	1.2E+01	7.3E-01	2.4E+01	1.5E+00	3.5E+01	2.1E+00	6.1E+01	3.6E+00	**	**
126998	2-Chloro-1,3-butadiene (chloroprene)		NC	3.5E+03	9.7E+02	7.0E+03	1.9E+03	1.0E+04	2.8E+03	1.8E+04	4.8E+03	3.5E+04	9.7E+03
108907	Chlorobenzene		NC	3.0E+04	6.5E+03	6.0E+04	1.3E+04	8.5E+04	1.8E+04	1.5E+05	3.2E+04	3.0E+05	6.5E+04
109693	1-Chlorobutane	X	NC	7.0E+05	1.8E+05	1.4E+06	3.7E+05	2.0E+06	5.3E+05	3.5E+06	9.2E+05	7.0E+06	1.8E+06
124481	Chlorodibromomethane	X	C	5.1E+01	6.0E+00	1.0E+02	1.2E+01	1.4E+02	1.7E+01	2.5E+02	3.0E+01	5.1E+02	6.0E+01
75456	Chlorodifluoromethane		NC	**	**	**	**	**	**	**	**	**	**
75003	Chloroethane (ethyl chloride)		NC	5.0E+06	1.9E+06	1.0E+07	3.8E+06	1.4E+07	5.4E+06	2.5E+07	9.5E+06	5.0E+07	1.9E+07
67663	Chloroform		C	5.3E+01	1.1E+01	1.1E+02	2.2E+01	1.5E+02	3.1E+01	2.6E+02	5.4E+01	5.3E+02	1.1E+02
95578	2-Chlorophenol	X	NC	8.8E+03	1.7E+03	1.8E+04	3.3E+03	2.5E+04	4.8E+03	4.4E+04	8.3E+03	8.8E+04	1.7E+04
75296	2-Chloropropane		NC	5.1E+04	1.6E+04	1.0E+05	3.2E+04	1.5E+05	4.5E+04	2.5E+05	7.9E+04	5.1E+05	1.6E+05
218019	Chrysene	X	C	**	**	**	**	**	**	**	**	**	**
156592	cis-1,2-Dichloroethylene	X	NC	1.8E+04	4.4E+03	3.5E+04	8.8E+03	5.0E+04	1.3E+04	8.8E+04	2.2E+04	1.8E+05	4.4E+04
123739	Crotonaldehyde (2-butenal)	X	C	2.2E+00	7.8E-01	4.5E+00	1.6E+00	6.4E+00	2.2E+00	1.1E+01	3.9E+00	2.2E+01	7.8E+00
98828	Cumene		NC	2.0E+05	4.1E+04	4.0E+05	8.1E+04	5.7E+05	1.2E+05	1.0E+06	2.0E+05	2.0E+06	4.1E+05
72559	DDE	X	C	1.3E+01	9.6E-01	2.5E+01	1.9E+00	3.6E+01	2.8E+00	6.3E+01	4.8E+00	**	**
132649	Dibenzofuran	X	NC	**	**	**	**	**	**	**	**	**	**
96128	1,2-Dibromo-3-chloropropane		NC	1.0E+02	1.0E+01	2.0E+02	2.1E+01	2.9E+02	3.0E+01	5.0E+02	5.2E+01	1.0E+03	1.0E+02
106934	1,2-Dibromoethane (ethylene dibromide)		C	5.5E+00	7.2E-01	1.1E+01	1.4E+00	1.6E+01	2.1E+00	2.8E+01	3.6E+00	5.5E+01	7.2E+00
541731	1,3-Dichlorobenzene	X	NC	5.3E+04	8.7E+03	1.1E+05	1.7E+04	1.5E+05	2.5E+04	2.6E+05	4.4E+04	5.3E+05	8.7E+04

DRAFT

Table 3c-SG: Question 5 Soil Gas Screening Levels for Scenario-Specific Vapor Attenuation Factors (α)

Risk = 1×10^{-6}

DRAFT

Target Soil Gas Concentrations for Different Attenuation Factors													
CAS No.	Chemical	Compounds with Provisional Toxicity Data Extrapolated From Oral Sources	Basis of Target Concentration C=cancer risk NC=noncancer risk	$\alpha = 2 \times 10^{-3}$		$\alpha = 1 \times 10^{-3}$		$\alpha = 7 \times 10^{-4}$		$\alpha = 4 \times 10^{-4}$		$\alpha = 2 \times 10^{-4}$	
				$C_{soil-gas}$ (ug/m ³)	(ppbv)	(ug/m ³)	(ppbv)	(ug/m ³)	(ppbv)	(ug/m ³)	(ppbv)	(ug/m ³)	(ppbv)
95501	1,2-Dichlorobenzene		NC	1.0E+05	1.7E+04	2.0E+05	3.3E+04	2.9E+05	4.8E+04	5.0E+05	8.3E+04	1.0E+06	1.7E+05
106467	1,4-Dichlorobenzene		NC	4.0E+05	6.7E+04	8.0E+05	1.3E+05	1.1E+06	1.9E+05	2.0E+06	3.3E+05	4.0E+06	6.7E+05
75718	Dichlorodifluoromethane		NC	1.0E+05	2.0E+04	2.0E+05	4.0E+04	2.9E+05	5.8E+04	5.0E+05	1.0E+05	1.0E+06	2.0E+05
75343	1,1-Dichloroethane		NC	2.5E+05	6.2E+04	5.0E+05	1.2E+05	7.1E+05	1.8E+05	1.3E+06	3.1E+05	2.5E+06	6.2E+05
107062	1,2-Dichloroethane		C	4.7E+01	1.2E+01	9.4E+01	2.3E+01	1.3E+02	3.3E+01	2.3E+02	5.8E+01	4.7E+02	1.2E+02
75354	1,1-Dichloroethylene		NC	1.0E+05	2.5E+04	2.0E+05	5.0E+04	2.9E+05	7.2E+04	5.0E+05	1.3E+05	1.0E+06	2.5E+05
78875	1,2-Dichloropropane		NC	2.0E+03	4.3E+02	4.0E+03	8.7E+02	5.7E+03	1.2E+03	1.0E+04	2.2E+03	2.0E+04	4.3E+03
542756	1,3-Dichloropropene		C	3.0E+02	6.7E+01	6.1E+02	1.3E+02	8.7E+02	1.9E+02	1.5E+03	3.4E+02	3.0E+03	6.7E+02
60571	Dieldrin		C	2.6E-01	1.7E-02	5.3E-01	3.4E-02	7.6E-01	4.9E-02	1.3E+00	8.5E-02	2.6E+00	1.7E-01
115297	Endosulfan	X	NC	**	**	**	**	**	**	**	**	**	**
108898	Epichlorohydrin		NC	5.0E+02	1.3E+02	1.0E+03	2.6E+02	1.4E+03	3.8E+02	2.5E+03	6.6E+02	5.0E+03	1.3E+03
60297	Ethyl ether	X	NC	3.5E+05	1.2E+05	7.0E+05	2.3E+05	1.0E+06	3.3E+05	1.8E+06	5.8E+05	3.5E+06	1.2E+06
141786	Ethylacetate	X	NC	1.6E+06	4.4E+05	3.2E+06	8.7E+05	4.5E+06	1.2E+06	7.9E+06	2.2E+06	1.6E+07	4.4E+06
100414	Ethylbenzene		C	1.1E+03	2.5E+02	2.2E+03	5.1E+02	3.2E+03	7.3E+02	5.5E+03	1.3E+03	1.1E+04	2.5E+03
75218	Ethylene oxide		C	1.2E+01	6.8E+00	2.4E+01	1.4E+01	3.5E+01	1.9E+01	6.1E+01	3.4E+01	1.2E+02	6.8E+01
97632	Ethylmethacrylate	X	NC	1.6E+05	3.4E+04	3.2E+05	6.8E+04	4.5E+05	9.6E+04	7.9E+05	1.7E+05	1.6E+06	3.4E+05
86737	Fluorene	X	NC	**	**	**	**	**	**	**	**	**	**
110009	Furan	X	NC	1.8E+03	6.3E+02	3.5E+03	1.3E+03	5.0E+03	1.8E+03	8.8E+03	3.1E+03	1.8E+04	6.3E+03
58899	gamma-HCH (Lindane)	X	C	3.3E+00	2.8E-01	6.6E+00	5.5E-01	9.4E+00	7.9E-01	1.6E+01	1.4E+00	3.3E+01	2.8E+00
76448	Heptachlor		C	9.4E-01	6.1E-02	1.9E+00	1.2E-01	2.7E+00	1.8E-01	4.7E+00	3.1E-01	9.4E+00	6.1E-01
87683	Hexachloro-1,3-butadiene		C	5.5E+01	5.2E+00	1.1E+02	1.0E+01	1.6E+02	1.5E+01	2.8E+02	2.6E+01	5.5E+02	5.2E+01
118741	Hexachlorobenzene		C	2.6E+00	2.3E-01	5.3E+00	4.5E-01	7.6E+00	6.5E-01	1.3E+01	1.1E+00	2.6E+01	2.3E+00
77474	Hexachlorocyclopentadiene		NC	1.0E+02	9.0E+00	2.0E+02	1.8E+01	2.9E+02	2.6E+01	5.0E+02	4.5E+01	1.0E+03	9.0E+01
67721	Hexachloroethane		C	3.0E+02	3.1E+01	6.1E+02	6.3E+01	8.7E+02	9.0E+01	1.5E+03	1.6E+02	3.0E+03	3.1E+02
110543	Hexane		NC	1.0E+05	2.8E+04	2.0E+05	5.7E+04	2.9E+05	8.1E+04	5.0E+05	1.4E+05	1.0E+06	2.8E+05
74908	Hydrogen cyanide		NC	1.5E+03	1.4E+03	3.0E+03	2.7E+03	4.3E+03	3.9E+03	7.5E+03	6.8E+03	1.5E+04	1.4E+04
78831	Isobutanol	X	NC	5.3E+05	1.7E+05	1.1E+06	3.5E+05	1.5E+06	5.0E+05	2.6E+06	8.7E+05	5.3E+06	1.7E+06
7439976	Mercury (elemental)		NC	1.5E+02	1.8E+01	3.0E+02	3.7E+01	4.3E+02	5.2E+01	7.5E+02	9.1E+01	1.5E+03	1.8E+02
126987	Methacrylonitrile		NC	3.5E+02	1.3E+02	7.0E+02	2.6E+02	1.0E+03	3.6E+02	1.8E+03	6.4E+02	3.5E+03	1.3E+03
72435	Methoxychlor	X	NC	**	**	**	**	**	**	**	**	**	**
79209	Methyl acetate	X	NC	1.8E+06	5.8E+05	3.5E+06	1.2E+06	5.0E+06	1.7E+06	8.8E+06	2.9E+06	**	**
96333	Methyl acrylate	X	NC	5.3E+04	1.5E+04	1.1E+05	3.0E+04	1.5E+05	4.3E+04	2.6E+05	7.5E+04	5.3E+05	1.5E+05
74839	Methyl bromide		NC	2.5E+03	6.4E+02	5.0E+03	1.3E+03	7.1E+03	1.8E+03	1.3E+04	3.2E+03	2.5E+04	6.4E+03
74873	Methyl chloride (chloromethane)		C	1.2E+03	5.9E+02	2.4E+03	1.2E+03	3.5E+03	1.7E+03	6.1E+03	2.9E+03	1.2E+04	5.9E+03
108872	Methylcyclohexane		NC	1.5E+06	3.7E+05	3.0E+06	7.5E+05	4.3E+06	1.1E+06	7.5E+06	1.9E+06	1.5E+07	3.7E+06
74953	Methylene bromide	X	NC	1.8E+04	2.5E+03	3.5E+04	4.9E+03	5.0E+04	7.0E+03	8.8E+04	1.2E+04	1.8E+05	2.5E+04
75092	Methylene chloride		C	2.6E+03	7.5E+02	5.2E+03	1.5E+03	7.4E+03	2.1E+03	1.3E+04	3.7E+03	2.6E+04	7.5E+03
78933	Methylethylketone (2-butanone)		NC	5.0E+05	1.7E+05	1.0E+06	3.4E+05	1.4E+06	4.8E+05	2.5E+06	8.5E+05	5.0E+06	1.7E+06
108101	Methylisobutylketone		NC	4.0E+04	9.8E+03	8.0E+04	2.0E+04	1.1E+05	2.8E+04	2.0E+05	4.9E+04	4.0E+05	9.8E+04
80626	Methylmethacrylate		NC	3.5E+05	8.6E+04	7.0E+05	1.7E+05	1.0E+06	2.4E+05	1.8E+06	4.3E+05	3.5E+06	8.6E+05
91576	2-Methylnaphthalene	X	NC	3.5E+04	6.0E+03	7.0E+04	1.2E+04	1.0E+05	1.7E+04	1.8E+05	3.0E+04	3.5E+05	6.0E+04
1634044	MTBE		NC	1.5E+06	4.2E+05	3.0E+06	8.3E+05	4.3E+06	1.2E+06	7.5E+06	2.1E+06	1.5E+07	4.2E+06

DRAFT

Table 3c-SG: Question 5 Soil Gas Screening Levels for Scenario-Specific Vapor Attenuation Factors (α)

DRAFT

Risk = 1×10^{-6}

Target Soil Gas Concentrations for Different Attenuation Factors													
CAS No.	Chemical	Compounds with Provisional Toxicity Data Extrapolated From Oral Sources	Basis of Target Concentration C=cancer risk NC=noncancer risk	$\alpha = 2 \times 10^{-3}$		$\alpha = 1 \times 10^{-3}$		$\alpha = 7 \times 10^{-4}$		$\alpha = 4 \times 10^{-4}$		$\alpha = 2 \times 10^{-4}$	
				$C_{soil-gas}$ (ug/m ³)	(ppbv)	(ug/m ³)	(ppbv)	(ug/m ³)	(ppbv)	(ug/m ³)	(ppbv)	(ug/m ³)	(ppbv)
108383	m-Xylene	X	NC	3.5E+06	8.1E+05	7.0E+06	1.6E+06	1.0E+07	2.3E+06	1.8E+07	4.0E+06	3.5E+07	8.1E+06
91203	Naphthalene		NC	1.5E+03	2.9E+02	3.0E+03	5.7E+02	4.3E+03	8.2E+02	7.5E+03	1.4E+03	1.5E+04	2.9E+03
104518	n-Butylbenzene	X	NC	7.0E+04	1.3E+04	1.4E+05	2.6E+04	2.0E+05	3.6E+04	3.5E+05	6.4E+04	7.0E+05	1.3E+05
98953	Nitrobenzene		NC	1.0E+03	2.0E+02	2.0E+03	4.0E+02	2.9E+03	5.7E+02	5.0E+03	9.9E+02	1.0E+04	2.0E+03
79469	2-Nitropropane		C	4.5E-01	1.2E-01	9.0E-01	2.5E-01	1.3E+00	3.5E-01	2.3E+00	6.2E-01	4.5E+00	1.2E+00
924163	N-Nitroso-di-n-butylamine		C	7.6E-01	1.2E-01	1.5E+00	2.4E-01	2.2E+00	3.4E-01	3.8E+00	5.9E-01	7.6E+00	1.2E+00
103651	n-Propylbenzene	X	NC	7.0E+04	1.4E+04	1.4E+05	2.8E+04	2.0E+05	4.1E+04	3.5E+05	7.1E+04	7.0E+05	1.4E+05
88722	o-Nitrotoluene	X	NC	1.8E+04	3.1E+03	3.5E+04	6.2E+03	5.0E+04	8.9E+03	8.8E+04	1.6E+04	1.8E+05	3.1E+04
95476	o-Xylene	X	NC	3.5E+06	8.1E+05	7.0E+06	1.6E+06	1.0E+07	2.3E+06	1.8E+07	4.0E+06	3.5E+07	8.1E+06
106423	p-Xylene	X	NC	3.5E+06	8.1E+05	7.0E+06	1.6E+06	1.0E+07	2.3E+06	1.8E+07	4.0E+06	3.5E+07	8.1E+06
129000	Pyrene	X	NC	**	**	**	**	**	**	**	**	**	**
135988	sec-Butylbenzene	X	NC	7.0E+04	1.3E+04	1.4E+05	2.6E+04	2.0E+05	3.6E+04	3.5E+05	6.4E+04	7.0E+05	1.3E+05
100425	Styrene		NC	5.0E+05	1.2E+05	1.0E+06	2.3E+05	1.4E+06	3.4E+05	2.5E+06	5.9E+05	5.0E+06	1.2E+06
98066	tert-Butylbenzene	X	NC	7.0E+04	1.3E+04	1.4E+05	2.6E+04	2.0E+05	3.6E+04	3.5E+05	6.4E+04	7.0E+05	1.3E+05
630206	1,1,1,2-Tetrachloroethane		C	1.6E+02	2.4E+01	3.3E+02	4.8E+01	4.7E+02	6.8E+01	8.2E+02	1.2E+02	1.6E+03	2.4E+02
79345	1,1,2,2-Tetrachloroethane		C	2.1E+01	3.1E+00	4.2E+01	6.1E+00	6.0E+01	8.7E+00	1.0E+02	1.5E+01	2.1E+02	3.1E+01
127184	Tetrachloroethylene		C	4.1E+02	6.0E+01	8.1E+02	1.2E+02	1.2E+03	1.7E+02	2.0E+03	3.0E+02	4.1E+03	6.0E+02
108883	Toluene		NC	2.0E+05	5.3E+04	4.0E+05	1.1E+05	5.7E+05	1.5E+05	1.0E+06	2.7E+05	2.0E+06	5.3E+05
156605	trans-1,2-Dichloroethylene	X	NC	3.5E+04	8.8E+03	7.0E+04	1.8E+04	1.0E+05	2.5E+04	1.8E+05	4.4E+04	3.5E+05	8.8E+04
76131	1,1,2-Trichloro-1,2,2-trifluoroethane		NC	1.5E+07	2.0E+06	3.0E+07	3.9E+06	4.3E+07	5.6E+06	7.5E+07	9.8E+06	1.5E+08	2.0E+07
120821	1,2,4-Trichlorobenzene		NC	1.0E+05	1.3E+04	2.0E+05	2.7E+04	2.9E+05	3.8E+04	5.0E+05	6.7E+04	1.0E+06	1.3E+05
79005	1,1,2-Trichloroethane		C	7.6E+01	1.4E+01	1.5E+02	2.8E+01	2.2E+02	4.0E+01	3.8E+02	7.0E+01	7.6E+02	1.4E+02
71556	1,1,1-Trichloroethane		NC	1.1E+06	2.0E+05	2.2E+06	4.0E+05	3.1E+06	5.8E+05	5.5E+06	1.0E+06	1.1E+07	2.0E+06
79016	Trichloroethylene ^{††}	X	C	1.1E+01	2.1E+00	2.2E+01	4.1E+00	3.2E+01	5.9E+00	5.5E+01	1.0E+01	1.1E+02	2.1E+01
75694	Trichlorofluoromethane		NC	3.5E+05	6.2E+04	7.0E+05	1.2E+05	1.0E+06	1.8E+05	1.8E+06	3.1E+05	3.5E+06	6.2E+05
96184	1,2,3-Trichloropropane		NC	2.5E+03	4.1E+02	4.9E+03	8.1E+02	7.0E+03	1.2E+03	1.2E+04	2.0E+03	2.5E+04	4.1E+03
95636	1,2,4-Trimethylbenzene		NC	3.0E+03	6.1E+02	6.0E+03	1.2E+03	8.5E+03	1.7E+03	1.5E+04	3.0E+03	3.0E+04	6.1E+03
108678	1,3,5-Trimethylbenzene		NC	3.0E+03	6.1E+02	6.0E+03	1.2E+03	8.5E+03	1.7E+03	1.5E+04	3.0E+03	3.0E+04	6.1E+03
108054	Vinyl acetate		NC	1.0E+05	2.8E+04	2.0E+05	5.7E+04	2.9E+05	8.1E+04	5.0E+05	1.4E+05	1.0E+06	2.8E+05
75014	Vinyl chloride (chloroethene)		C	1.4E+02	5.4E+01	2.8E+02	1.1E+02	4.0E+02	1.5E+02	6.9E+02	2.7E+02	1.4E+03	5.4E+02

* Health-based target breathing concentration exceeds maximum possible chemical vapor concentration (pathway incomplete)

** Target soil gas concentration exceeds maximum possible vapor concentration at this soil gas to indoor air attenuation factor (pathway incomplete)

†† The target concentration for trichloroethylene is based on the upper bound cancer slope factor identified in EPA's draft risk assessment for trichloroethylene (US EPA, 2001). The slope factor is based on state-of-the-art methodology, however the TCE assessment is still undergoing review. As a result, the slope factor and the target concentration values for TCE may be revised further. (See Appendix D.)

DRAFT

Table 3a - GW: Question 5 Groundwater Screening Levels for Scenario-Specific Vapor Attenuation Factors (α)

Risk = 1×10^{-4}

CAS No.	Chemical	Compounds with Provisional Toxicity Data Extrapolated From Oral Sources	Basis of Target Concentration C=cancer risk NC=noncancer risk	Target Groundwater Concentrations at Different Attenuation Factors				
				$\alpha = 7 \times 10^{-4}$ C _{gw} (ug/L)	$\alpha = 5 \times 10^{-4}$ C _{gw} (ug/L)	$\alpha = 3 \times 10^{-4}$ C _{gw} (ug/L)	$\alpha = 2 \times 10^{-4}$ C _{gw} (ug/L)	$\alpha = 1 \times 10^{-4}$ C _{gw} (ug/L)
83329	Acenaphthene	X	NC	**	**	**	**	**
75070	Acetaldehyde		NC	4.0E+03	5.6E+03	9.3E+03	1.4E+04	2.8E+04
67641	Acetone	X	NC	3.2E+05	4.4E+05	7.4E+05	1.1E+06	2.2E+06
75058	Acetonitrile		NC	6.1E+04	8.5E+04	1.4E+05	2.1E+05	4.2E+05
98862	Acetophenone	X	NC	1.1E+06	1.6E+06	2.7E+06	4.0E+06	**
107028	Acrolein		NC	5.7E+00	8.0E+00	1.3E+01	2.0E+01	4.0E+01
107131	Acrylonitrile		NC	6.8E+02	9.5E+02	1.6E+03	2.4E+03	4.7E+03
309002	Aldrin		C	1.0E+01	1.4E+01	**	**	**
319846	alpha-HCH (alpha-BHC)		C	4.5E+02	6.2E+02	1.0E+03	1.6E+03	**
100527	Benzaldehyde	X	NC	5.1E+05	7.2E+05	1.2E+06	1.8E+06	**
71432	Benzene		C	2.0E+02	2.7E+02	4.6E+02	6.9E+02	1.4E+03
205992	Benzo(b)fluoranthene	X	C	**	**	**	**	**
100447	Benzylchloride	X	C	4.2E+02	5.9E+02	9.8E+02	1.5E+03	3.0E+03
91587	beta-Chloronaphthalene	X	NC	**	**	**	**	**
92524	Biphenyl	X	NC	**	**	**	**	**
111444	Bis(2-chloroethyl)ether		C	1.4E+03	2.0E+03	3.3E+03	5.0E+03	1.0E+04
108601	Bis(2-chloroisopropyl)ether		C	7.3E+03	1.0E+04	1.7E+04	2.5E+04	5.1E+04
542881	Bis(chloromethyl)ether		C	6.4E-01	9.0E-01	1.5E+00	2.3E+00	4.5E+00
75274	Bromodichloromethane	X	C	3.0E+02	4.2E+02	7.0E+02	1.1E+03	2.1E+03
75252	Bromoform		C	1.2E+00	1.7E+00	2.8E+00	4.2E+00	8.3E+00
106990	1,3-Butadiene		C	4.1E-01	5.8E-01	9.6E-01	1.4E+00	2.9E+00
75150	Carbon disulfide		NC	8.1E+02	1.1E+03	1.9E+03	2.8E+03	5.6E+03
56235	Carbon tetrachloride		C	1.9E+01	2.6E+01	4.3E+01	6.5E+01	1.3E+02
57749	Chlordane		NC	**	**	**	**	**
126998	2-Chloro-1,3-butadiene (chloroprene)		NC	2.0E+01	2.9E+01	4.8E+01	7.1E+01	1.4E+02
108907	Chlorobenzene		NC	5.6E+02	7.9E+02	1.3E+03	2.0E+03	3.9E+03
109693	1-Chlorobutane	X	NC	2.9E+03	4.0E+03	6.7E+03	1.0E+04	2.0E+04
124481	Chlorodibromomethane	X	C	4.5E+02	6.3E+02	1.1E+03	1.6E+03	3.2E+03
75456	Chlorodifluoromethane		NC	**	**	**	**	**
75003	Chloroethane (ethyl chloride)		NC	4.0E+04	5.5E+04	9.2E+04	1.4E+05	2.8E+05
67663	Chloroform		C	1.0E+02	1.4E+02	2.3E+02	3.5E+02	7.0E+02
95578	2-Chlorophenol	X	NC	1.6E+03	2.2E+03	3.6E+03	5.5E+03	1.1E+04
75296	2-Chloropropane		NC	2.4E+02	3.4E+02	5.7E+02	8.6E+02	1.7E+03

Table 3a - GW: Question 5 Groundwater Screening Levels for Scenario-Specific Vapor Attenuation Factors (α)

Risk = 1×10^{-4}

Target Groundwater Concentrations at Different Attenuation Factors								
CAS No.	Chemical	Compounds with Provisional Toxicity Data Extrapolated From Oral Sources	Basis of Target Concentration C=cancer risk NC=noncancer risk	$\alpha = 7 \times 10^{-4}$ C_{gw} (ug/L)	$\alpha = 5 \times 10^{-4}$ C_{gw} (ug/L)	$\alpha = 3 \times 10^{-4}$ C_{gw} (ug/L)	$\alpha = 2 \times 10^{-4}$ C_{gw} (ug/L)	$\alpha = 1 \times 10^{-4}$ C_{gw} (ug/L)
218019	Chrysene	X	*	*	*	*	*	*
156592	cis-1,2-Dichloroethylene	X	NC	3.0E+02	4.2E+02	7.0E+02	1.0E+03	2.1E+03
123739	Crotonaldehyde (2-butenal)	X	C	8.0E+02	1.1E+03	1.9E+03	2.8E+03	5.6E+03
98828	Cumene		NC	1.2E+01	1.7E+01	2.8E+01	4.2E+01	8.4E+01
72559	DDE	X	C	**	**	**	**	**
132649	Dibenzofuran	X	NC	**	**	**	**	**
96128	1,2-Dibromo-3-chloropropane		NC	4.8E+01	6.7E+01	1.1E+02	1.7E+02	3.3E+02
106934	1,2-Dibromoethane (ethylene dibromide)		NC	9.4E+00	1.3E+01	2.2E+01	3.3E+01	6.6E+01
541731	1,3-Dichlorobenzene	X	NC	1.2E+03	1.7E+03	2.8E+03	4.1E+03	8.3E+03
95501	1,2-Dichlorobenzene		NC	3.7E+03	5.1E+03	8.6E+03	1.3E+04	2.6E+04
106467	1,4-Dichlorobenzene		NC	1.2E+04	1.6E+04	2.7E+04	4.1E+04	**
75718	Dichlorodifluoromethane		NC	2.0E+01	2.9E+01	4.8E+01	7.1E+01	1.4E+02
75343	1,1-Dichloroethane		NC	3.1E+03	4.4E+03	7.3E+03	1.1E+04	2.2E+04
107062	1,2-Dichloroethane		C	3.3E+02	4.7E+02	7.8E+02	1.2E+03	2.3E+03
75354	1,1-Dichloroethylene		NC	2.7E+02	3.7E+02	6.2E+02	9.4E+02	1.9E+03
78875	1,2-Dichloropropane		NC	5.0E+01	7.0E+01	1.2E+02	1.7E+02	3.5E+02
542756	1,3-Dichloropropene		NC	3.9E+01	5.5E+01	9.2E+01	1.4E+02	2.8E+02
60571	Dieldrin		C	1.2E+02	1.7E+02	**	**	**
115297	Endosulfan	X	NC	**	**	**	**	**
106898	Epichlorohydrin		NC	1.1E+03	1.6E+03	2.7E+03	4.0E+03	8.0E+03
60297	Ethyl ether	X	NC	7.4E+02	1.0E+03	1.7E+03	2.6E+03	5.2E+03
141786	Ethylacetate	X	NC	8.0E+05	1.1E+06	1.9E+06	2.8E+06	5.6E+06
100414	Ethylbenzene		C	9.8E+02	1.4E+03	2.3E+03	3.4E+03	6.9E+03
75218	Ethylene oxide		C	1.5E+02	2.1E+02	3.6E+02	5.4E+02	1.1E+03
97632	Ethylmethacrylate	X	NC	1.3E+04	1.8E+04	3.0E+04	4.6E+04	9.1E+04
86737	Fluorene	X	NC	**	**	**	**	**
110009	Furan	X	NC	2.3E+01	3.2E+01	5.3E+01	7.9E+01	1.6E+02
58899	gamma-HCH (Lindane)	X	C	1.6E+03	2.3E+03	3.8E+03	5.7E+03	**
76448	Heptachlor		C	4.0E-01 †	4.0E-01 †	4.0E-01 †	4.0E-01 †	4.0E-01 †
87683	Hexachloro-1,3-butadiene		C	4.7E+01	6.6E+01	1.1E+02	1.7E+02	3.3E+02
118741	Hexachlorobenzene		C	**	**	**	**	**
77474	Hexachlorocyclopentadiene		NC	5.0E+01 †	5.0E+01 †	5.0E+01 †	5.0E+01 †	5.0E+01 †
67721	Hexachloroethane		C	5.5E+02	7.6E+02	1.3E+03	1.9E+03	3.8E+03

Table 3a - GW: Question 5 Groundwater Screening Levels for Scenario-Specific Vapor Attenuation Factors (α)

Risk = 1×10^{-4}

Target Groundwater Concentrations at Different Attenuation Factors								
CAS No.	Chemical	Compounds with Provisional Toxicity Data Extrapolated From Oral Sources	Basis of Target Concentration C=cancer risk NC=noncancer risk	$\alpha = 7 \times 10^{-4}$ C_{gw} (ug/L)	$\alpha = 5 \times 10^{-4}$ C_{gw} (ug/L)	$\alpha = 3 \times 10^{-4}$ C_{gw} (ug/L)	$\alpha = 2 \times 10^{-4}$ C_{gw} (ug/L)	$\alpha = 1 \times 10^{-4}$ C_{gw} (ug/L)
110543	Hexane		NC	4.2E+00	5.9E+00	9.8E+00	1.5E+01	2.9E+01
74908	Hydrogen cyanide		NC	7.9E+02	1.1E+03	1.8E+03	2.8E+03	5.5E+03
78831	Isobutanol	X	NC	3.1E+06	4.4E+06	7.3E+06	1.1E+07	2.2E+07
7439976	Mercury (elemental)		NC	9.7E-01	1.4E+00	2.3E+00	3.4E+00	6.8E+00
126987	Methacrylonitrile		NC	9.9E+01	1.4E+02	2.3E+02	3.5E+02	6.9E+02
72435	Methoxychlor	X	NC	**	**	**	**	**
79209	Methyl acetate	X	NC	1.0E+06	1.4E+06	**	**	**
96333	Methyl acrylate	X	NC	2.0E+04	2.7E+04	4.6E+04	6.8E+04	1.4E+05
74839	Methyl bromide		NC	2.8E+01	3.9E+01	6.5E+01	9.8E+01	2.0E+02
74873	Methyl chloride (chloromethane)		NC	3.6E+02	5.0E+02	8.3E+02	1.2E+03	2.5E+03
108872	Methylcyclohexane		NC	1.0E+03	1.4E+03	2.4E+03	3.6E+03	7.1E+03
74953	Methylene bromide	X	NC	1.4E+03	2.0E+03	3.3E+03	5.0E+03	9.9E+03
75092	Methylene chloride		C	8.3E+03	1.2E+04	1.9E+04	2.9E+04	5.8E+04
78933	Methylethylketone (2-butanone)		NC	6.2E+05	8.7E+05	1.5E+06	2.2E+06	4.4E+06
108101	Methylisobutylketone		NC	2.0E+04	2.8E+04	4.7E+04	7.1E+04	1.4E+05
80626	Methylmethacrylate		NC	7.3E+04	1.0E+05	1.7E+05	2.5E+05	5.1E+05
91576	2-Methylnaphthalene	X	NC	4.7E+03	6.6E+03	1.1E+04	1.7E+04	**
1634044	MTBE		NC	1.7E+05	2.3E+05	3.9E+05	5.9E+05	1.2E+06
108383	m-Xylene	X	NC	3.3E+04	4.7E+04	7.8E+04	1.2E+05	**
91203	Naphthalene		NC	2.2E+02	3.0E+02	5.1E+02	7.6E+02	1.5E+03
104518	n-Butylbenzene	X	NC	3.7E+02	5.2E+02	8.7E+02	1.3E+03	**
98953	Nitrobenzene		NC	2.9E+03	4.1E+03	6.8E+03	1.0E+04	2.0E+04
79469	2-Nitropropane		C	2.6E+01	3.6E+01	6.0E+01	9.0E+01	1.8E+02
924163	N-Nitroso-di-n-butylamine		C	1.7E+01	2.4E+01	3.9E+01	5.9E+01	1.2E+02
103651	n-Propylbenzene	X	NC	4.6E+02	6.4E+02	1.1E+03	1.6E+03	3.2E+03
88722	o-Nitrotoluene	X	NC	9.8E+04	1.4E+05	2.3E+05	3.4E+05	**
95476	o-Xylene	X	NC	4.7E+04	6.6E+04	1.1E+05	1.6E+05	**
106423	p-Xylene	X	NC	3.2E+04	4.5E+04	7.4E+04	1.1E+05	**
129000	Pyrene	X	NC	**	**	**	**	**
135988	sec-Butylbenzene	X	NC	3.5E+02	4.9E+02	8.2E+02	1.2E+03	2.5E+03
100425	Styrene		NC	1.3E+04	1.8E+04	3.0E+04	4.4E+04	8.9E+04
98066	tert-Butylbenzene	X	NC	4.1E+02	5.8E+02	9.6E+02	1.4E+03	2.9E+03
630206	1,1,1,2-Tetrachloroethane		C	4.7E+02	6.6E+02	1.1E+03	1.7E+03	3.3E+03

Table 3a - GW: Question 5 Groundwater Screening Levels for Scenario-Specific Vapor Attenuation Factors (α)

Risk = 1×10^{-4}

Target Groundwater Concentrations at Different Attenuation Factors								
CAS No.	Chemical	Compounds with Provisional Toxicity Data Extrapolated From Oral Sources	Basis of Target Concentration C=cancer risk NC=noncancer risk	$\alpha = 7 \times 10^{-4}$ C_{gw} (ug/L)	$\alpha = 5 \times 10^{-4}$ C_{gw} (ug/L)	$\alpha = 3 \times 10^{-4}$ C_{gw} (ug/L)	$\alpha = 2 \times 10^{-4}$ C_{gw} (ug/L)	$\alpha = 1 \times 10^{-4}$ C_{gw} (ug/L)
79345	1,1,2,2-Tetrachloroethane		C	4.2E+02	5.9E+02	9.9E+02	1.5E+03	3.0E+03
127184	Tetrachloroethylene		C	1.5E+02	2.2E+02	3.6E+02	5.4E+02	1.1E+03
108883	Toluene		NC	2.1E+03	2.9E+03	4.9E+03	7.4E+03	1.5E+04
156605	trans-1,2-Dichloroethylene	X	NC	2.6E+02	3.6E+02	6.1E+02	9.1E+02	1.8E+03
76131	1,1,2-Trichloro-1,2,2-trifluoroethane		NC	2.2E+03	3.1E+03	5.1E+03	7.7E+03	1.5E+04
120821	1,2,4-Trichlorobenzene		NC	4.9E+03	6.9E+03	1.1E+04	1.7E+04	3.4E+04
79005	1,1,2-Trichloroethane		C	5.8E+02	8.1E+02	1.4E+03	2.0E+03	4.1E+03
71556	1,1,1-Trichloroethane		NC	4.5E+03	6.3E+03	1.0E+04	1.6E+04	3.1E+04
79016	Trichloroethylene ^{††}	X	C	7.5E+00	1.1E+01	1.8E+01	2.6E+01	5.3E+01
75694	Trichlorofluoromethane		NC	2.5E+02	3.5E+02	5.9E+02	8.8E+02	1.8E+03
96184	1,2,3-Trichloropropane		NC	4.2E+02	5.9E+02	9.8E+02	1.5E+03	2.9E+03
95636	1,2,4-Trimethylbenzene		NC	3.4E+01	4.7E+01	7.9E+01	1.2E+02	2.4E+02
108678	1,3,5-Trimethylbenzene		NC	3.5E+01	4.9E+01	8.2E+01	1.2E+02	2.5E+02
108054	Vinyl acetate		NC	1.4E+04	1.9E+04	3.2E+04	4.8E+04	9.6E+04
75014	Vinyl chloride (chloroethene)		C	3.6E+01	5.0E+01	8.3E+01	1.3E+02	2.5E+02

* Health-based target breathing concentration exceeds maximum possible chemical vapor concentration (pathway incomplete)

** Target soil gas concentration exceeds maximum possible vapor concentration at this soil gas to indoor air attenuation factor (pathway incomplete)

† The target groundwater concentrations is the MCL. (The MCL for chloroform is the MCL for total Trihalomethanes. The MCL listed for m-Xylene, o-Xylene, and p-Xylene is the MCL for total Xylenes.

†† The target concentration for trichloroethylene is based on the upper bound cancer slope factor identified in EPA's draft risk assessment for trichloroethylene (US EPA, 2001). The slope factor is based on state-of-the-art methodology, however the TCE assessment is still undergoing review. As a result, the slope factor and the target concentration values for TCE may be revised further. (See Appendix D.)

Table 3b - GW: Question 5 Groundwater Screening Levels for Scenario-Specific Vapor Attenuation Factors (α)

Risk = 1×10^{-5}

Target Groundwater Concentrations at Different Attenuation Factors								
CAS No.	Chemical	Compounds with Provisional Toxicity Data Extrapolated From Oral Sources	Basis of Target Concentration C=cancer risk NC=noncancer risk	$\alpha = 7 \times 10^{-4}$ C_{gw} (ug/L)	$\alpha = 5 \times 10^{-4}$ C_{gw} (ug/L)	$\alpha = 3 \times 10^{-4}$ C_{gw} (ug/L)	$\alpha = 2 \times 10^{-4}$ C_{gw} (ug/L)	$\alpha = 1 \times 10^{-4}$ C_{gw} (ug/L)
83329	Acenaphthene	X	NC	**	**	**	**	**
75070	Acetaldehyde		NC	4.0E+03	5.6E+03	9.3E+03	1.4E+04	2.8E+04
67641	Acetone	X	NC	3.2E+05	4.4E+05	7.4E+05	1.1E+06	2.2E+06
75058	Acetonitrile		NC	6.1E+04	8.5E+04	1.4E+05	2.1E+05	4.2E+05
98862	Acetophenone	X	NC	1.1E+06	1.6E+06	2.7E+06	4.0E+06	**
107028	Acrolein		NC	5.7E+00	8.0E+00	1.3E+01	2.0E+01	4.0E+01
107131	Acrylonitrile		C	1.2E+02	1.7E+02	2.8E+02	4.2E+02	8.5E+02
309002	Aldrin		C	1.0E+00	1.4E+00	2.4E+00	3.6E+00	7.1E+00
319846	alpha-HCH (alpha-BHC)		C	4.5E+01	6.2E+01	1.0E+02	1.6E+02	3.1E+02
100527	Benzaldehyde	X	NC	5.1E+05	7.2E+05	1.2E+06	1.8E+06	**
71432	Benzene		C	2.0E+01	2.7E+01	4.6E+01	6.9E+01	1.4E+02
205992	Benzo(b)fluoranthene	X	C	**	**	**	**	**
100447	Benzylchloride	X	C	4.2E+01	5.9E+01	9.8E+01	1.5E+02	3.0E+02
91587	beta-Chloronaphthalene	X	NC	**	**	**	**	**
92524	Biphenyl	X	NC	**	**	**	**	**
111444	Bis(2-chloroethyl)ether		C	1.4E+02	2.0E+02	3.3E+02	5.0E+02	1.0E+03
108601	Bis(2-chloroisopropyl)ether		C	7.3E+02	1.0E+03	1.7E+03	2.5E+03	5.1E+03
542881	Bis(chloromethyl)ether		C	6.4E-02	9.0E-02	1.5E-01	2.3E-01	4.5E-01
75274	Bromodichloromethane	X	C	3.0E+01	4.2E+01	7.0E+01	1.1E+02	2.1E+02
75252	Bromoform		C	1.2E-01	1.7E-01	2.8E-01	4.2E-01	8.3E-01
106990	1,3-Butadiene		C	4.1E-02	5.8E-02	9.6E-02	1.4E-01	2.9E-01
75150	Carbon disulfide		NC	8.1E+02	1.1E+03	1.9E+03	2.8E+03	5.6E+03
56235	Carbon tetrachloride		C	5.0E+00 †	5.0E+00 †	5.0E+00 †	6.5E+00	1.3E+01
57749	Chlordane		C	**	**	**	**	**
126998	2-Chloro-1,3-butadiene (chloroprene)		NC	2.0E+01	2.9E+01	4.8E+01	7.1E+01	1.4E+02
108907	Chlorobenzene		NC	5.6E+02	7.9E+02	1.3E+03	2.0E+03	3.9E+03
109693	1-Chlorobutane	X	NC	2.9E+03	4.0E+03	6.7E+03	1.0E+04	2.0E+04
124481	Chlorodibromomethane	X	C	4.5E+01	6.3E+01	1.1E+02	1.6E+02	3.2E+02
75456	Chlorodifluoromethane		NC	**	**	**	**	**
75003	Chloroethane (ethyl chloride)		NC	4.0E+04	5.5E+04	9.2E+04	1.4E+05	2.8E+05
67663	Chloroform		C	8.0E+01 †	8.0E+01 †	8.0E+01 †	8.0E+01 †	8.0E+01 †
95578	2-Chlorophenol	X	NC	1.6E+03	2.2E+03	3.6E+03	5.5E+03	1.1E+04
75296	2-Chloropropane		NC	2.4E+02	3.4E+02	5.7E+02	8.6E+02	1.7E+03

Table 3b - GW: Question 5 Groundwater Screening Levels for Scenario-Specific Vapor Attenuation Factors (α)

Risk = 1×10^{-5}

Target Groundwater Concentrations at Different Attenuation Factors								
CAS No.	Chemical	Compounds with Provisional Toxicity Data Extrapolated From Oral Sources	Basis of Target Concentration C=cancer risk NC=noncancer risk	$\alpha = 7 \times 10^{-4}$ C_{gw} (ug/L)	$\alpha = 5 \times 10^{-4}$ C_{gw} (ug/L)	$\alpha = 3 \times 10^{-4}$ C_{gw} (ug/L)	$\alpha = 2 \times 10^{-4}$ C_{gw} (ug/L)	$\alpha = 1 \times 10^{-4}$ C_{gw} (ug/L)
218019	Chrysene	X	C	**	**	**	**	**
156592	cis-1,2-Dichloroethylene	X	NC	3.0E+02	4.2E+02	7.0E+02	1.0E+03	2.1E+03
123739	Crotonaldehyde (2-butenal)	X	C	8.0E+01	1.1E+02	1.9E+02	2.8E+02	5.6E+02
98828	Cumene		NC	1.2E+01	1.7E+01	2.8E+01	4.2E+01	8.4E+01
72559	DDE	X	C	**	**	**	**	**
132649	Dibenzofuran	X	NC	**	**	**	**	**
96128	1,2-Dibromo-3-chloropropane		NC	4.8E+01	6.7E+01	1.1E+02	1.7E+02	3.3E+02
106934	1,2-Dibromoethane (ethylene dibromide)		C	5.2E+00	7.3E+00	1.2E+01	1.8E+01	3.6E+01
541731	1,3-Dichlorobenzene	X	NC	1.2E+03	1.7E+03	2.8E+03	4.1E+03	8.3E+03
95501	1,2-Dichlorobenzene		NC	3.7E+03	5.1E+03	8.6E+03	1.3E+04	2.6E+04
106467	1,4-Dichlorobenzene		NC	1.2E+04	1.6E+04	2.7E+04	4.1E+04	**
75718	Dichlorodifluoromethane		NC	2.0E+01	2.9E+01	4.8E+01	7.1E+01	1.4E+02
75343	1,1-Dichloroethane		NC	3.1E+03	4.4E+03	7.3E+03	1.1E+04	2.2E+04
107062	1,2-Dichloroethane		C	3.3E+01	4.7E+01	7.8E+01	1.2E+02	2.3E+02
75354	1,1-Dichloroethylene		NC	2.7E+02	3.7E+02	6.2E+02	9.4E+02	1.9E+03
78875	1,2-Dichloropropane		NC	5.0E+01	7.0E+01	1.2E+02	1.7E+02	3.5E+02
542756	1,3-Dichloropropene		C	1.2E+01	1.7E+01	2.8E+01	4.2E+01	8.4E+01
60571	Dieldrin		C	1.2E+01	1.7E+01	2.9E+01	4.3E+01	8.6E+01
115297	Endosulfan	X	NC	**	**	**	**	**
106898	Epichlorohydrin		NC	1.1E+03	1.6E+03	2.7E+03	4.0E+03	8.0E+03
60297	Ethyl ether	X	NC	7.4E+02	1.0E+03	1.7E+03	2.6E+03	5.2E+03
141786	Ethylacetate	X	NC	8.0E+05	1.1E+06	1.9E+06	2.8E+06	5.6E+06
100414	Ethylbenzene		C	7.0E+02 †	7.0E+02 †	7.0E+02 †	7.0E+02 †	7.0E+02 †
75218	Ethylene oxide		C	1.5E+01	2.1E+01	3.6E+01	5.4E+01	1.1E+02
97632	Ethylmethacrylate	X	NC	1.3E+04	1.8E+04	3.0E+04	4.6E+04	9.1E+04
86737	Fluorene	X	NC	**	**	**	**	**
110009	Furan	X	NC	2.3E+01	3.2E+01	5.3E+01	7.9E+01	1.6E+02
58899	gamma-HCH (Lindane)	X	C	1.6E+02	2.3E+02	3.8E+02	5.7E+02	1.1E+03
76448	Heptachlor		C	4.0E-01 †	4.0E-01 †	4.0E-01 †	4.0E-01 †	4.0E-01 †
87683	Hexachloro-1,3-butadiene		C	4.7E+00	6.6E+00	1.1E+01	1.7E+01	3.3E+01
118741	Hexachlorobenzene		C	1.4E+00	2.0E+00	3.3E+00	4.9E+00	**
77474	Hexachlorocyclopentadiene		NC	5.0E+01 †	5.0E+01 †	5.0E+01 †	5.0E+01 †	5.0E+01 †
67721	Hexachloroethane		C	5.5E+01	7.6E+01	1.3E+02	1.9E+02	3.8E+02

Table 3b - GW: Question 5 Groundwater Screening Levels for Scenario-Specific Vapor Attenuation Factors (α)

Risk = 1×10^{-5}

Target Groundwater Concentrations at Different Attenuation Factors								
CAS No.	Chemical	Compounds with Provisional Toxicity Data Extrapolated From Oral Sources	Basis of Target Concentration C=cancer risk NC=noncancer risk	$\alpha = 7 \times 10^{-4}$ C_{gw} (ug/L)	$\alpha = 5 \times 10^{-4}$ C_{gw} (ug/L)	$\alpha = 3 \times 10^{-4}$ C_{gw} (ug/L)	$\alpha = 2 \times 10^{-4}$ C_{gw} (ug/L)	$\alpha = 1 \times 10^{-4}$ C_{gw} (ug/L)
110543	Hexane		NC	4.2E+00	5.9E+00	9.8E+00	1.5E+01	2.9E+01
74908	Hydrogen cyanide		NC	7.9E+02	1.1E+03	1.8E+03	2.8E+03	5.5E+03
78831	Isobutanol	X	NC	3.1E+06	4.4E+06	7.3E+06	1.1E+07	2.2E+07
7439976	Mercury (elemental)		NC	9.7E-01	1.4E+00	2.3E+00	3.4E+00	6.8E+00
126987	Methacrylonitrile		NC	9.9E+01	1.4E+02	2.3E+02	3.5E+02	6.9E+02
72435	Methoxychlor	X	NC	**	**	**	**	**
79209	Methyl acetate	X	NC	1.0E+06	1.4E+06	**	**	**
96333	Methyl acrylate	X	NC	2.0E+04	2.7E+04	4.6E+04	6.8E+04	1.4E+05
74839	Methyl bromide		NC	2.8E+01	3.9E+01	6.5E+01	9.8E+01	2.0E+02
74873	Methyl chloride (chloromethane)		C	9.6E+01	1.3E+02	2.2E+02	3.4E+02	6.7E+02
108872	Methylcyclohexane		NC	1.0E+03	1.4E+03	2.4E+03	3.6E+03	7.1E+03
74953	Methylene bromide	X	NC	1.4E+03	2.0E+03	3.3E+03	5.0E+03	9.9E+03
75092	Methylene chloride		C	8.3E+02	1.2E+03	1.9E+03	2.9E+03	5.8E+03
78933	Methylethylketone (2-butanone)		NC	6.2E+05	8.7E+05	1.5E+06	2.2E+06	4.4E+06
108101	Methylisobutylketone		NC	2.0E+04	2.8E+04	4.7E+04	7.1E+04	1.4E+05
80626	Methylmethacrylate		NC	7.3E+04	1.0E+05	1.7E+05	2.5E+05	5.1E+05
91576	2-Methylnaphthalene	X	NC	4.7E+03	6.6E+03	1.1E+04	1.7E+04	**
1634044	MTBE		NC	1.7E+05	2.3E+05	3.9E+05	5.9E+05	1.2E+06
108383	m-Xylene	X	NC	3.3E+04	4.7E+04	7.8E+04	1.2E+05	**
91203	Naphthalene		NC	2.2E+02	3.0E+02	5.1E+02	7.6E+02	1.5E+03
104518	n-Butylbenzene	X	NC	3.7E+02	5.2E+02	8.7E+02	1.3E+03	**
98953	Nitrobenzene		NC	2.9E+03	4.1E+03	6.8E+03	1.0E+04	2.0E+04
79469	2-Nitropropane		C	2.6E+00	3.6E+00	6.0E+00	9.0E+00	1.8E+01
924163	N-Nitroso-di-n-butylamine		C	1.7E+00	2.4E+00	3.9E+00	5.9E+00	1.2E+01
103651	n-Propylbenzene	X	NC	4.6E+02	6.4E+02	1.1E+03	1.6E+03	3.2E+03
88722	o-Nitrotoluene	X	NC	9.8E+04	1.4E+05	2.3E+05	3.4E+05	**
95476	o-Xylene	X	NC	4.7E+04	6.6E+04	1.1E+05	1.6E+05	**
106423	p-Xylene	X	NC	3.2E+04	4.5E+04	7.4E+04	1.1E+05	**
129000	Pyrene	X	NC	**	**	**	**	**
135988	sec-Butylbenzene	X	NC	3.5E+02	4.9E+02	8.2E+02	1.2E+03	2.5E+03
100425	Styrene		NC	1.3E+04	1.8E+04	3.0E+04	4.4E+04	8.9E+04
98066	tert-Butylbenzene	X	NC	4.1E+02	5.8E+02	9.6E+02	1.4E+03	2.9E+03
630206	1,1,1,2-Tetrachloroethane		C	4.7E+01	6.6E+01	1.1E+02	1.7E+02	3.3E+02

Table 3b - GW: Question 5 Groundwater Screening Levels for Scenario-Specific Vapor Attenuation Factors (α)

Risk = 1×10^{-5}

Target Groundwater Concentrations at Different Attenuation Factors								
CAS No.	Chemical	Compounds with Provisional Toxicity Data Extrapolated From Oral Sources	Basis of Target Concentration C=cancer risk NC=noncancer risk	$\alpha = 7 \times 10^{-4}$ C_{gw} (ug/L)	$\alpha = 5 \times 10^{-4}$ C_{gw} (ug/L)	$\alpha = 3 \times 10^{-4}$ C_{gw} (ug/L)	$\alpha = 2 \times 10^{-4}$ C_{gw} (ug/L)	$\alpha = 1 \times 10^{-4}$ C_{gw} (ug/L)
79345	1,1,2,2-Tetrachloroethane		C	4.2E+01	5.9E+01	9.9E+01	1.5E+02	3.0E+02
127184	Tetrachloroethylene		C	1.5E+01	2.2E+01	3.6E+01	5.4E+01	1.1E+02
108883	Toluene		NC	2.1E+03	2.9E+03	4.9E+03	7.4E+03	1.5E+04
156605	trans-1,2-Dichloroethylene	X	NC	2.6E+02	3.6E+02	6.1E+02	9.1E+02	1.8E+03
76131	1,1,2-Trichloro-1,2,2-trifluoroethane		NC	2.2E+03	3.1E+03	5.1E+03	7.7E+03	1.5E+04
120821	1,2,4-Trichlorobenzene		NC	4.9E+03	6.9E+03	1.1E+04	1.7E+04	3.4E+04
79005	1,1,2-Trichloroethane		C	5.8E+01	8.1E+01	1.4E+02	2.0E+02	4.1E+02
71556	1,1,1-Trichloroethane		NC	4.5E+03	6.3E+03	1.0E+04	1.6E+04	3.1E+04
79016	Trichloroethylene ††	X	C	5.0E+00 †	5.0E+00 †	5.0E+00 †	5.0E+00 †	5.3E+00
75694	Trichlorofluoromethane		NC	2.5E+02	3.5E+02	5.9E+02	8.8E+02	1.8E+03
96184	1,2,3-Trichloropropane		NC	4.2E+02	5.9E+02	9.8E+02	1.5E+03	2.9E+03
95636	1,2,4-Trimethylbenzene		NC	3.4E+01	4.7E+01	7.9E+01	1.2E+02	2.4E+02
108678	1,3,5-Trimethylbenzene		NC	3.5E+01	4.9E+01	8.2E+01	1.2E+02	2.5E+02
108054	Vinyl acetate		NC	1.4E+04	1.9E+04	3.2E+04	4.8E+04	9.6E+04
75014	Vinyl chloride (chloroethene)		C	3.6E+00	5.0E+00	8.3E+00	1.3E+01	2.5E+01

* Health-based target breathing concentration exceeds maximum possible chemical vapor concentration (pathway incomplete)

** Target soil gas concentration exceeds maximum possible vapor concentration at this soil gas to indoor air attenuation factor (pathway incomplete)

† The target groundwater concentrations is the MCL. (The MCL for chloroform is the MCL for total Trihalomethanes. The MCL listed for m-Xylene, o-Xylene, and p-Xylene is the MCL for total Xylenes.

†† The target concentration for trichloroethylene is based on the upper bound cancer slope factor identified in EPA's draft risk assessment for trichloroethylene (US EPA, 2001). The slope factor is based on state-of-the-art methodology, however the TCE assessment is still undergoing review. As a result, the slope factor and the target concentration values for TCE may be revised further. (See Appendix D.)

Table 3c - GW: Question 5 Groundwater Screening Levels for Scenario-Specific Vapor Attenuation Factors (α)

Risk = 1×10^{-6}

Target Groundwater Concentrations at Different Attenuation Factors								
CAS No.	Chemical	Compounds with Provisional Toxicity Data Extrapolated From Oral Sources	Basis of Target Concentration C=cancer risk NC=noncancer risk	$\alpha = 7 \times 10^{-4}$ C_{gw} (ug/L)	$\alpha = 5 \times 10^{-4}$ C_{gw} (ug/L)	$\alpha = 3 \times 10^{-4}$ C_{gw} (ug/L)	$\alpha = 2 \times 10^{-4}$ C_{gw} (ug/L)	$\alpha = 1 \times 10^{-4}$ C_{gw} (ug/L)
83329	Acenaphthene	X	NC	**	**	**	**	**
75070	Acetaldehyde		C	4.9E+02	6.9E+02	1.1E+03	1.7E+03	3.4E+03
67641	Acetone	X	NC	3.2E+05	4.4E+05	7.4E+05	1.1E+06	2.2E+06
75058	Acetonitrile		NC	6.1E+04	8.5E+04	1.4E+05	2.1E+05	4.2E+05
98862	Acetophenone	X	NC	1.1E+06	1.6E+06	2.7E+06	4.0E+06	**
107028	Acrolein		NC	5.7E+00	8.0E+00	1.3E+01	2.0E+01	4.0E+01
107131	Acrylonitrile		C	1.2E+01	1.7E+01	2.8E+01	4.2E+01	8.5E+01
309002	Aldrin		C	1.0E-01	1.4E-01	2.4E-01	3.6E-01	7.1E-01
319846	alpha-HCH (alpha-BHC)		C	4.5E+00	6.2E+00	1.0E+01	1.6E+01	3.1E+01
100527	Benzaldehyde	X	NC	5.1E+05	7.2E+05	1.2E+06	1.8E+06	**
71432	Benzene		C	5.0E+00 †	5.0E+00 †	5.0E+00 †	6.9E+00	1.4E+01
205992	Benzo(b)fluoranthene	X	C	**	**	**	**	**
100447	Benzylchloride	X	C	4.2E+00	5.9E+00	9.8E+00	1.5E+01	3.0E+01
91587	beta-Chloronaphthalene	X	NC	**	**	**	**	**
92524	Biphenyl	X	NC	**	**	**	**	**
111444	Bis(2-chloroethyl)ether		C	1.4E+01	2.0E+01	3.3E+01	5.0E+01	1.0E+02
108601	Bis(2-chloroisopropyl)ether		C	7.3E+01	1.0E+02	1.7E+02	2.5E+02	5.1E+02
542881	Bis(chloromethyl)ether		C	6.4E-03	9.0E-03	1.5E-02	2.3E-02	4.5E-02
75274	Bromodichloromethane	X	C	3.0E+00	4.2E+00	7.0E+00	1.1E+01	2.1E+01
75252	Bromoform		C	1.2E-02	1.7E-02	2.8E-02	4.2E-02	8.3E-02
106990	1,3-Butadiene		C	4.1E-03	5.8E-03	9.6E-03	1.4E-02	2.9E-02
75150	Carbon disulfide		NC	8.1E+02	1.1E+03	1.9E+03	2.8E+03	5.6E+03
56235	Carbon tetrachloride		C	5.0E+00 †	5.0E+00 †	5.0E+00 †	5.0E+00 †	5.0E+00 †
57749	Chlordane		C	1.7E+01	2.4E+01	4.1E+01	**	**
126998	2-Chloro-1,3-butadiene (chloroprene)		NC	2.0E+01	2.9E+01	4.8E+01	7.1E+01	1.4E+02
108907	Chlorobenzene		NC	5.6E+02	7.9E+02	1.3E+03	2.0E+03	3.9E+03
109693	1-Chlorobutane	X	NC	2.9E+03	4.0E+03	6.7E+03	1.0E+04	2.0E+04
124481	Chlorodibromomethane	X	C	4.5E+00	6.3E+00	1.1E+01	1.6E+01	3.2E+01
75456	Chlorodifluoromethane		NC	**	**	**	**	**
75003	Chloroethane (ethyl chloride)		NC	4.0E+04	5.5E+04	9.2E+04	1.4E+05	2.8E+05
67663	Chloroform		C	8.0E+01 †	8.0E+01 †	8.0E+01 †	8.0E+01 †	8.0E+01 †
95578	2-Chlorophenol	X	NC	1.6E+03	2.2E+03	3.6E+03	5.5E+03	1.1E+04
75296	2-Chloropropane		NC	2.4E+02	3.4E+02	5.7E+02	8.6E+02	1.7E+03

Table 3c - GW: Question 5 Groundwater Screening Levels for Scenario-Specific Vapor Attenuation Factors (α)

Risk = 1×10^{-6}

Target Groundwater Concentrations at Different Attenuation Factors								
CAS No.	Chemical	Compounds with Provisional Toxicity Data Extrapolated From Oral Sources	Basis of Target Concentration C=cancer risk NC=noncancer risk	$\alpha = 7 \times 10^{-4}$ C_{gw} (ug/L)	$\alpha = 5 \times 10^{-4}$ C_{gw} (ug/L)	$\alpha = 3 \times 10^{-4}$ C_{gw} (ug/L)	$\alpha = 2 \times 10^{-4}$ C_{gw} (ug/L)	$\alpha = 1 \times 10^{-4}$ C_{gw} (ug/L)
218019	Chrysene	X	C	**	**	**	**	**
156592	cis-1,2-Dichloroethylene	X	NC	3.0E+02	4.2E+02	7.0E+02	1.0E+03	2.1E+03
123739	Crotonaldehyde (2-butenal)	X	C	8.0E+00	1.1E+01	1.9E+01	2.8E+01	5.6E+01
98828	Cumene		NC	1.2E+01	1.7E+01	2.8E+01	4.2E+01	8.4E+01
72559	DDE	X	C	4.2E+01	5.8E+01	9.7E+01	**	**
132649	Dibenzofuran	X	NC	**	**	**	**	**
96128	1,2-Dibromo-3-chloropropane		NC	4.8E+01	6.7E+01	1.1E+02	1.7E+02	3.3E+02
106934	1,2-Dibromoethane (ethylene dibromide)		C	5.2E-01	7.3E-01	1.2E+00	1.8E+00	3.6E+00
541731	1,3-Dichlorobenzene	X	NC	1.2E+03	1.7E+03	2.8E+03	4.1E+03	8.3E+03
95501	1,2-Dichlorobenzene		NC	3.7E+03	5.1E+03	8.6E+03	1.3E+04	2.6E+04
106467	1,4-Dichlorobenzene		NC	1.2E+04	1.6E+04	2.7E+04	4.1E+04	**
75718	Dichlorodifluoromethane		NC	2.0E+01	2.9E+01	4.8E+01	7.1E+01	1.4E+02
75343	1,1-Dichloroethane		NC	3.1E+03	4.4E+03	7.3E+03	1.1E+04	2.2E+04
107062	1,2-Dichloroethane		C	5.0E+00 †	5.0E+00 †	7.8E+00	1.2E+01	2.3E+01
75354	1,1-Dichloroethylene		NC	2.7E+02	3.7E+02	6.2E+02	9.4E+02	1.9E+03
78875	1,2-Dichloropropane		NC	5.0E+01	7.0E+01	1.2E+02	1.7E+02	3.5E+02
542756	1,3-Dichloropropene		C	1.2E+00	1.7E+00	2.8E+00	4.2E+00	8.4E+00
60571	Dieldrin		C	1.2E+00	1.7E+00	2.9E+00	4.3E+00	8.6E+00
115297	Endosulfan	X	NC	**	**	**	**	**
106898	Epichlorohydrin		NC	1.1E+03	1.6E+03	2.7E+03	4.0E+03	8.0E+03
60297	Ethyl ether	X	NC	7.4E+02	1.0E+03	1.7E+03	2.6E+03	5.2E+03
141786	Ethylacetate	X	NC	8.0E+05	1.1E+06	1.9E+06	2.8E+06	5.6E+06
100414	Ethylbenzene		C	7.0E+02 †	7.0E+02 †	7.0E+02 †	7.0E+02 †	7.0E+02 †
75218	Ethylene oxide		C	1.5E+00	2.1E+00	3.6E+00	5.4E+00	1.1E+01
97632	Ethylmethacrylate	X	NC	1.3E+04	1.8E+04	3.0E+04	4.6E+04	9.1E+04
86737	Fluorene	X	NC	**	**	**	**	**
110009	Furan	X	NC	2.3E+01	3.2E+01	5.3E+01	7.9E+01	1.6E+02
58899	gamma-HCH (Lindane)	X	C	1.6E+01	2.3E+01	3.8E+01	5.7E+01	1.1E+02
76448	Heptachlor		C	4.0E-01 †	4.0E-01 †	4.0E-01 †	4.0E-01 †	4.0E-01 †
87683	Hexachloro-1,3-butadiene		C	4.7E-01	6.6E-01	1.1E+00	1.7E+00	3.3E+00
118741	Hexachlorobenzene		C	1.0E+00 †	1.0E+00 †	1.0E+00 †	1.0E+00 †	1.0E+00 †
77474	Hexachlorocyclopentadiene		NC	5.0E+01 †	5.0E+01 †	5.0E+01 †	5.0E+01 †	5.0E+01 †
67721	Hexachloroethane		C	5.5E+00	7.6E+00	1.3E+01	1.9E+01	3.8E+01

Table 3c - GW: Question 5 Groundwater Screening Levels for Scenario-Specific Vapor Attenuation Factors (α)

Risk = 1×10^{-6}

Target Groundwater Concentrations at Different Attenuation Factors								
CAS No.	Chemical	Compounds with Provisional Toxicity Data Extrapolated From Oral Sources	Basis of Target Concentration C=cancer risk NC=noncancer risk	$\alpha = 7 \times 10^{-4}$ C_{gw} (ug/L)	$\alpha = 5 \times 10^{-4}$ C_{gw} (ug/L)	$\alpha = 3 \times 10^{-4}$ C_{gw} (ug/L)	$\alpha = 2 \times 10^{-4}$ C_{gw} (ug/L)	$\alpha = 1 \times 10^{-4}$ C_{gw} (ug/L)
110543	Hexane		NC	4.2E+00	5.9E+00	9.8E+00	1.5E+01	2.9E+01
74908	Hydrogen cyanide		NC	7.9E+02	1.1E+03	1.8E+03	2.8E+03	5.5E+03
78831	Isobutanol	X	NC	3.1E+06	4.4E+06	7.3E+06	1.1E+07	2.2E+07
7439976	Mercury (elemental)		NC	9.7E-01	1.4E+00	2.3E+00	3.4E+00	6.8E+00
126987	Methacrylonitrile		NC	9.9E+01	1.4E+02	2.3E+02	3.5E+02	6.9E+02
72435	Methoxychlor	X	NC	**	**	**	**	**
79209	Methyl acetate	X	NC	1.0E+06	1.4E+06	**	**	**
96333	Methyl acrylate	X	NC	2.0E+04	2.7E+04	4.6E+04	6.8E+04	1.4E+05
74839	Methyl bromide		NC	2.8E+01	3.9E+01	6.5E+01	9.8E+01	2.0E+02
74873	Methyl chloride (chloromethane)		C	9.6E+00	1.3E+01	2.2E+01	3.4E+01	6.7E+01
108872	Methylcyclohexane		NC	1.0E+03	1.4E+03	2.4E+03	3.6E+03	7.1E+03
74953	Methylene bromide	X	NC	1.4E+03	2.0E+03	3.3E+03	5.0E+03	9.9E+03
75092	Methylene chloride		C	8.3E+01	1.2E+02	1.9E+02	2.9E+02	5.8E+02
78933	Methylethylketone (2-butanone)		NC	6.2E+05	8.7E+05	1.5E+06	2.2E+06	4.4E+06
108101	Methylisobutylketone		NC	2.0E+04	2.8E+04	4.7E+04	7.1E+04	1.4E+05
80626	Methylmethacrylate		NC	7.3E+04	1.0E+05	1.7E+05	2.5E+05	5.1E+05
91576	2-Methylnaphthalene	X	NC	4.7E+03	6.6E+03	1.1E+04	1.7E+04	**
1634044	MTBE		NC	1.7E+05	2.3E+05	3.9E+05	5.9E+05	1.2E+06
108383	m-Xylene	X	NC	3.3E+04	4.7E+04	7.8E+04	1.2E+05	**
91203	Naphthalene		NC	2.2E+02	3.0E+02	5.1E+02	7.6E+02	1.5E+03
104518	n-Butylbenzene	X	NC	3.7E+02	5.2E+02	8.7E+02	1.3E+03	**
98953	Nitrobenzene		NC	2.9E+03	4.1E+03	6.8E+03	1.0E+04	2.0E+04
79469	2-Nitropropane		C	2.6E-01	3.6E-01	6.0E-01	9.0E-01	1.8E+00
924163	N-Nitroso-di-n-butylamine		C	1.7E-01	2.4E-01	3.9E-01	5.9E-01	1.2E+00
103651	n-Propylbenzene	X	NC	4.6E+02	6.4E+02	1.1E+03	1.6E+03	3.2E+03
88722	o-Nitrotoluene	X	NC	9.8E+04	1.4E+05	2.3E+05	3.4E+05	**
95476	o-Xylene	X	NC	4.7E+04	6.6E+04	1.1E+05	1.6E+05	**
106423	p-Xylene	X	NC	3.2E+04	4.5E+04	7.4E+04	1.1E+05	**
129000	Pyrene	X	NC	**	**	**	**	**
135988	sec-Butylbenzene	X	NC	3.5E+02	4.9E+02	8.2E+02	1.2E+03	2.5E+03
100425	Styrene		NC	1.3E+04	1.8E+04	3.0E+04	4.4E+04	8.9E+04
98066	tert-Butylbenzene	X	NC	4.1E+02	5.8E+02	9.6E+02	1.4E+03	2.9E+03
630206	1,1,1,2-Tetrachloroethane		C	4.7E+00	6.6E+00	1.1E+01	1.7E+01	3.3E+01

Table 3c - GW: Question 5 Groundwater Screening Levels for Scenario-Specific Vapor Attenuation Factors (α)

Risk = 1×10^{-6}

Target Groundwater Concentrations at Different Attenuation Factors								
CAS No.	Chemical	Compounds with Provisional Toxicity Data Extrapolated From Oral Sources	Basis of Target Concentration C=cancer risk NC=noncancer risk	$\alpha = 7 \times 10^{-4}$ C_{gw} (ug/L)	$\alpha = 5 \times 10^{-4}$ C_{gw} (ug/L)	$\alpha = 3 \times 10^{-4}$ C_{gw} (ug/L)	$\alpha = 2 \times 10^{-4}$ C_{gw} (ug/L)	$\alpha = 1 \times 10^{-4}$ C_{gw} (ug/L)
79345	1,1,2,2-Tetrachloroethane		C	4.2E+00	5.9E+00	9.9E+00	1.5E+01	3.0E+01
127184	Tetrachloroethylene		C	5.0E+00 †	5.0E+00 †	5.0E+00 †	5.4E+00	1.1E+01
108883	Toluene		NC	2.1E+03	2.9E+03	4.9E+03	7.4E+03	1.5E+04
156605	trans-1,2-Dichloroethylene	X	NC	2.6E+02	3.6E+02	6.1E+02	9.1E+02	1.8E+03
76131	1,1,2-Trichloro-1,2,2-trifluoroethane		NC	2.2E+03	3.1E+03	5.1E+03	7.7E+03	1.5E+04
120821	1,2,4-Trichlorobenzene		NC	4.9E+03	6.9E+03	1.1E+04	1.7E+04	3.4E+04
79005	1,1,2-Trichloroethane		C	5.8E+00	8.1E+00	1.4E+01	2.0E+01	4.1E+01
71556	1,1,1-Trichloroethane		NC	4.5E+03	6.3E+03	1.0E+04	1.6E+04	3.1E+04
79016	Trichloroethylene ††	X	C	5.0E+00 †	5.0E+00 †	5.0E+00 †	5.0E+00 †	5.0E+00 †
75694	Trichlorofluoromethane		NC	2.5E+02	3.5E+02	5.9E+02	8.8E+02	1.8E+03
96184	1,2,3-Trichloropropane		NC	4.2E+02	5.9E+02	9.8E+02	1.5E+03	2.9E+03
95636	1,2,4-Trimethylbenzene		NC	3.4E+01	4.7E+01	7.9E+01	1.2E+02	2.4E+02
108678	1,3,5-Trimethylbenzene		NC	3.5E+01	4.9E+01	8.2E+01	1.2E+02	2.5E+02
108054	Vinyl acetate		NC	1.4E+04	1.9E+04	3.2E+04	4.8E+04	9.6E+04
75014	Vinyl chloride (chloroethene)		C	2.0E+00 †	2.0E+00 †	2.0E+00 †	2.0E+00 †	2.5E+00

* Health-based target breathing concentration exceeds maximum possible chemical vapor concentration (pathway incomplete)

** Target soil gas concentration exceeds maximum possible vapor concentration at this soil gas to indoor air attenuation factor (pathway incomplete)

† The target groundwater concentrations is the MCL. (The MCL for chloroform is the MCL for total Trihalomethanes. The MCL listed for m-Xylene, o-Xylene, and p-Xylene is the MCL for total Xylenes.

†† The target concentration for trichloroethylene is based on the upper bound cancer slope factor identified in EPA's draft risk assessment for trichloroethylene (US EPA, 2001). The slope factor is based on state-of-the-art methodology, however the TCE assessment is still undergoing review. As a result, the slope factor and the target concentration values for TCE may be revised further. (See Appendix D.)

VOC Methods Analyte Lists

List 1 Office of Solid Waste SW 846 Method 8260 C	
Acetone Acetonitrile Acrolein (Propenal) Acrylonitrile Allyl alcohol Allyl chloride Benzene Benzyl chloride Bis(2-chloroethyl)sulfide Bromoacetone Bromochloromethane Bromodichloromethane Bromoform Bromomethane n-Butanol 2-Butanone (MEK) t-Butyl alcohol Carbon disulfide Carbon tetrachloride Chloral hydrate Chlorobenzene Chlorodibromomethane Chloroethane 2-Chloroethanol 2-Chloroethyl vinyl ether Chloroform Chloromethane Chloroprene 3-Chloropropionitrile Crotonaldehyde 1,2-Dibromo-3-chloropropane 1,2-Dibromoethane Dibromomethane 1,2-Dichlorobenzene 1,3-Dichlorobenzene 1,4-Dichlorobenzene cis-1,4-Dichloro-2-butene trans-1,4-Dichloro-2-butene Dichlorodifluoromethane 1,1-Dichloroethane 1,2-Dichloroethane 1,1-Dichloroethene trans-1,2-Dichloroethene 1,2-Dichloropropane 1,3-Dichloro-2-propanol cis-1,3-Dichloropropene trans-1,3-Dichloropropene 1,2,3,4-Diepoxybutane Diethyl ether 1,4-Dioxane Epichlorohydrin	Ethanol Ethyl acetate Ethylbenzene Ethylene oxide Ethyl methacrylate Hexachlorobutadiene Hexachloroethane 2-Hexanone 2-Hydroxypropionitrile Iodomethane Isobutyl alcohol Isopropylbenzene Malononitrile Methacrylonitrile Methanol Methylene chloride Methyl methacrylate 4-Methyl-2-pentanone (MIBK) Naphthalene Bromobenzene 1,3-Dichloropropane n-Butylbenzene 2,2-Dichloropropane sec-Butylbenzene 1,1-Dichloropropene tert-Butylbenzene p-Isopropyltoluene Chloroacetonitrile Methyl acrylate 1-Chlorobutane Methyl-t-butyl ether 1-Chlorohexane Pentafluorobenzene 2-Chlorotoluene n-Propylbenzene 4-Chlorotoluene 1,2,3-Trichlorobenzene Dibromofluoromethane 1,2,4-Trimethylbenzene cis-1,2-Dichloroethene 1,3,5-trimethylbenzene

VOC Methods Analyte Lists (cont.)

List 2 EPA Office of Water Method 524.2	List 3 OERR (Superfund) CLP Statement of Work OLM04.2
Chloroform	1,1-Dichloroethane
Bromodichloromethane	1,1-Dichloroethene
Bromoform	1,1,1-Trichloroethane
Chlorodibromomethane	1,1,2-Trichloro-
Bromobenzene	1,1,2-Trichloroethane
Bromochloromethane	1,1,2,2-Tetrachloroethane
Bromomethane	1,2-Dibromo-3-chloropropane
n-Butylbenzene	1,2-Dibromoethane
tert-Butylbenzene	1,2-Dichlorobenzene
Chloroethane	1,2-Dichloroethane
Chloromethane	1,2-Dichloropropane
o-Chlorotoluene	1,2,2-trifluoroethane
p-Chlorotoluene	1,2,4-Trichlorobenzene
Dibromomethane	1,3-Dichlorobenzene
m-Dichlorobenzene	1,4-Dichlorobenzene
Dichlorodifluoromethane	2-Butanone [78-93-3]
1,1-Dichloroethane	2-Hexanone
1,3-Dichloropropane	4-Methyl-2-pentanone
2,2-Dichloropropane	Acetone
1,1-Dichloropropene	Benzene
1,3-Dichloropropene	Bromodichloromethane
Fluorotrichloromethane	Bromoform
Hexachlorobutadiene	Bromomethane
Isopropylbenzene	Carbon Disulfide
p-Isopropyltoluene	Carbon Tetrachloride [56-23-5]
Naphthalene	Chlorobenzene
n-Propylbenzene	Chloroethane
1,1,2,2-Tetrachloroethane	Chloroform [67-66-3]
1,1,1,2-Tetrachloroethane	Chloromethane
1,2,3-Trichlorobenzene	cis-1,2-Dichloroethene
1,2,3-Trichloropropane	cis-1,3-Dichloropropene
1,2,4-Trimethylbenzene	Cyclohexane [110-82-7]
1,3,5 -Trimethylbenzene	Dibromochloromethane
	Dichlorodifluoromethane
	Ethylbenzene
	Isopropylbenzene
	Methyl tert-Butyl Ether
	Methyl Acetate
	Methylcyclohexane
	Methylene Chloride
	Styrene
	Tetrachloroethene
	Toluene
	trans-1,2-Dichloroethene
	trans-1,3-Dichloropropene
	Trichloroethene
	Trichlorofluoromethane
	Vinyl Chloride
	Xylenes (total)

VOC Methods Analyte Lists (cont.)

List 4 OERR (Superfund) CLP Statement of Work OLC03.2	List 5 Office of Solid Waste SW 846 Method 5041
1,1-Dichloroethane 1,1-Dichloroethene 1,1,1-Trichloroethane 1,1,2-Trichloro-1,2,2-trifluoroethane 1,1,2-Trichloroethane 1,1,2,2-Tetrachloroethane 1,2-Dibromo-3-chloropropane 1,2-Dibromoethane 1,2-Dichlorobenzene 1,2-Dichloroethane 1,2-Dichloropropane 1,2,3-Trichlorobenzene 1,2,4-Trichlorobenzene 1,3-Dichlorobenzene 1,4-Dichlorobenzene 2-Butanone 2-Hexanone 4-Methyl-2-pentanone Acetone Benzene Bromochloromethane Bromodichloromethane Bromoform Bromomethane Carbon Disulfide Carbon Tetrachloride Chlorobenzene Chloroethane Chloroform Chloromethane cis-1,2-Dichloroethene cis-1,3-Dichloropropene Cyclohexane Dibromochloromethane Dichlorodifluoromethane Ethylbenzene Isopropylbenzene Methyl Acetate Methyl tert-Butyl Ether Methylcyclohexane Methylene Chloride Styrene Tetrachloroethene Toluene trans-1,2-Dichloroethene trans-1,3-Dichloropropene Trichloroethene Trichlorofluoromethane Vinyl Chloride Xylenes (total)	Acetone Acrylonitrile Benzene Bromodichloromethane Bromoform Bromomethane Carbon disulfide Carbon tetrachloride Chlorobenzene Chlorodibromomethane Chloroethane Chloroform Chloromethane Dibromomethane 1,1-Dichloroethane 1,2-Dichloroethane 1,1-Dichloroethene trans-1,2-Dichloroethene 1,2-Dichloropropane cis-1,3-Dichloropropene trans-1,3-Dichloropropene Ethylbenzene Iodomethane Methylene chloride Styrene 1,1,2,2-Tetrachloroethane Tetrachloroethene Toluene 1,1,1-Trichloroethane 1,1,2-Trichloroethane Trichloroethene Trichlorofluoromethane 1,2,3-Trichloropropane Vinyl chloride Xylenes

VOC Methods Analyte Lists (cont.)

List 6 NIOSH Method 1003	List 7 NIOSH Method 1501
Benzyl chloride	1-tert-butyl-4-methylbenzene
Bromoform	a-methylstyrene
Carbon tetrachlorideab	benzene
Chlorobenzene	cumene
Chlorobromomethane	dimethylbenzene (p-xylene) (meta)
Chloroform	ethylbenzene
o-Dichlorobenzene	isopropenylbenzene
p-Dichlorobenzene	isopropylbenzene
1,1-Dichloroethane	methylbenzene
1,2-Dichloroethylene	methylstyrene
Ethylene dichloride	methylvinylbenzene (ortho)
Hexachloroethane	naphthalene
1,1,1-trichloroethane	p-tert-butyltoluene
Tetrachloroethylene	styrene
1,1,2-Trichloroethane	toluene
1,2,3-Trichloropropane	vinylbenzene
	xylene

VOC Methods Analyte Lists (cont.)

List 8 EPA Office of Air and Radiation TO-15 & TO-17	
<p>1,1-Dimethylhydrazine; 1,1,2-Trichloroethane; 1,1,2,2-Tetrachloroethane; 1,2-Dibromo-3-chloropropane; 1,2-Epoxybutane (1,2-butylene oxide); 1,2-Propyleneimine (2-methylazindine); 1,2,4-Trichlorobenzene; 1,3-Butadiene; 1,3-Dichloropropene; 1,3-Propane sultone; 1,4-Dichlorobenzene (p-); 1,4-Dioxane (1,4 Diethylene oxide); 2-Nitropropane; 2,2,4-Trimethyl pentane; Acetaldehyde (ethanal); Acetonitrile (cyanomethane); Acetophenone; Acrolein (2-propenal); Acrylamide; Acrylic acid; Acrylonitrile (2-propenenitrile); Allyl chloride (3-chloropropene); Aniline (aminobenzene); Benzene; Benzyl chloride (a-chlorotoluene); Beta-Propiolactone; Bis(2-Chloroethyl)ether; Bis(chloromethyl) ether; Bromoform (tribromomethane); Carbon tetrachloride; Carbon disulfide; Carbonyl sulfide; Catechol (o-hydroxyphenol); Chloroacetic acid; Chlorobenzene; Chloroform; Chloromethyl methyl ether; Chloroprene (2-chloro-1,3-butadiene); Cresylic acid (cresol isomer mixture); Cumene (isopropylbenzene); Diazomethane; Diethyl sulfate; Dimethyl sulfate; Dimethylcarbaryl chloride; Epichlorohydrin (1-chloro-2,3-epoxy propane); Ethyl acrylate; Ethyl carbamate (urethane); Ethyl chloride (chloroethane); Ethylbenzene; Ethylene dibromide (1,2-dibromoethane);</p>	<p>Ethylene dichloride (1,2-dichloroethane); Ethylene oxide; Ethyleneimine (aziridine); Ethylidene dichloride (1,1-dichloroethane); Formaldehyde; Hexachlorobutadiene; Hexachloroethane; Hexane; Isophorone; m-Xylene; Methanol; Methyl methacrylate; Methyl isobutyl ketone (hexone); Methyl chloride (chloromethane); Methyl bromide (bromomethane); Methyl ethyl ketone (2-butanone); Methyl isocyanate; Methyl iodide (iodomethane); Methyl chloroform (1,1,1 trichloroethane); Methyl tert-butyl ether; Methylene chloride; Methylhydrazine; N-Nitrosodimethylamine; N-Nitrosomorpholine; N-Nitroso-N-methylurea; Nitrobenzene; N,N-Dimethylaniline; N,N-Dimethylformamide; o-Cresol; o-Xylene; p-Xylene; Phenol; Phosgene; Propionaldehyde; Propylene dichloride (1,2-dichloropropane); Propylene oxide; Styrene oxide; Styrene; Tetrachloroethylene; Toluene; Trichloroethylene; Triethylamine; Vinyl acetate; Vinyl bromide (bromoethene); Vinyl chloride (chloroethene); Vinylidene chloride (1,1-dichloroethylene); Xylenes (isomer & mixtures);</p>

(1) The following provide more specific guidance for developing a CSM for cleanup programs:

Soil Screening Guidance: User's Guide, Part 2.1 and Attachment A; EPA-540-R-96-018. Office of Emergency and Remedial Response/EPA. July 1996.

Supplemental Guidance for Developing Soil Screening Levels for Superfund Sites
Office of Emergency and Remedial Response/EPA

Risk Assessment Guidance for Superfund (RAGS): Volume I - Human Health Evaluation Manual, Part D - (Standardized Planning, Reporting, and Review of Superfund Risk Assessments), Final December 2001. Pub. # - 9285.7-47; *Chapter 2 - Risk Considerations in Project Scoping*; EPA - Office of Emergency and Remedial Response.

Site Conceptual Exposure Model Builder - User Manual - for PC (Windows version) application to assist in preparing a site model; U.S. Dept of Energy, RCRA/CERCLA Division; July 1997.

Guidance for Conducting Remedial Investigations and Feasibility Studies under CERCLA. EPA 540-G-89-004. Office of Emergency and Remedial Response/EPA . 1989.

Expedited Site Assessment Tools for Underground Storage Tank Sites: A Guide for Regulators. Chapter 2. EPA 510-B-97-001; Office of Underground Storage Tanks/EPA; March 1997.

(2) Selected risk assessment guidance and related documents that contain discussions concerning necessary problem formulation, and planning and scoping prior to conducting a risk assessment can provide some additional perspective to consider in preparation of a Conceptual Site Model.

Quality Assurance Guidance for Conducting Brownfields Site Assessments, EPA 540-R-98-038; OSWER 9230.0-83P; PB98-963307; September 1998.

Guidelines for Ecological Risk Assessment, EPA 630-R-95-002F, Federal Register Vol 63, pp.26846-26924; May 14, 1998.

Framework for Cumulative Risk Assessment - External Review Draft, EPA 630-P-02-001A; Risk Assessment Forum; April 23, 2002.

Risk Characterization Handbook, EPA 100-B-00-002, December 2000.

Guidance For The Data Quality Objectives Process - EPA QA/G-4; EPA-600-R-96-055; September 1994.

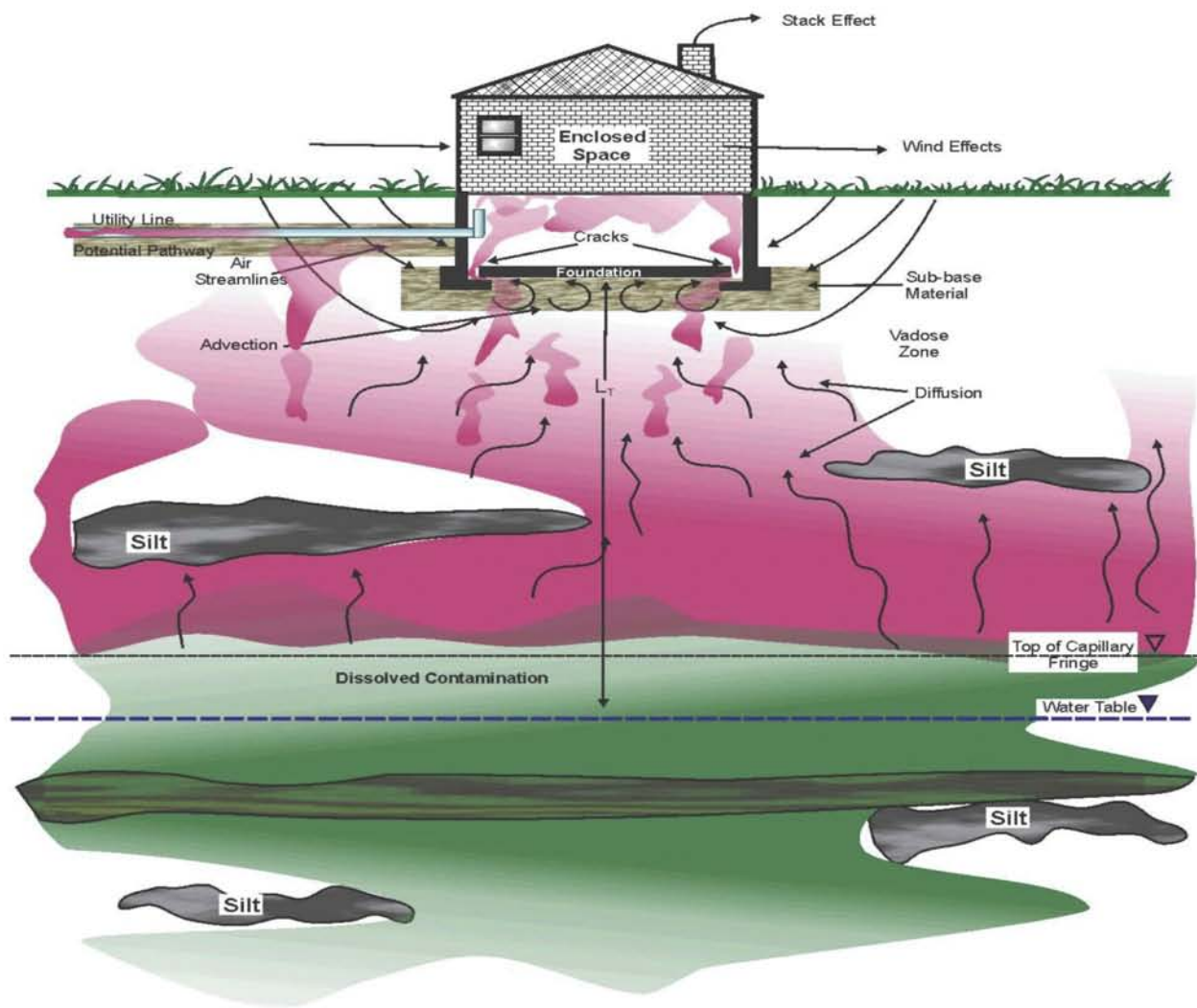
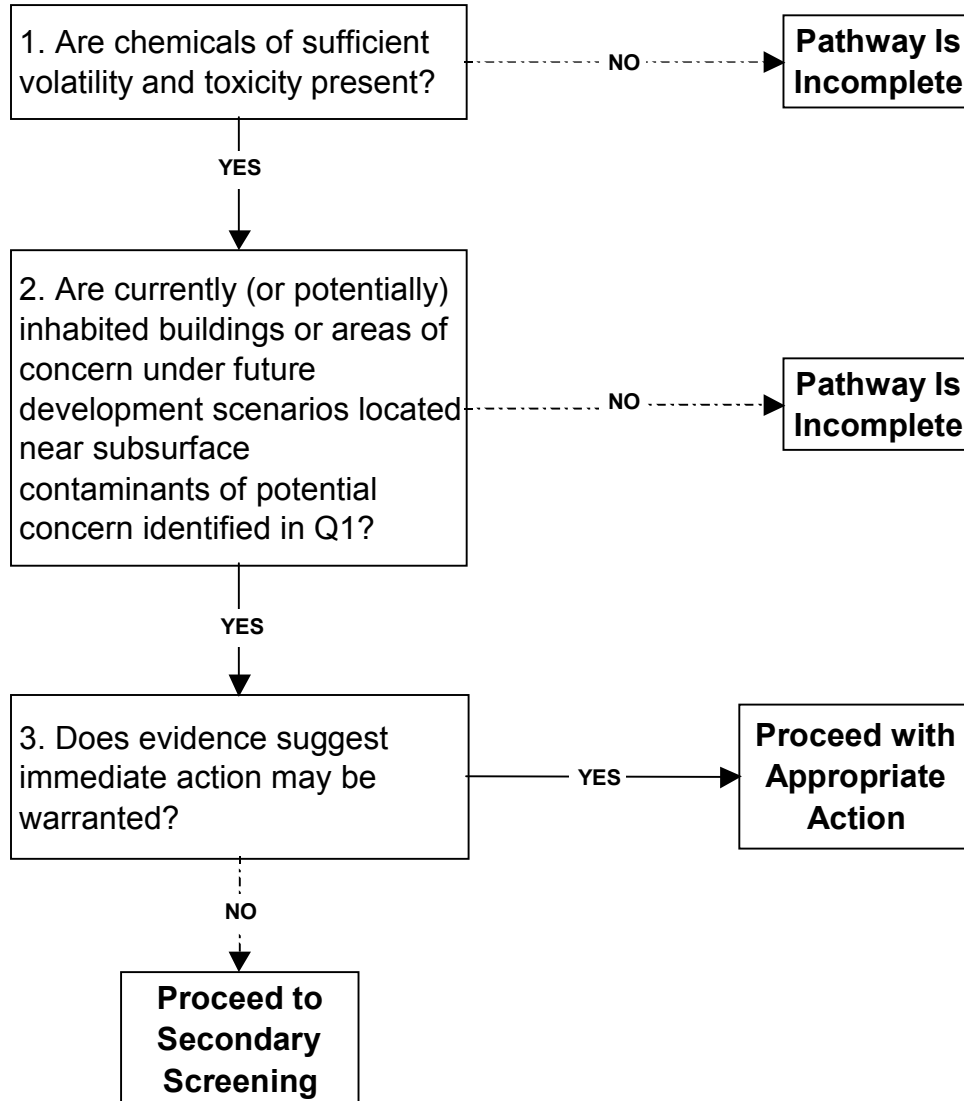

Figure B-1. Example of Conceptual Site Model cross section diagram illustrating potential subsurface vapor intrusion pathways

APPENDIX C

**DETAILED FLOW DIAGRAMS OF THE EVALUATION APPROACH
USED IN THE GUIDANCE**

PRIMARY SCREENING



SECONDARY SCREENING
Question 4 – Generic Screening
(TL = appropriate media specific target level)

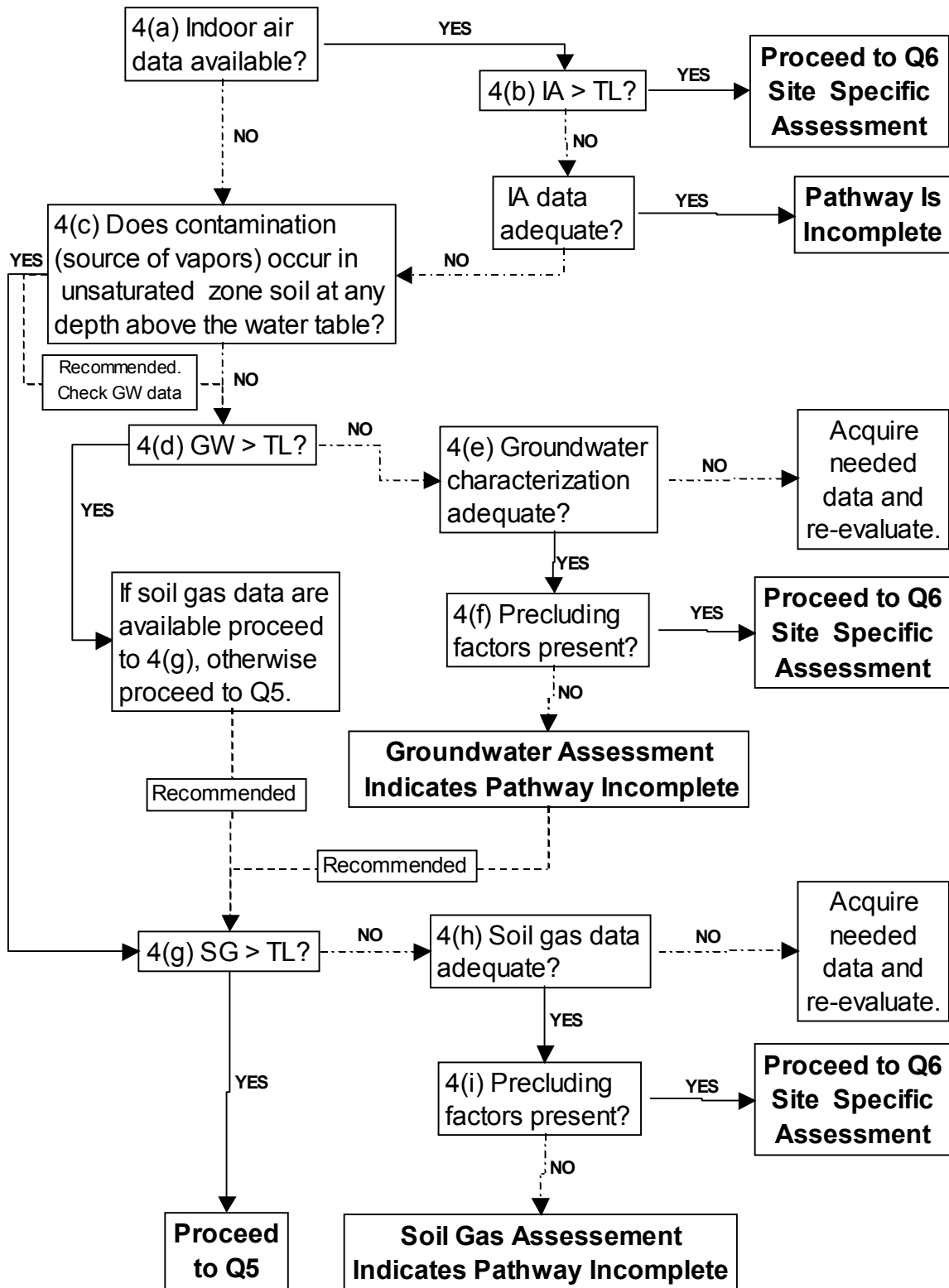

SECONDARY SCREENING

Question 5 – Semi-Site Specific Screening

(TL = appropriate media specific target level)

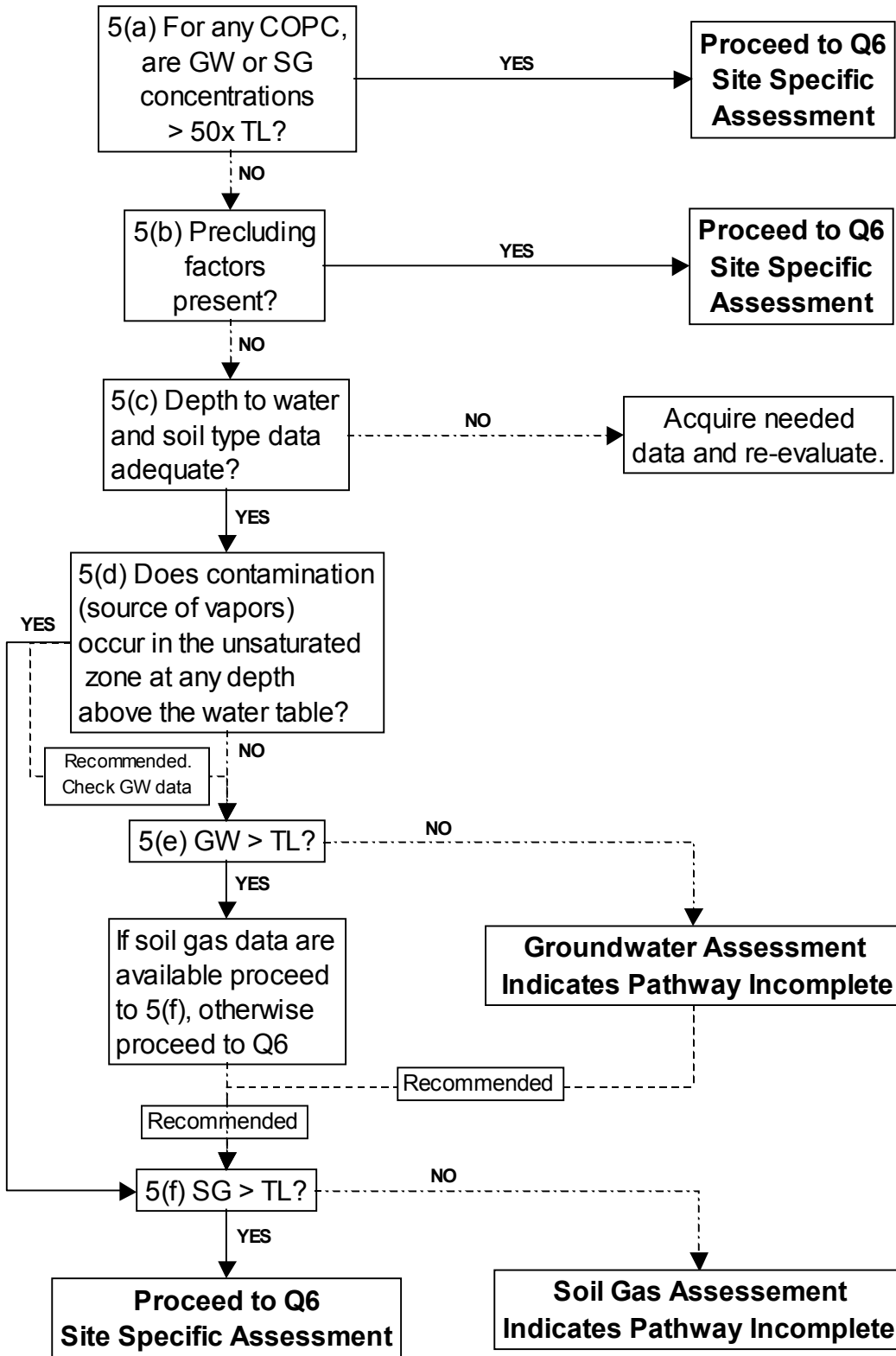

SITE SPECIFIC SCREENING

Question 6

(TL = appropriate media specific target level)

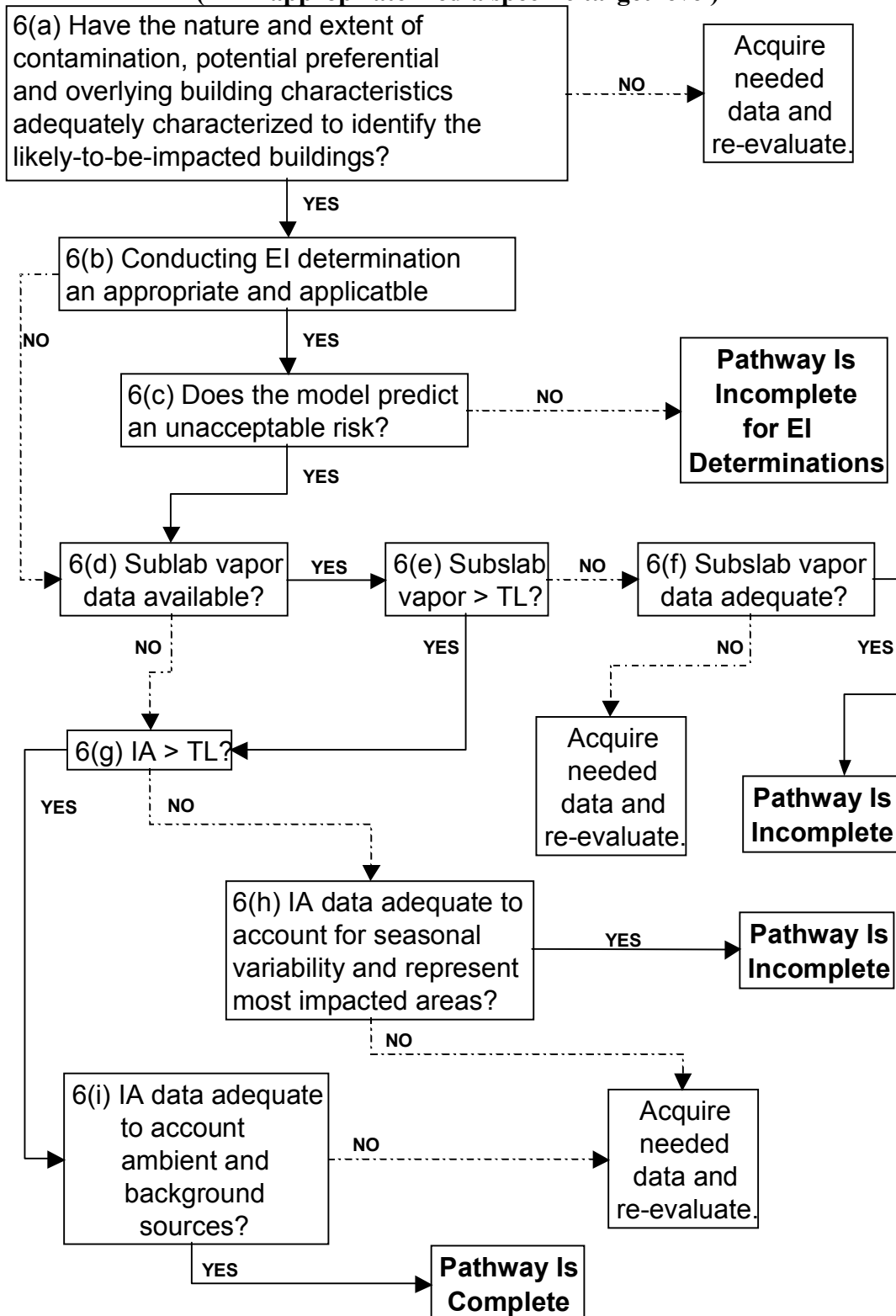

LaBELLA
LaBella Associates, P.C.

300 State Street
Rochester, New York 14614

Appendix 5

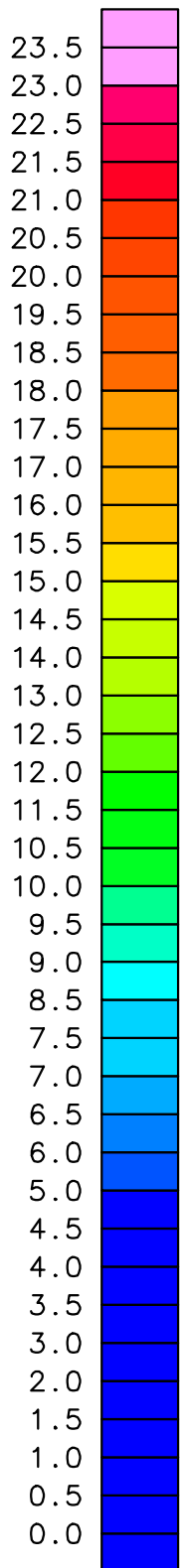
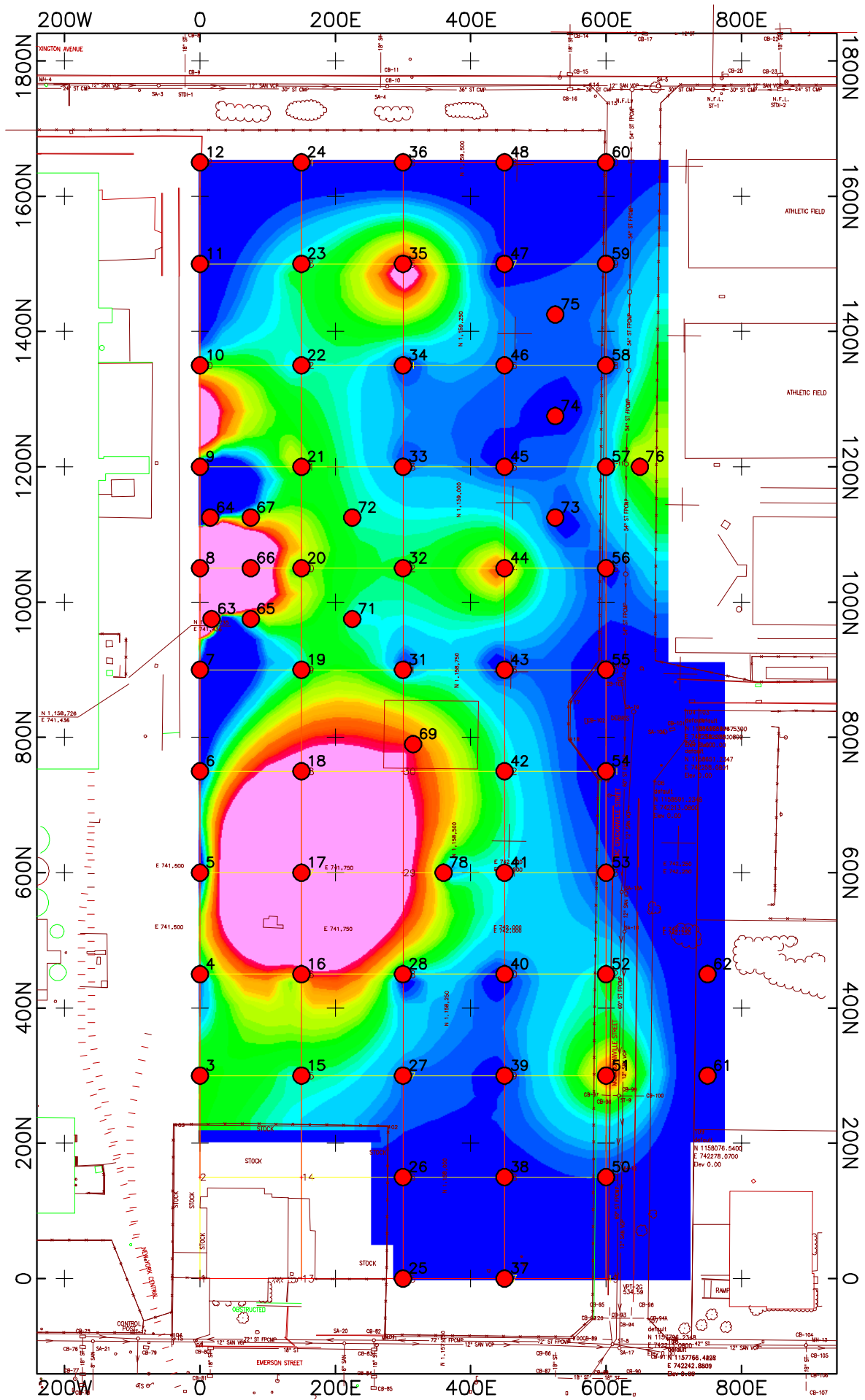

BTEX
(mg/m³)

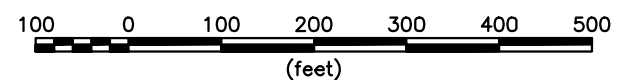
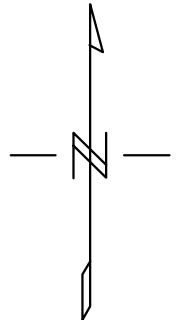
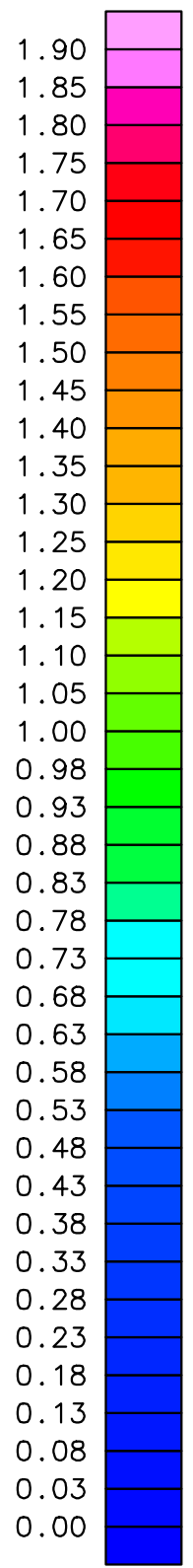
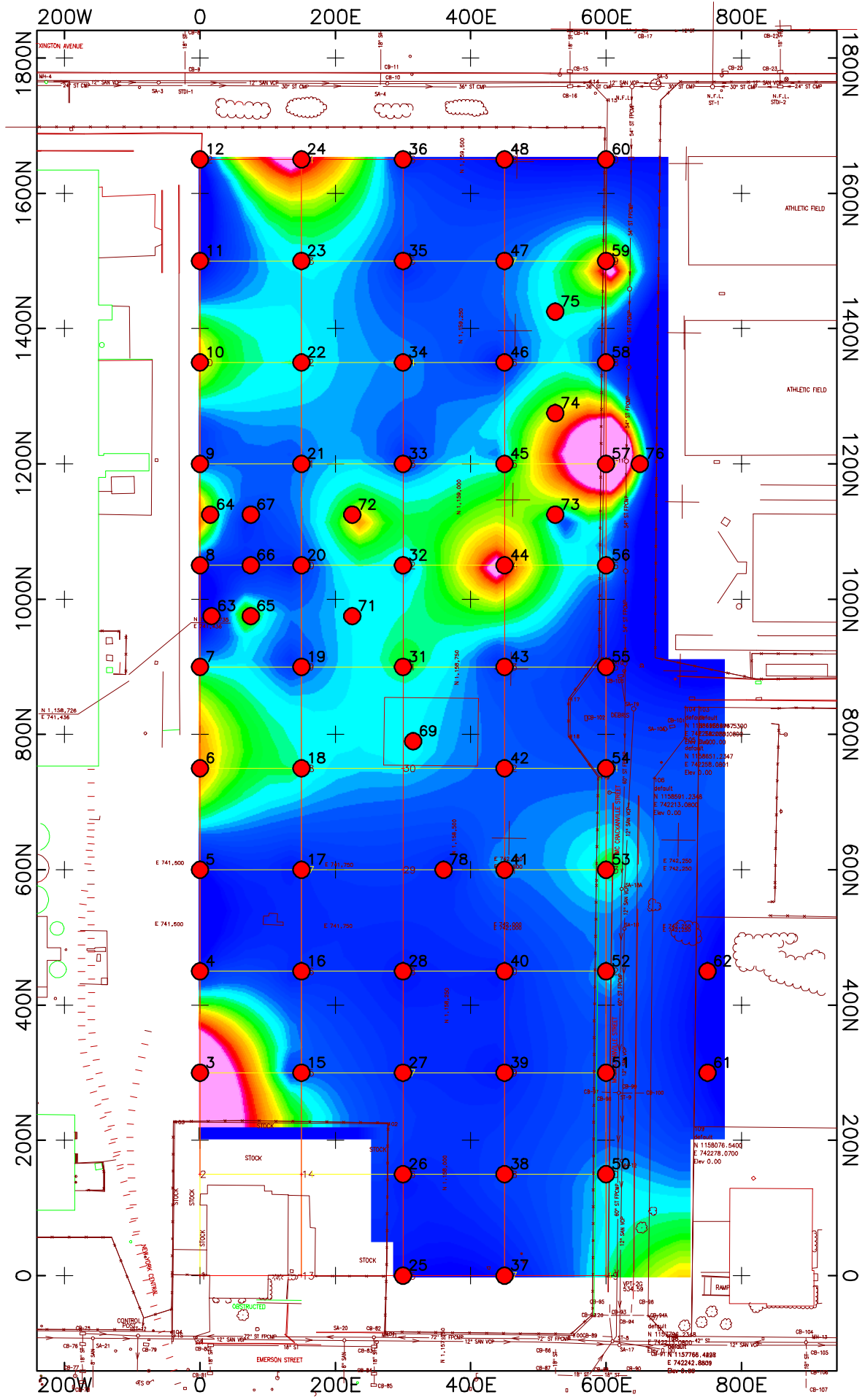

Figure 2
Soil Gas Survey Results
Emerson Street Landfill RI/FS
Rochester, NY

BTEX
(mg/m³)

Geomatrix Consultants, Inc.



Vinyl Chloride
(mg/m³)

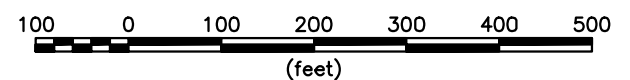
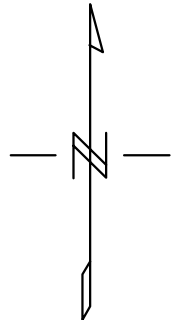
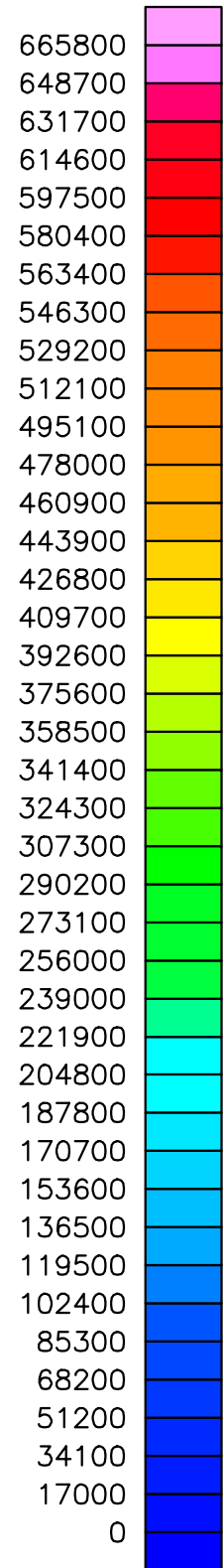
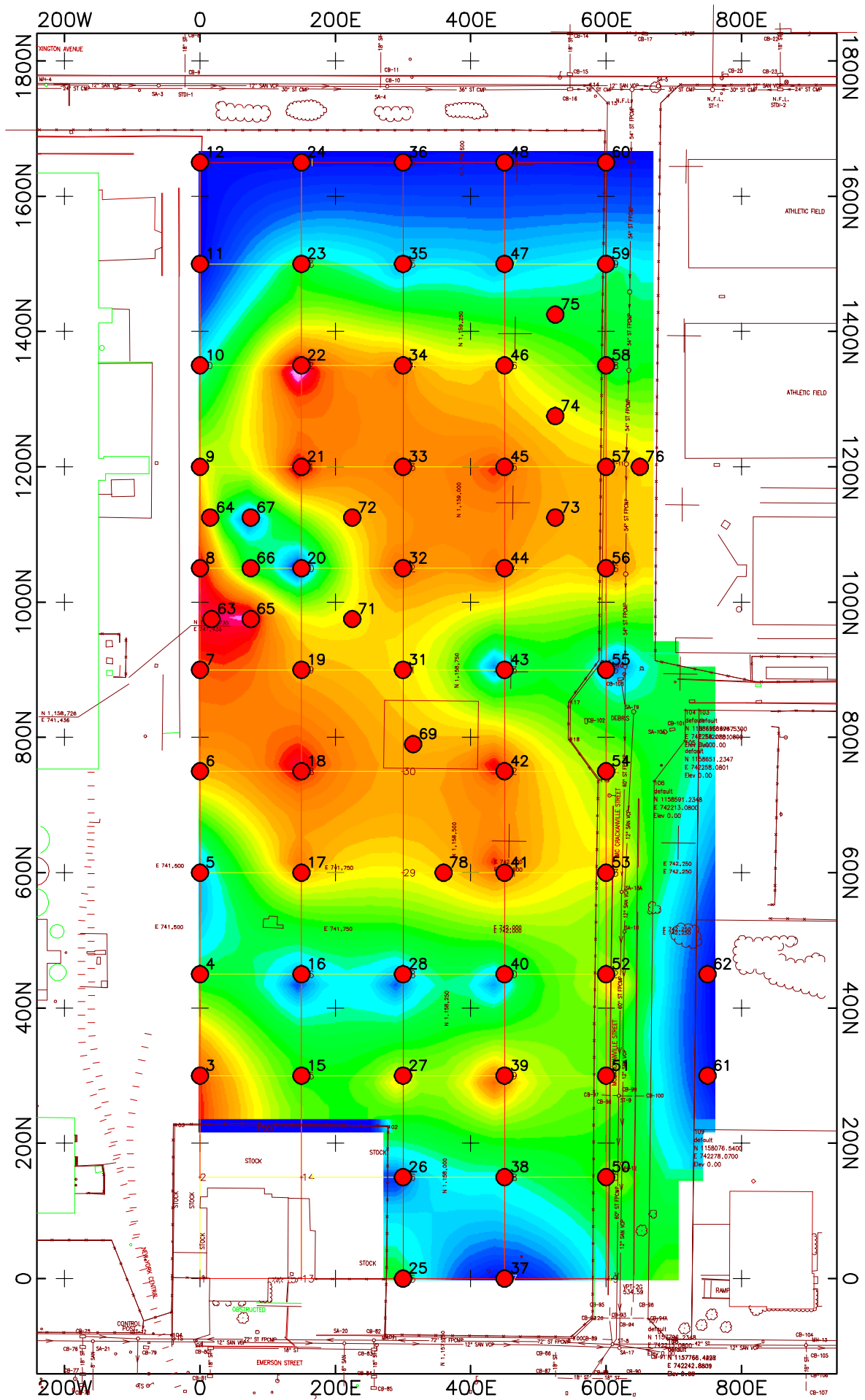

Figure 3
Soil Gas Survey Results
Emerson Street Landfill RI/FS
Rochester, NY
Vinyl Chloride
(mg/m³)
Geomatrix Consultants, Inc.



Methane
(ppm)

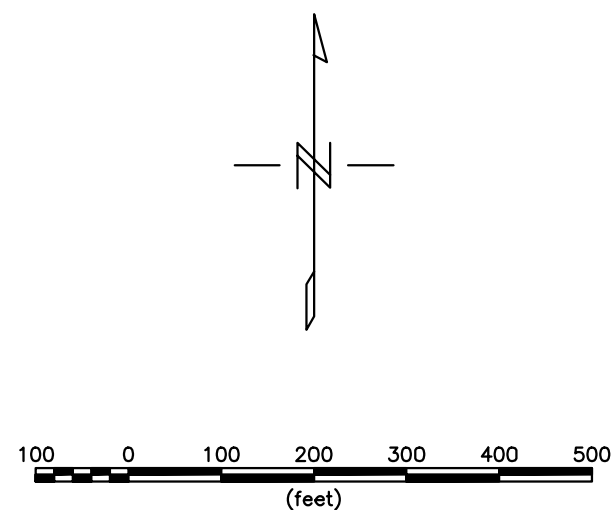

Figure 4
Soil Gas Survey Results
Emerson Street Landfill RI/FS
Rochester, NY

Methane
(ppm)

Geomatrix Consultants, Inc.

LaBELLA

LaBella Associates, P.C.

300 State Street

Rochester, New York 14614

Appendix 6

EXECUTIVE SUMMARY

This Soil Vapor Intrusion Assessment Report: Data Review, Site Screening and Site Prioritization (herein after referred to as the “SVI Report”) presents the initial phase of work for evaluating Soil Vapor Intrusion (SVI) due to historic landfilling activities at the 45 parcels located within the Former Emerson Street Landfill (FESL) footprint also referred to hereinafter as the “Site”. A portion of the Site (4 parcels) is listed as a Class 3 New York State Department of Environmental Conservation (NYSDEC) Inactive Hazardous Waste Disposal Site #828023 while the remaining parcels within the FESL have been de-listed. A Class 3 facility is defined as a facility where “contamination does not presently constitute a significant threat to public health or the environment”. Although a majority of the Site has been de-listed by the NYSDEC, the site is still on the list of ‘legacy’ sites maintained by NYSDEC all of which are being evaluated for SVI. A ‘legacy’ site is a site which has been identified by the NYSDEC, completed Remedial Investigation (RI) and remedy selection processes and is being evaluated for vapor intrusion. The City of Rochester entered into an Order-on-Consent with NYSDEC in August 2009 which initially required the development and implementation of an SVI assessment. This SVI Report fulfills this initial obligation and subsequent to review and approval by NYSDEC will serve as the basis for further work required at the Site.

This SVI Assessment by LaBella Associates, P.C. (LaBella) included a detailed review of historic information available for the Site which included not only previous subsurface environmental investigations but also a detailed review of aerial photography, subsurface data from redevelopment projects (e.g., geotechnical borings and test pits), available newspaper articles from the time the landfill was operating, and reports/papers relating to City of Rochester and Monroe County waste handling and disposal practices both historically and in particular in the 1960s/1970s. In addition, groundwater sampling of existing wells was completed, additional groundwater monitoring wells were installed, developed and sampled and a site reconnaissance was conducted at every parcel where access was granted by the property owner.

The historic document reviews provided detailed information on where filling operations were being conducted over the years and the anticipated types of fill materials both spatially and vertically throughout the landfill. This information was utilized during the groundwater investigations and the site reconnaissance work in order to evaluate the accuracy of the information (e.g., correlations between type of fill and methane generation). The historic information, subsurface testing and site reconnaissance results were utilized to develop a conceptual site model and this was utilized for determining the potential for SVI at each parcel due to the FESL. It should be noted that the historic information reviewed and actual site reconnaissance results correspond well overall, which allows for a higher degree of certainty with the conclusions and recommendations presented herein.

The City of Rochester developed a Property Owner Soil Vapor Intrusion Technical Assistance Program which included four (4) steps for working with property owners in order to assess, investigate, and mitigate VOCs/landfill gases associated with the Former Emerson Street Landfill. These four (4) steps included 1) an initial consultation with the property owner to discuss project scope and NYSDEC requirements, 2) an initial building survey (i.e., site reconnaissance) to evaluate for building conditions/factors that could impact SVI, 3) SVI investigation (if necessary), and 4) building mitigation (if necessary).

The site reconnaissance work included conducting an interview with a representative of the owner and/or tenant occupying the building and then conducting a detailed sampling of interior and exterior locations that would be the most probable SVI locations (e.g., cracks, holes in floor, support column floor penetrations, subsurface features (e.g., drain lines, sumps, etc.)). The site reconnaissance work was conducted by a team of consultants (Stantec, Day Environmental, Inc., Lu Engineers, and O'Brien & Gere) under the supervision of LaBella. A 'site summary' sheet along with the interview form, pictures and readings obtained from each site were provided to LaBella. LaBella met with each consultant and reviewed each property to evaluate the site reconnaissance work completed and discuss readings of interest obtained that may be related to SVI due to FESL.

The site reconnaissance work, groundwater sampling and filling information researched was input into a customized worksheet that ranked these various factors via a weighted scoring system which was used in part to rank and prioritize properties based on the potential for vapor or landfill gas intrusion associated with the FESL.

The significant findings for each of these activities are summarized below and discussed in greater detail in the main text of the report.

Historic Documentation Review

The aerial photography review indicated that landfilling operations appear to have initiated sometime after 1930 but prior to 1951. The West Side Incinerators located at 110-210 Colfax Street on the FESL were not constructed until 1954 and placed into operation in January 1955. Landfill materials brought to FESL prior to 1955 are most likely from the Falls Street Garbage Reduction Plant which appears to have operated until the West Side Incinerators began operation. It should be noted that the Falls Street Garbage Reduction Plant also incinerated municipal waste.

The 1958 and 1961 aerial photographs indicated disturbed areas (and thus assumed landfilling operations) generally south of Emerson Street, although some limited areas of disturbance are present north of Emerson Street. A 1964 aerial photograph (not reviewed directly by LaBella) and a 1966 aerial photograph are significant pieces of data for two reasons: 1) active landfilling appears limited to areas north of Emerson Street (whereas south of Emerson Street appears to be 'recovering'), with the exception of one 'lobe' of filling south of Emerson Street but east of Colfax in 1964; and, 2) additional information (discussed further below) indicates that the first indications of decreased incinerator efficiency began in late 1964 (fire reported in a newspaper article) with numerous sources of information indicated that the incinerators were not working well in 1968 and thereafter.

The decrease in incinerator efficiency appears to be a function of two variables. The first is a reported increase in incineration processing volume of approximately 29% in 1963-64 (based on the November 1965 Solid Waste Disposal Report for Monroe County, NY prepared by Nussbaumer, Clarke & Velzy Consulting Engineers) and the second is a reported need for maintenance and upgrades to the facility in the May 1970 Comprehensive Solid Waste Study Volume I & II prepared by Greeley and Hansen Engineers. The increase volume may not have contributed significantly to a decrease in efficiency since the 1965 Solid Waste Study Report also indicates that the facility was still under the design capacity. However, the first reported fire in 1964 may indicate that the increased capacity began to cause issues with the ability of the facility to completely combust the materials prior to landfilling. It would appear that as the plant aged, this become an increasing problem with numerous newspaper reports in 1968 citing

- ii -

issues with fires and potentially open dumping (i.e., dumping of unincinerated or partially incinerated waste) at the facility. By 1966 it appears that all landfilling activities were north of Emerson Street and materials landfilled around this time may not have been completely combusted or potentially direct burial was taking place. This point is important as, fully incinerated municipal waste should not generate methane gas due to the complete combustion of the waste; however, partially incinerated municipal waste or open dumping can generate methane gas upon decomposition.

This information indicates that methane gas issues should be generally limited to areas north of Emerson Street. It should also be noted that areas directly north of Emerson Street and in proximity to the street may have received ash material and not petrifiable waste. This is supported by test pit and test boring information from previous work completed at the Site. The ash material north of Emerson Street could be due to pre-1964 filling operations (as shown on the 1961 aerial photograph) and/or the spreading of ash material in proximity to Emerson Street in order to provide a visual and olfactory barrier at the time of spreading operations. The ash was also likely a better base material to drive trucks and equipment over, especially during wet periods. Regardless of the reason, the test borings and test pits advanced within approximately 250 ft. of Emerson Street indicated only ash materials.

In addition to potential methane issues, the historic filling research also provided several other significant pieces of information in relation to potential landfilling of liquid waste and incinerator operations. Specifically, a July 7, 1969 City of Rochester Inter-Departmental Correspondence refers to the writer's review of the preliminary Comprehensive Solid Waste Study report by Greeley and Hansen which indicated that liquid waste disposal in the County includes disposal in landfills and illegal discharges to sewer systems. However, it appears that the City was not practicing such disposal at landfills since the memo goes on to request that Greeley and Hansen provide further information in the final report that details how to handle such liquids in this manner. Based on this it appears that the City was not allowing disposal of liquid waste in landfills as late as July 1969 and probably more likely after the final report, which appears to have been issued in May 1970 at which time the landfilling activities are limited to northwest portion. It is assumed that any burial of liquid waste would have been conducted after this date. It should also be noted that a 1970 earth cover contract included placing cover material over the northeastern portion of the landfill and a newspaper article from November 28, 1970 included an aerial photograph which shows the area as covered. Furthermore a hand drawing indicated the 1970 'working area' (assumed to mean active landfilling) was limited to the northern central portion of the FESL north of Emerson Street. Based on this information it appears that if active liquid waste disposal occurred at the FESL it was limited to the northern and western portion of the FESL north of Emerson Street. This corresponds with the P-1 area as potentially being an FESL related release; however, there are two other relatively minor (in comparison to P-1 based on the current data) plumes that would appear to be due to post FESL activities. Additional information on this is included with the groundwater discussion.

Groundwater Evaluation

Groundwater evaluations at the FESL have been conducted since 1988 and have included the installation and sampling of 44 wells. In addition, this SVI Assessment also included the installation, development and sampling of an additional nine wells. The cumulative results of these efforts has indicated that there are three distinct chlorinated VOC (CVOC) plumes at the FESL. As discussed above, one of these plumes (P-1 Plume) appears attributable to historic filling operations or possibly due to unregulated filling after closure of the FESL. The other two CVOC plumes appear likely due to post landfill activities involving manufacturing operations in the area (i.e., GW-7R and GW-9). This appears to be the case due to the following factors:

- iii -

Executive Summary
Soil Vapor Intrusion Assessment Report
Former Emerson Street Landfill, Rochester, New York
LaBella Project No. 210173

LABELLA

- Both plumes show increasing CVOC trends compared to the P-1 plume.
- Both plumes do not appear to be associated with the P-1 plume based on non-detect levels in wells located between the two plumes and the P-1 plume, and the groundwater flow direction.
- The GW-9 area would appear to have been filled prior to 1966 when the incinerators were working efficiently and direct burial was likely not being conducted.
- The GW-9 area is located hydraulically downgradient of four manufacturing operations with histories of metal working operations. The buildings in this area were constructed between 1966 and 1973 and thus it is likely that one or all of these operations utilized chlorinated solvents as part of their operations.
- GW-7R is located hydraulically downgradient from a building built in 1985 and utilized for metal fabrication.

Based on the apparent post FESL nature of the GW-7R and GW-9 plumes and the requirements of the Order-on-Consent, it does not appear that these plumes are the responsibility of the City of Rochester and thus these plumes are not included in ranking properties/buildings in proximity to these areas.

FESL P-1 Plume Area

The P-1 Plume area is generally defined and significantly influenced by the storm sewer system that runs through McCrackanville Street, west down Emerson Street and then south parallel to (but west of) 'W' Street and eventually to an outfall into the Barge Canal. This sewer was installed (reportedly by blasting) into the bedrock in order to obtain the proper drainage slope and the bedding and bedrock fracture network appears to be significantly influencing the direction of groundwater flow and thus a CVOC migration pathway. The influence of the sewer system on groundwater flow was previously documented in the 2001 Geomatrix/LaBella report and additionally by a site-wide collection of groundwater elevations in December 2010. The December 2010 groundwater elevations were compared to the sewer inverts and indicated steep gradients in proximity to sewers where the invert is at or below the interpolated groundwater elevation. This results in groundwater flows on both sides of the storm sewer piping/bedding flowing towards the sewer.

The groundwater sampling data confirms the sewer influence on groundwater flow and thus contaminant migration. These two significant pieces of data were used to develop a conceptual model of the P-1 Plume area and this is illustrated on Figure 14. As shown the highest concentrations are around P-1 which is assumed to be in proximity to the actual source of CVOCs. The plume extends to the south and southeast towards McCrackanville Street which is consistent with elevated detections in wells in this location (GMX-MW-3 and GMX-MW-6S). CVOCs are detected in wells east and southwest of P-1; however, these concentrations are significantly lower and thus some diffusion/dispersion of contaminants is likely occurring cross-gradient of groundwater flow; however, this is only relatively minor in concentration. A monitoring well directly east of the McCrackanville Street storm sewer indicated significantly lower concentrations than a well on the west side of the sewer. Additionally, a well installed approximately 150 feet east of the storm sewer did not detect any VOCs. Within Emerson Street and near McCrackanville Street, groundwater flows towards the sewer from the north and south and appears to move toward the west in the downgradient direction of the storm sewer. Groundwater impacts south of Emerson Street are significantly lower than north of Emerson

Street; however, are still present at concentrations above the NYSDEC TOGS 1.1.1 groundwater standards. A monitoring well approximately 800 feet south of Emerson Street (in the VanGaurd Parkway Right of Way) was non-detect for CVOCs. The groundwater plume appears to extend to the west slightly beyond W Street. Although additional wells were not installed south of the intersection of W Street and Emerson Street, it is not anticipated that significant impacts extend south and impacts that do extend in this direction are likely limited to in direct proximity of the storm sewer.

Site Reconnaissance

In preparation of the site reconnaissance, available records and historic information was reviewed in order to have an understanding of current and former operations/locations at the Site. This information was used to confirm operations at the time of the site visit. The historic information review and site reconnaissance information indicated that all properties but three have moderate to heavy use of VOCs for their operations (petroleum storage, parts washers, solvents, paints, etc.). The three exception to this are 1727-1755 Emerson Street (RG&E substation), 480 Ferrano Street (American Tower Systems radio tower) and 1555 Emerson Street (GBH Family Corp – warehouse and distribution); however, even these properties had some minor form of VOC use (bug spray can, printer inks, etc.). It should also be noted that a majority of the properties also were documented (i.e., fire department records, permits, etc.) or highly suspected (i.e., machine shops, metal fabrication, chemical packaging, waste handling, etc.) to have had chlorinated solvent use in the past.

The use of VOCs at each occupied property resulted in the need to differentiate between VOCs due to current or former operations and VOCs potentially due to a subsurface source of VOCs which may or may not be associated with the FESL. In order to differentiate between these two potential causes of VOCs, a detailed evaluation was conducted that included noting operations in the area and VOC emissions due to those operations. Specifically, background/operational VOC readings were recorded throughout each facility in order to be able to evaluate readings obtained from cracks and floor penetrations. For a majority of the facilities, VOC readings would decrease as the meter was brought down from the breathing zone and to the floor, crack, or other penetration through the slab. In these instances, the reading was deemed to be below background and thus not considered a reading of concern for SVI. One exception to this was readings that were collected from locations that were clearly in communication with the subsurface (e.g., holes in floors or passive vent system piping, etc.). In locations where the reading increased, possible on-site operations were evaluated and if present (e.g., dense vapors migrating along the floor from an operation or actively used trench drain), the reading was not considered to be due to SVI. In the event that a reading was noted to be above the apparent operational/background VOC reading, then this reading was identified as a PID reading of interest.

LaBella reviewed each summary completed for the properties on the FESL and evaluated each of the readings of interest in comparison to the groundwater conceptual model, fill progression, and type/location of fill materials. This evaluation resulted in an opinion on if a PID reading of interest was due to the FESL or if such readings were likely due to historic private operations at that property (e.g., solvent use, USTs, etc.).

Methane readings were generally considered due to FESL with the exception of methane readings obtained from sewer manholes/vaults or deemed to be naturally occurring methane from a thermogenic source (three deep wells installed within the Rochester Shale Formation) where laboratory testing confirmed methane readings were due to a thermogenic source.

- v -

Executive Summary
Soil Vapor Intrusion Assessment Report
Former Emerson Street Landfill, Rochester, New York
LaBella Project No. 210173

LABELLA

Methane Evaluation

LaBella performed methane testing on groundwater monitoring well MW-15D (located at 1769 Emerson Street) in order to determine the source of elevated methane concentrations in this well (i.e., >65% on the Landtec GEM 2000 field meter). A representative gas sample was collected from MW-15D and from a soil gas point from a location known to have methane gas due to FESL in order to evaluate the source of the gas (i.e., pipeline gas source, thermogenic source (naturally occurring gas deposit), or landfill gas source). The samples were analyzed for compositional analysis (methane, ethane, butane, propane) and isotope analysis of methane and carbon dioxide. Sample results indicated that the gas identified in MW-15D is generated from thermogenic processes and thus is a naturally occurring gas deposit that MW-15D is venting. This also appears to be the case for DEC-MW-18 and DEC-MW-20 which also appear to be installed at similar or greater depths.

Prioritizations

The results of the cumulative work were utilized in a ranking system that use weighted numerous criteria for each building. The criteria can be separated in to two major categories, Non-FESL related factors and FESL related factors:

Non-FESL Factors:

- Building Use Factors – these factors include how many people generally occupy the building on a daily basis and the type of use/potential receptor population (e.g., sensitive receptors like children). It should be noted that these factors increase the concern for SVI; however, these factors do not increase the potential for SVI and specifically SVI due to FESL.
- Building Condition Factors – these factors include the type of building and foundation construction (e.g., slab-on-grade, caisson and grade beam, basement, crawl space), condition of the floor slab (e.g., presence of cracking, sealants, number/type of floor penetrations), and heating, ventilation and air conditioning (HVAC) systems related to building pressurization. These factors can increase the potential for SVI; however, it should be noted that a subsurface source of VOCs must be present for these factors to be of concern.

FESL Related Factors

- Building Location Factors – these factors include where on the FESL the building is located and specifically in relation to the P-1 plume area (i.e., an increased potential for SVI of VOCs due to FESL) and/or if the building is located over pre or post-1964 landfilling operations (i.e., an increased potential for SVI of landfill gases). These factors increase the potential for SVI specifically due to FESL. Increased potential for SVI landfill gas such as methane is of concern due to the characteristics of methane which include the following:
 - Explosive range of 5% to 15%;
 - Methane can be carried under pressure into overlying buildings and can also carry other VOCs with it; and
 - At a high enough concentration, methane could displace oxygen and create an unsafe condition.

- Site Reconnaissance Readings – this category does not account for all readings collected at the Site. Rather, this category only accounts for readings that could not be attributed to current or in some cases, former site operations and thus appeared to be due to FESL. Since these readings may represent actual SVI occurring, each instance of a reading above background was included in the weighting sheet (i.e., multiple readings were included multiple times).

The above weighting/prioritization work resulted in developing three scores for each property: 1) FESL related factors score, 2) Non-FESL related factors score, and 3) overall prioritization score. The overall scores were separated into three “Tiers” of sites. Tier 1 sites were determined to be of the highest concern for SVI due to the FESL, Tier 2 sites were determined to be of moderate to low concern for SVI due to the FESL and Tier 3 sites were determined to be of low to no concern for SVI due to FESL. Based on this work, Table 7 indicates the prioritization of sites. In addition, Tables 8 through 10 provide a brief summary of the results and recommendations for any further work to be conducted. A summary of the results and general recommendations are below. This is further defined below and in Section 6.4.

- **Tier 1 Properties** - Nine (9) buildings are considered Tier 1 buildings. This represents approximately 21% of the building space with an estimated total of 400,985 ft². These properties are all in proximity to the inferred extent of the P-1 plume area and generally scored higher on FESL related factors (range between -2 and 12) and received the highest overall prioritization scores. As such, these buildings appear to be at a higher risk for SVI due to the FESL. All but one of these are recommended for additional work (either mitigation or further investigation). The one property not recommended for additional work is an open air, during operations (i.e., occupancy) transfer station that is not heated and as such the potential for exposure is minor (additionally, this building also scored the lowest of the Tier 1 properties for FESL related factors).
- **Tier 2 properties** – Thirteen (13) buildings are considered Tier 2 buildings. This represents approximately 27% of the building space with an estimated 503,239 ft². These properties generally scored lower on the FESL related factors; however, their Non-FESL factors (occupancy, use, building characteristics) scored high. As such, the overall prioritization score for these properties fell within Tier 2. However, these properties, with the exception of one, appear to be low to no risk of SVI due to FESL and as such, all but two (2) of the buildings are recommended for no additional work. The two buildings recommended for additional work are associated with Edison Technical School which has air handling equipment in the basement that could be utilized for an added measure of safety and as such is recommended for additional work.
- **Tier 3 properties** – Eighteen (18) buildings are considered Tier 3 buildings. This represents approximately 49% of the building space with an estimated 924,648 ft². These properties generally scored lowest on the FESL related factors and also scored lower on the Non-FESL factors. As such, the overall prioritization score for these properties were low and they appear to have low to no risk of SVI due to FESL. Based on this, only one of the Tier 3 buildings are recommended for additional work. The one building recommended for additional work detected methane during the site reconnaissance. However, the floor was subsequently sealed and a follow up monitoring event did not detect methane. The further work recommended is to conduct two (2) more rounds of follow up monitoring to confirm the results. It should be noted that the ranking of this property used the post sealing testing results.

In addition to the above, there were also several properties that were determined to be vacant, undeveloped, buildings not designed for occupancy, already effectively mitigated and one property where access was not granted. These are also summarized below:

- **Vacant/Undeveloped Lands** – Ten (10) properties were determined to be vacant or undeveloped lands. The City of Rochester owns six of these parcels (5 of which are part of the IHWDS). The other 4 are privately owned and either parking lot areas (DeCarolis Truck Parking – 3 properties) and one undeveloped land (partially a wetland, 180 Ferrano Street).
- **Unoccupied Buildings** – Eight (8) buildings were determined to be not designed for occupancy. This represents approximately 0.4% of the building space with an estimated 6,874 ft². These buildings were generally storage shed, warehouse space, an RG&E substation, and 5 buildings were associated with the Radio Tower at 480 Ferrano Street. These buildings are infrequently utilized and do not have regular occupants (generally occupied once a week for one hour). Based on this these buildings do not appear to warrant any further work.
- **Buildings with active SSDS In-Place** – Two (2) buildings have an active sub-slab depressurization system (SSDS) in-place and micro-manometer readings of monitoring points indicated adequate sub-slab depressurization was occurring (generally greater than 0.02 inches of water column). Based on this no further work appears warranted with these buildings. This represents approximately 2% of the building space with an estimated 32,448 ft².

City of Rochester Institutional Controls

The recommendations made for each of these properties take into account the existing Institutional Controls the City of Rochester has in place. The City of Rochester has a flagging system which requires any property requesting a permit to include a review by the City of Rochester Department of Environmental Quality (DEQ). This control is one check that will allow future changes in occupancy/use or building characteristics to be evaluated by the City which could affect the overall prioritization score.

LABELLA
LaBella Associates, P.C.

300 State Street
Rochester, New York 14614

Appendix 7

**FORMER EMERSON STREET LANDFILL
SUB-SLAB VENTILATION GUIDANCE DOCUMENT
ROCHESTER, NEW YORK**

by

**Haley & Aldrich of New York
Rochester, New York**

for

**City of Rochester - Department of Environmental Services
Rochester, New York**

**File No. 70007-061
May 2000**

FORMER EMERSON STREET LANDFILL SUB-SLAB VENTILATION GUIDANCE DOCUMENT

1.0 INTRODUCTION

This guidance document was developed to assist the City of Rochester with design guidance of sub-slab ventilation (or landfill gas abatement) systems in buildings constructed over solid waste and/or ash contained within the Former Emerson Street Landfill (FESL). This document was produced in response to the Monroe County Department of Health (MCDOH) concerns regarding the possibility of landfill gases seeping into the sub-slab portions of such buildings.

Previous FESL investigations have correlated historical information regarding the variable composition of the landfill and ground surface gas flux measurements at specific locations. In this letter, a methodology for selecting an appropriate ventilation system is described that is dependent on landfill gas measurement in the geographic location of the proposed building (with respect to the footprint of the FESL), and the type of foundation of the building. In general, a more robust ventilation system is recommended in areas of higher historical landfill gas flux measurements.

This guidance document contains the following:

- Landfill gas flux information for the FESL.
- Description of system conceptual design.
- Conceptual design drawing with example system details
- Recommendations for installation and maintenance.

2.0 LANDFILL GAS FLUX INFORMATION

The report "Former Emerson Street Landfill, Modified Remedial Investigation", H&A of New York, January 1994, contains applicable landfill gas flux information. During this investigation, landfill gas measurements were obtained across the landfill area with specially-designed gas flux chambers. As summarized in the report, landfill gas is typically composed of 58% methane, 42% carbon dioxide, and trace amounts of hydrogen sulfide and other organic compounds. Methane emission rates varied in the FESL samples from a minimum of 7.8 to a maximum of 1200 $\mu\text{g}/\text{m}^2\text{-minute}$.

The areas in the vicinity of the FESL can be separated into four general geographic regions (FESL Quadrants) based on landfill waste composition and historic landfill gas flux measurements. The composition of the landfill will likely impact the type of building design that will be developed. In other words, buildings constructed over areas of high non-ash, potentially putrescible solid waste will more likely have pier or caisson-style foundations to provide structural stability, and this type of foundation does not allow easy implementation of an impermeable vapor-barrier type system. Conversely, a slab on grade foundation is more amenable to implementation of a system utilizing a vapor barrier.

Figure 1 and Tables 1 and 2 summarize landfill gas flux measurements for the four FESL Quadrants (A-D). These measurements were then converted into cubic feet per minute per 1000 square feet of building, see Table 2. An example conversion calculation is also shown on Table 2. The approximate gas flux expected for a building can be calculated by knowing the geographic location (FESL Quadrant) and the square footage of the building.

The characteristics of the FESL Quadrants are summarized below:

Quadrants A and B (North of Emerson Street):

Landfill Characteristics - Thicker fill, higher percentage of potentially putrescible solid waste and less incinerated ash, higher landfill gas flux at surface relative to other FESL areas sampled.

Foundation Type - Higher potential to require piers, caissons, or similar foundations due to potential for settling.

The main distinction between Quadrants A and B is the relative level of gas flux measured in past sampling. Quadrant A tends to have lower flux (less than 50 ug/m²-min) than Quadrant B (greater than 100 ug/m²-min). This may be related to a thicker mass of putrescible waste in Quadrant B.

Quadrants C and D (South of Emerson Street):

Landfill Characteristics - Thinner fill, lower percentage of potentially putrescible solid waste and more incinerated ash, lower landfill gas flux at surface relative to other FESL areas sampled.

Foundation Type - Higher potential for slab on grade foundation style.

The main distinction between Quadrants C and D is the relative level of gas flux measured in past sampling. Quadrant C tends to have lower flux (less than 50 ug/m²-min) than Quadrant D (greater than 50 ug/m²-min). This may be related to the presence of organic rich marsh-derived soils at depth, east of Colfax Street.

3.0 DESCRIPTION OF VENTILATION SYSTEMS

Based on the geographic locations and foundation designs described above, H&A recommends the ventilation system be one of two following types:

Type I System consists of an impermeable vapor barrier of 20 mil polyethylene sheeting that inhibits migration of landfill gases through the sub-slab and into the building combined with sub-slab vent pipes that provide a minimal amount of venting of the landfill gas to the exterior of the building. Crushed stone should be placed above and below the piping network, and will act as a higher permeability zone through which the gases can migrate to the piping. A geotextile material will be placed both above and below the sheeting for protection.

Type II System consists of a crushed stone sub-base with a network of air intake and exhaust piping to ventilate the sub-slab area. Then exhaust piping will terminate at the building roof with a turbine fan to provide additional venting potential. Crushed stone should be placed above and below the piping network, and will act as a higher permeability zone through which the gases can migrate to the exhaust piping.

The Type I system is only appropriate if the foundation is a slab on grade type. Implementation of a polyethylene vapor barrier is not feasible if the foundation utilizes caissons or piers due to the difficulty of providing adequate seals around the caisson/pier intrusions.

Due to our past experience with investigations at the FESL, it is H&A's recommendation that if a building is to be constructed north of Emerson Street (Quadrants A and B) the system should be Type II with a turbine exhaust ventilation piping network regardless of the foundation type. If a building is to be constructed south of Emerson Street (Quadrants C and D) and has a slab on grade foundation, then a Type I ventilation system may be appropriate. If a building is to be constructed South of Emerson Street (Quadrants C and D) and has a caisson foundation, a Type II system is more appropriate.

Example building layouts and construction details are located on the attached Drawing SV-1. For the Type I system, the air intakes should be located on the sides of the building near ground level and the exhaust should be located on the opposite side of the building just above the roofline. The elevation difference between intake and exhaust is intended to cause a natural draft resulting from stack-effect. Wind-driven turbines should be installed at the exhaust pipe discharge to induce additional exhaust.

For the Type II system, air intakes should be located on the sides of the buildings near ground level and exhaust turbines should be located on the roof. Again, the elevation difference between the air intake and exhaust points will take advantage of natural draft resulting from stack-effect. Wind-driven turbines should be installed at the exhaust pipe discharge to induce additional exhaust capacity.

According to the National Weather Service, Rochester's average wind speed is 12.5 mph. The 8 inch diameter turbines recommended on the attached detail are rated at 255 cfm under a nominal 4 mph wind (with no back pressure). The turbines are intended to maintain an adequate flow for ventilation even with the addition of back pressure associated with the sub-slab piping. Details of intake and exhaust points are shown on the attached Drawing SV-1. A piping layout for an example ventilation system is included on the attached Drawing SV-1. The configuration of the intake and exhaust piping network will vary due to each building's unique design.

Contact was made with Sabrina Sanderson of the NYSDEC Air Division regarding the need for air emission permits. The NYSDEC representative indicated there are no requirements for air emission permits for sub-slab ventilation systems on buildings built on top of closed landfills.

4.0 RECOMMENDATIONS FOR INSTALLATION AND MAINTENANCE

Type I system recommendations:

- Design the layout of the piping so that the spacing between each piping length is approximately 50 feet.
- Install the exhaust end of the piping on the exterior building wall as near to the roofline as feasible to maximize the stack effect.

Type II system recommendations:

- Alternate the intake and exhaust piping (see attached figure).
- Design the layout of the piping so that the spacing between each intake and exhaust

- piping length is approximately 20 feet.
- Provide vertical exhausts to the roof turbine at intervals of approximately 150 to 200 feet along the horizontal exhaust piping.

General recommendations:

- Avoid sharp items (e.g. larger stones, rebar) that could damage the integrity of the vapor barrier or piping, as appropriate.
- Adjust the location of an air intake if it is near any other air emission source (e.g. loading dock, exhaust vents), as appropriate.
- Install "NO SMOKING" signs near air intake locations and ensure smoking does not occur near these intakes.

System maintenance recommendations:

- Clear snow from air intakes, as required and appropriate.
- Inspect external portions of the systems, particularly the turbines, monthly to evaluate piping integrity.
- Inspect turbines monthly to ensure they are rotating properly and are securely mounted.
- Inspect inlet and exhaust points monthly to ensure they haven't become plugged or blocked. Inspect more frequently in winter to ensure intake/exhaust points are not clogged by snow or ice.
- Perform other maintenance activities as specified by manufacturer of installed equipment.

Attachments:

Table 1	Summary of Methane Emission Rate Calculations (from previous H&A report)
Table 2	Example Gas Flux Calculation and Summary Table
Figure 1	Estimated Landfill Cover Thickness and Gas Sampling Locations (from previous H&A report)
Drawing SV-1	Sub-Slab Ventilation System Plan and Details

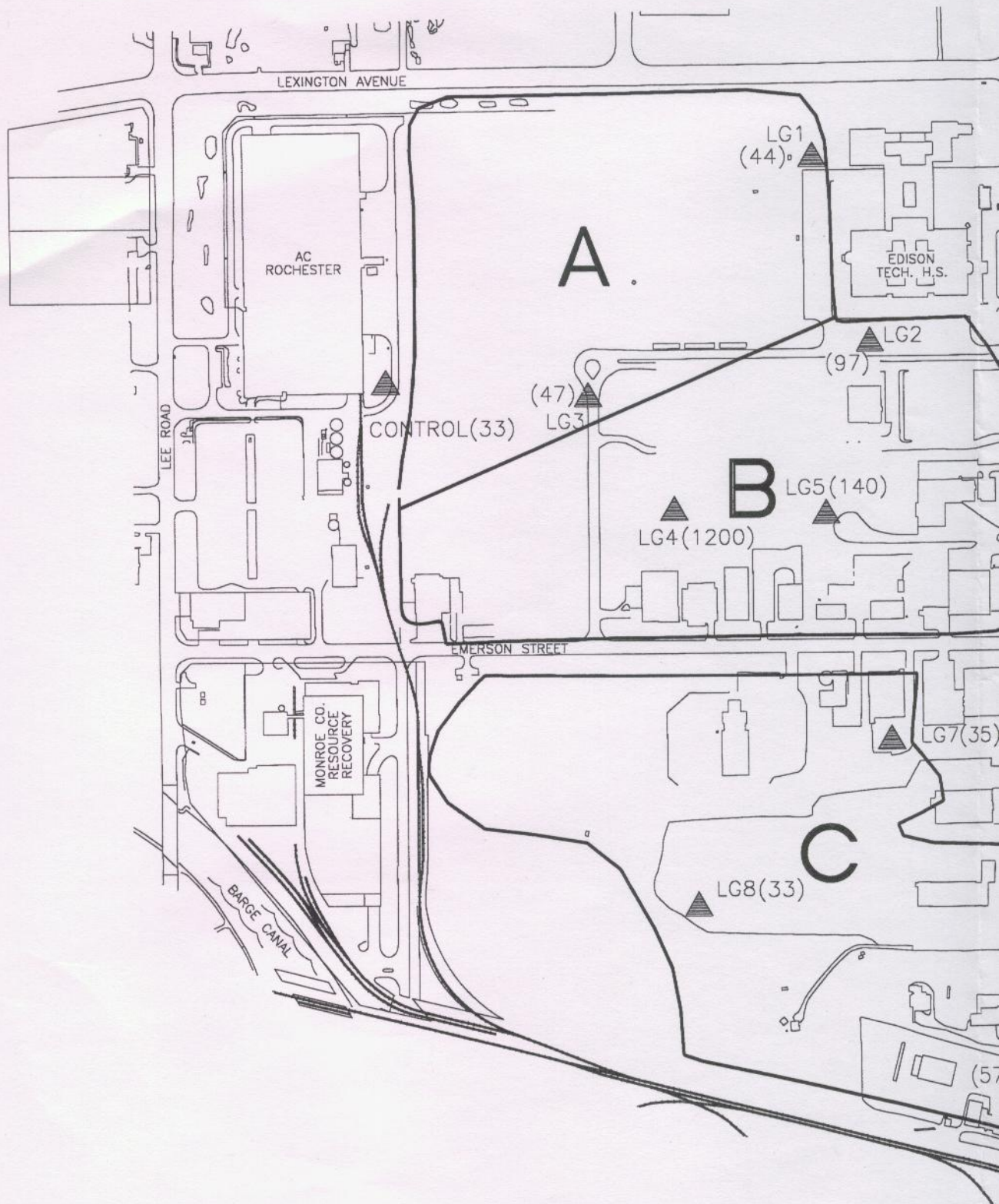

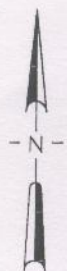
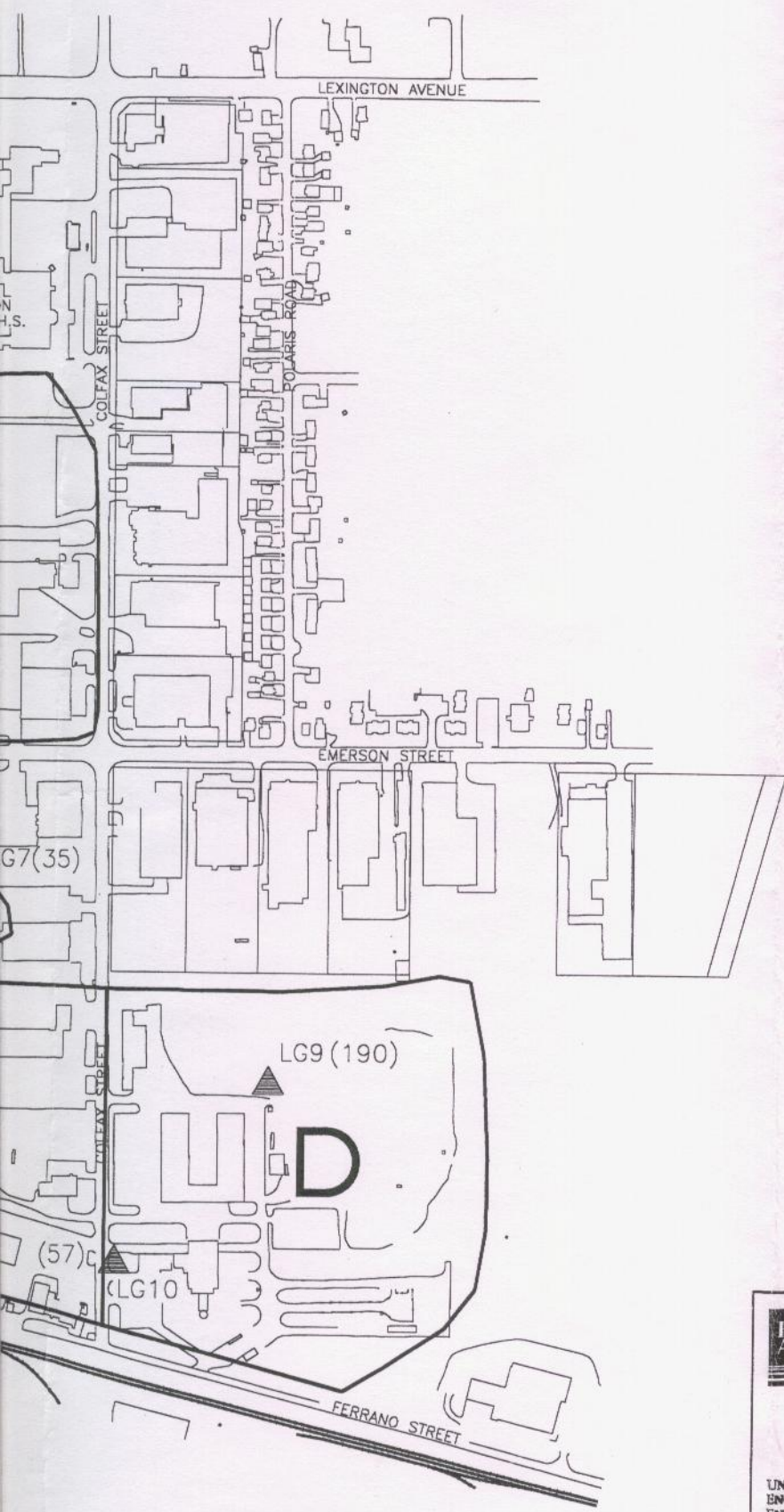

LEGEND:

- ▲ LG1 LANDFILL GAS SAMPLING LOCATION
- Ⓐ FESL QUADRANTS (A-D) SEE NOTE BELOW
- (33) METHANE EMISSION RATE (ug/m²-min) AS REPORTED IN "FORMER EMERSON STREET LANDFILL, MODIFIED REMEDIAL INVESTIGATION" H&A OF NEW YORK, JANUARY 1994.

NOTE:
 THE FESL EMISSION QUADRANTS (A-D) WERE IDENTIFIED BASED ON SURFACE LANDFILL GAS FLUX MEASUREMENTS AND THE COMPOSITION OF THE LANDFILL DEPOSITS.

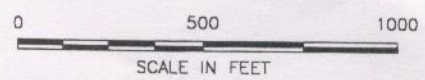

 UNDERGROUND ENGINEERING & ENVIRONMENTAL SOLUTIONS	FORMER EMERSON STREET LANDFILL SUB-SLAB VENTILATION SYSTEM GUIDANCE DOCUMENT CITY OF ROCHESTER ROCHESTER, NEW YORK
	FESL EMISSION QUADRANTS AND LANDFILL GAS MEASUREMENT LOCATIONS
SCALE: AS SHOWN	MAY 2000

FIGURE 1

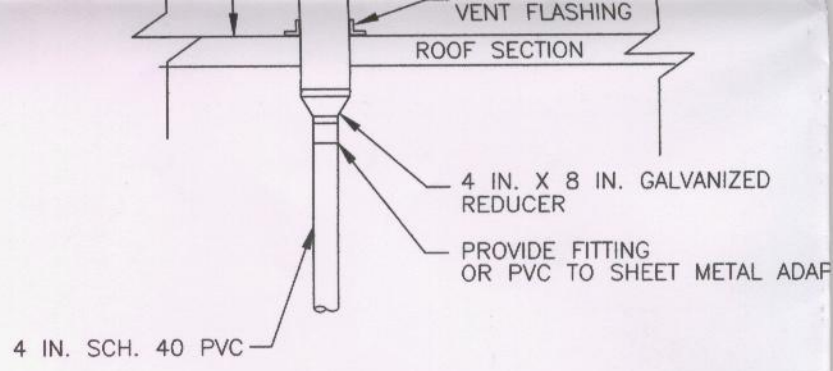
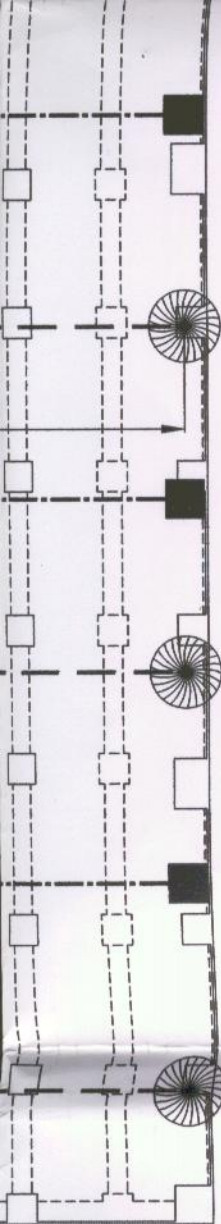

DETAIL 3 - TYPICAL EXHAUST TERMINATION (TYPE II SYSTEM)
NOT TO SCALE

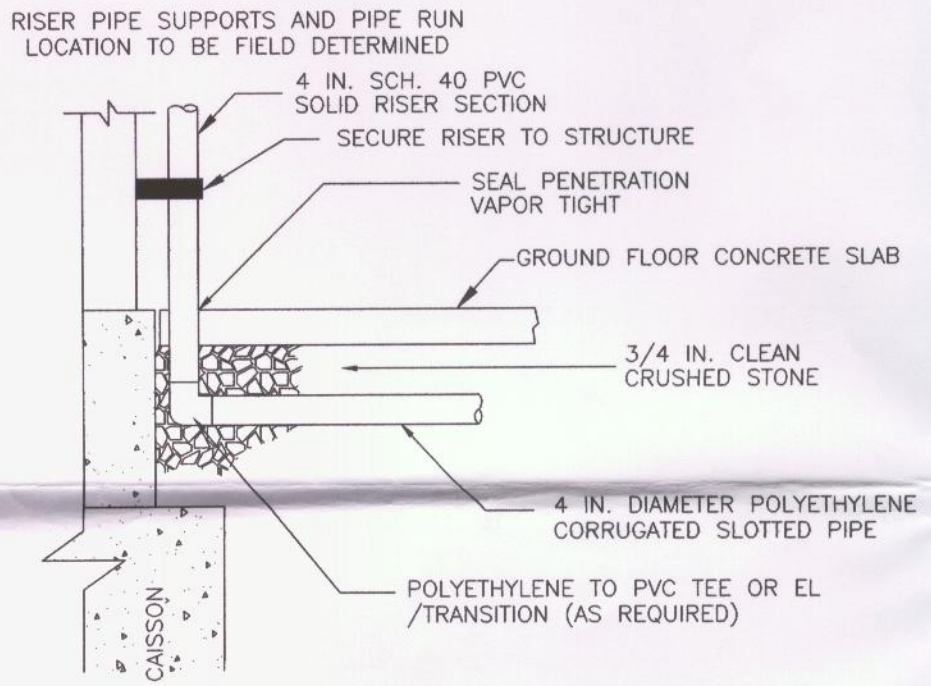

SECTION 3 - TYPICAL INTAKE/EXHAUST SECTION AT EXTERIOR FOOTING OR COLUMN (IF APPLICABLE)
NOT TO SCALE

ISSUE	DATE	REVISIONS	BY
B	5/12/00	REVISED PER CITY COMMENTS	H&A
A	2/3/98	ISSUE FOR CONSTRUCTION	H&A

**H
A**

**UN
EN
EN
SO**

Haley
189 N.
Roches
Tel: 71
Fax: 7

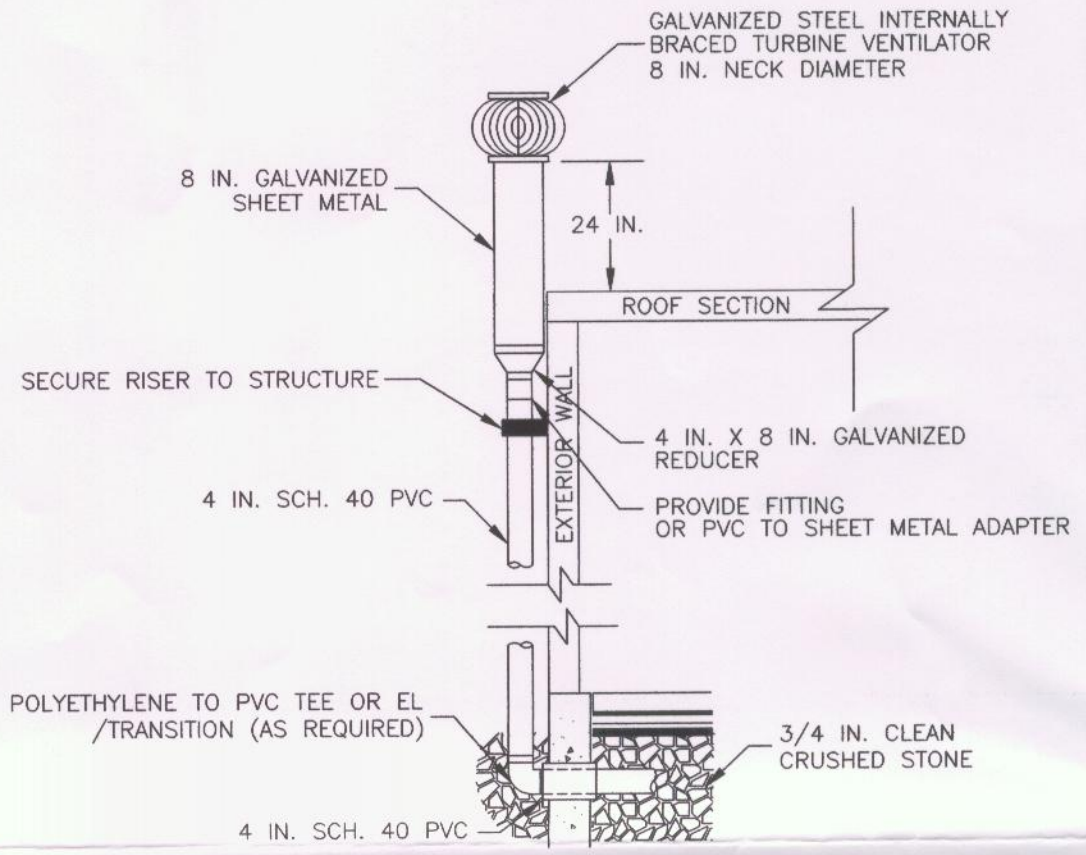
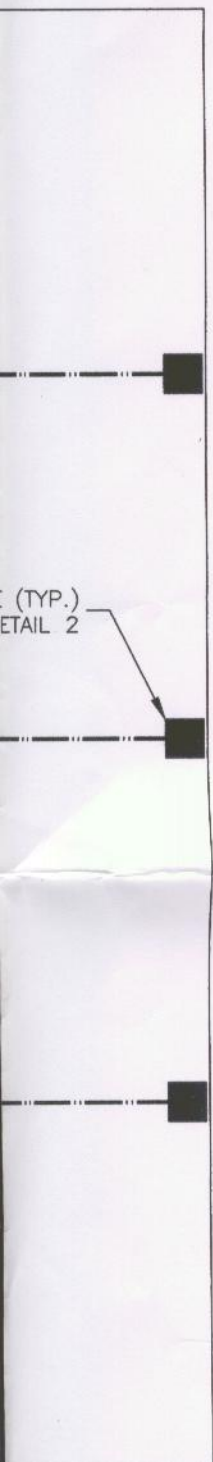

DETAIL 1 - TYPICAL EXHAUST TERMINATION (TYPE I SYSTEM)
NOT TO SCALE

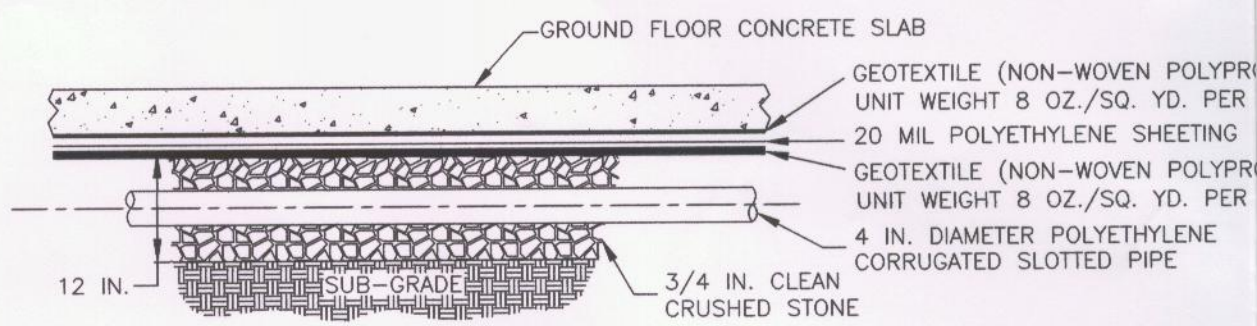

SECTION 1 - TYPICAL VAPOR BARRIER (TYPE I SYSTEM)
NOT TO SCALE

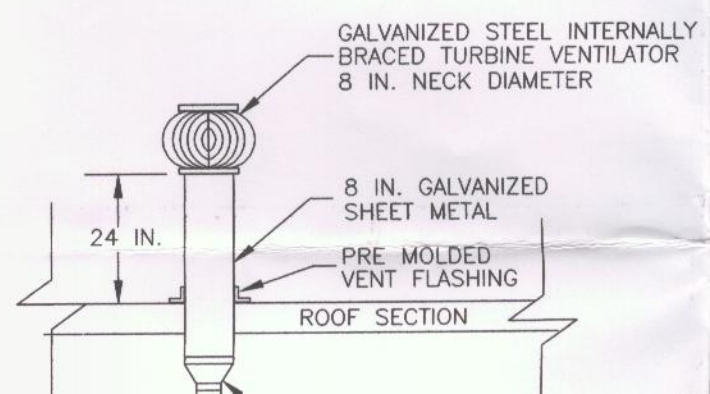
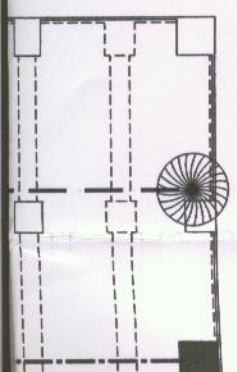

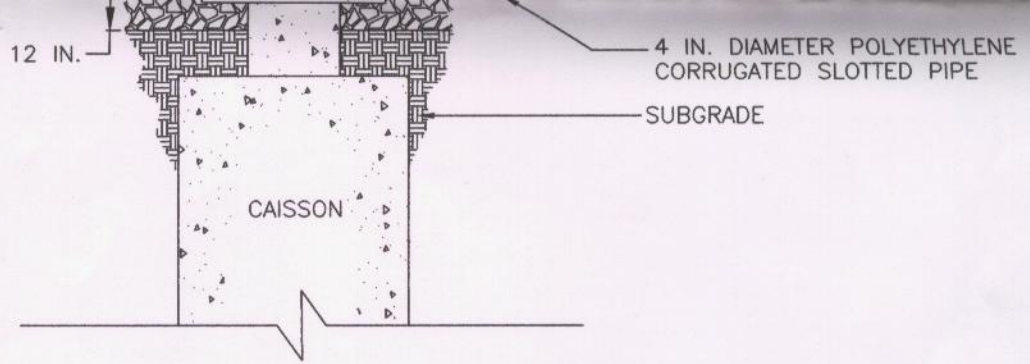

SECTION 2 - TYPICAL SECTION THROUGH GRADE BEAM (TYPE II SYSTEM)
NOT TO SCALE

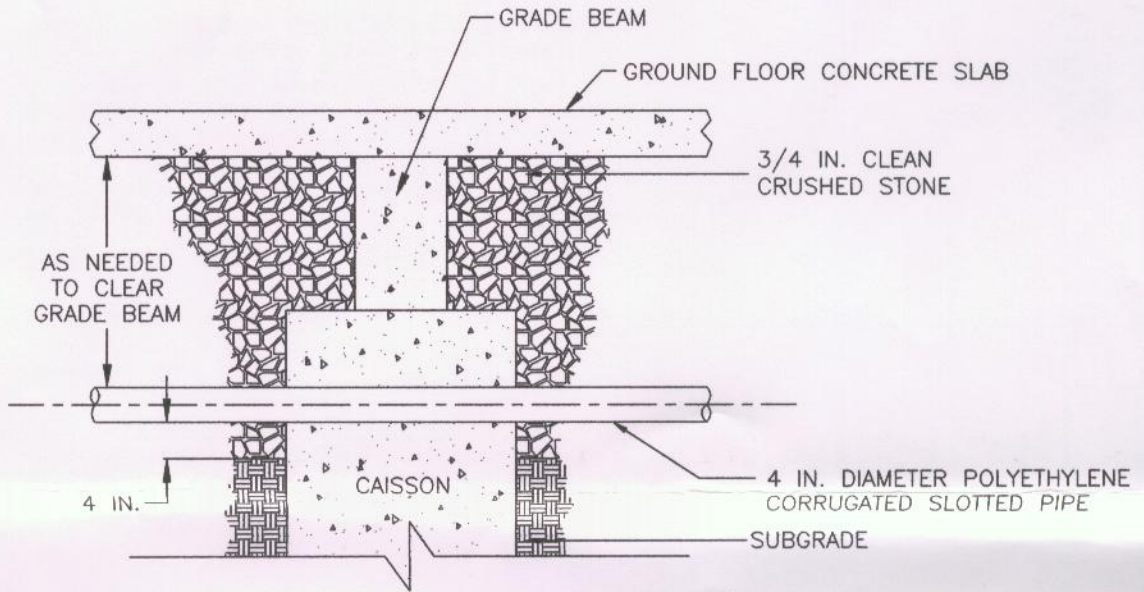

SECTION 2 - ALTERNATIVE TYPICAL SECTION UNDER GRADE BEAM (TYPE II SYSTEM)
NOT TO SCALE



UNDERGROUND
ENGINEERING &
ENVIRONMENTAL
SOLUTIONS

Malley & Aldrich, Inc.
100 North Water Street
Rochester, New York 14604-1151
Tel: 716.232.7386
Fax: 716.232.6768

CITY OF ROCHESTER
DIVISION OF ENVIRONMENTAL SERVICES
FESL GUIDANCE DOCUMENT
ROCHESTER, NEW YORK

EXAMPLE SUB-SLAB VENTILATION SYSTEM PLAN AND DETAILS

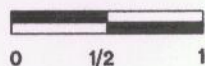

THIS BAR MEASURES
FOOT AT TRUE SCALE

Date:
JAN 1998

Scale:
AS SHOWN

File No.
70352-053

Filename:
VENTPLNB.DWG

Project Engineer:

SLB

Designed By:

SLB

Drawn By:

IRC/RJS

Checked By:

JES

Sheet No.:

1 of 1

Drawing No.

SV-1

Issue

A

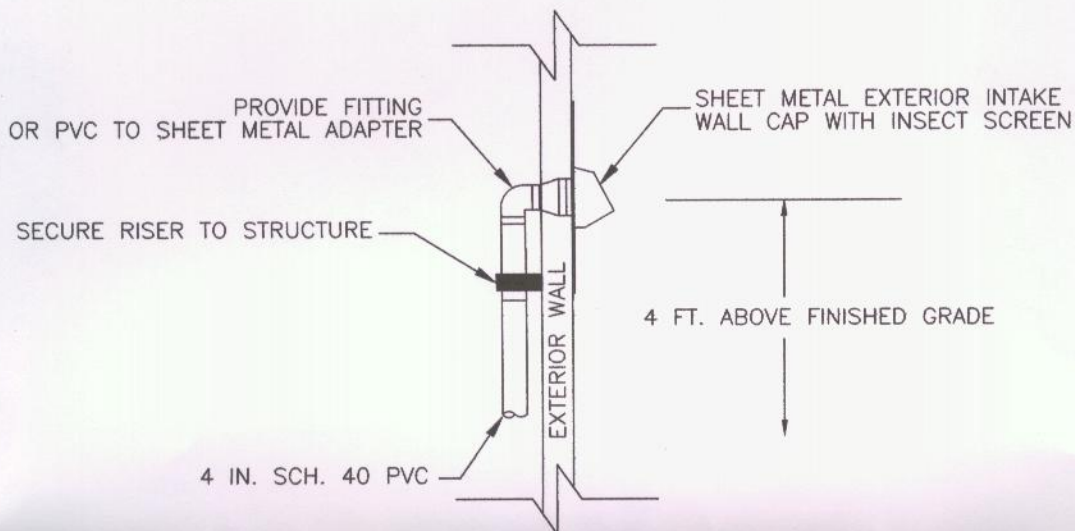

DETAIL 2 - TYPICAL INTAKE TERMINATION (TYPE I & II SYSTEM)

NOT TO SCALE

SECTION 1 NOTES:

1. SUBGRADE SHOULD BE PREPARED PRIOR TO PLACEMENT OF GEOTEXTILE AND/OR POLYETHYLENE SHEETING. PREPARATION SHOULD INCLUDE GRADING AND REMOVAL OF MATERIALS THAT COULD PUNCTURE THE POLYETHYLENE SHEETING.
2. DEPENDENT ON FIELD CONDITIONS AND BUILDING CONSTRUCTION, PLACEMENT OF THE GEOTEXTILE ABOVE AND/OR BELOW THE POLYETHYLENE SHEETING MAY NOT BE NECESSARY. THE GEOTEXTILE SHOULD BE PLACED WHEN FIELD CONDITIONS COULD NEGATIVELY IMPACT THE INTEGRITY OF THE SHEETING. THESE FIELD CONDITIONS INCLUDE, BUT ARE NOT LIMITED TO, THE PRESENCE OF ANGULAR SUBGRADE MATERIALS AND PLACEMENT OF REINFORCED CONCRETE ABOVE THE SHEETING.
3. CARE SHOULD BE TAKEN NOT TO PUNCTURE THE POLYETHYLENE SHEETING. HEAVY EQUIPMENT (INCLUDING TRUCKS) SHOULD NOT BE DRIVEN OVER THE PLACED SHEETING AND GEOTEXTILE.
4. SEAL ANY PENETRATIONS OF THE BARRIER MATERIAL FOR PIPING, ETC.
5. SEAL SEAMS IN BARRIER AS RECOMMENDED BY MANUFACTURER.

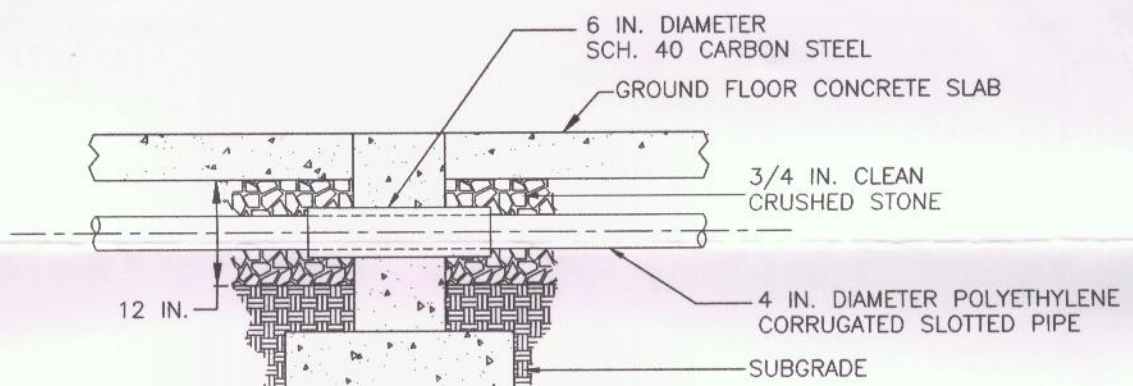

50 FT ± (TYP.)

INTAK
SEE [

TYPICAL SYSTEM WITH SLAB-ON-GRADE TYPE FOUNDATION (TYPE I)
NOT TO SCALE

20 FT. ± (TYP.)



TURBINE (TYP. TYPE I)
SEE DETAIL 1



TURBINE (TYP. TYPE II)
SEE DETAIL 4

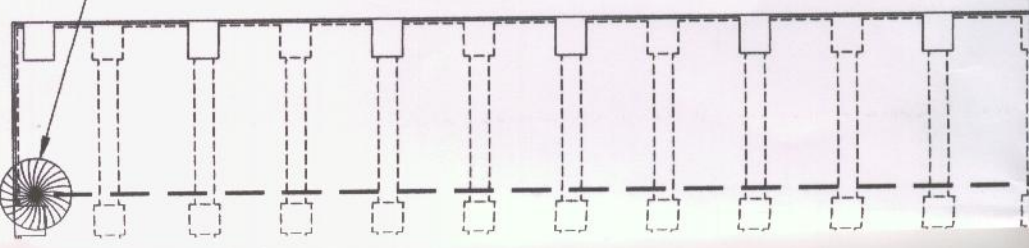

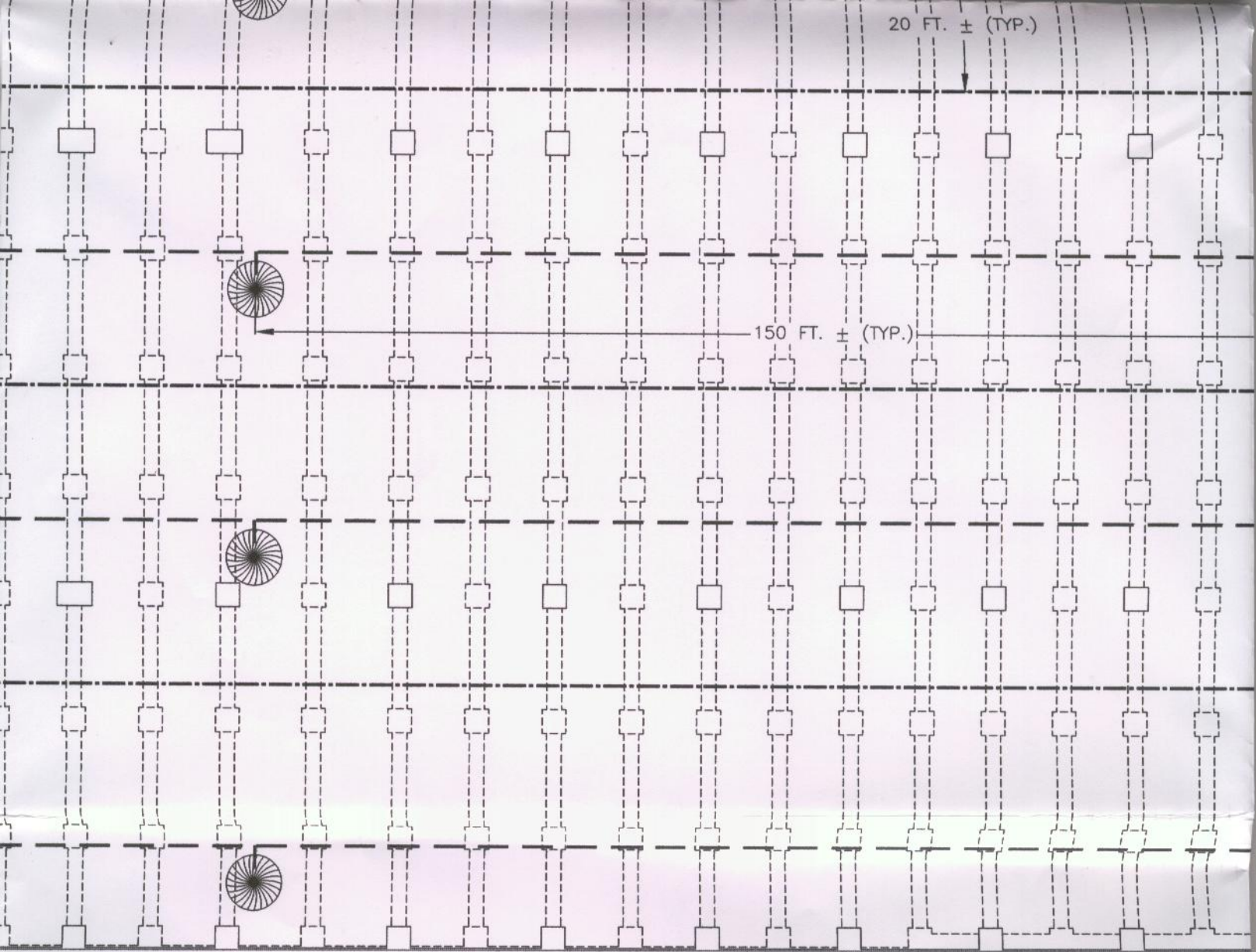

TYPICAL SYSTEM WITH CAISSON OR PIER TYPE FOUNDATIONS (TYPE II)
NOT TO SCALE

NOTES:

1. SECTION 2 - ALTERNATIVE SHALL NOT BE USED IF HIGH GROUNDWATER ELEVATION IS LESS THAN TWO FEET BELOW THE BOTTOM OF THE GRADE BEAM.
2. SYSTEM LAYOUTS ARE APPROXIMATE AND SHOULD BE USED AS A TYPICAL DESIGN FORMAT FOR BUILDINGS. DISTANCES BETWEEN PIPING AND RISERS ARE APPROXIMATE AND MAY NEED TO BE MOVED BASED ON ACTUAL BUILDING FOUNDATION CONSTRUCTION.

50 FT ± (TYP.)

INTAK
SEE [

TYPICAL SYSTEM WITH SLAB-ON-GRADE TYPE FOUNDATION (TYPE I)
NOT TO SCALE

20 FT. ± (TYP.)



INTAKE (TYP.)
SEE DETAIL 2

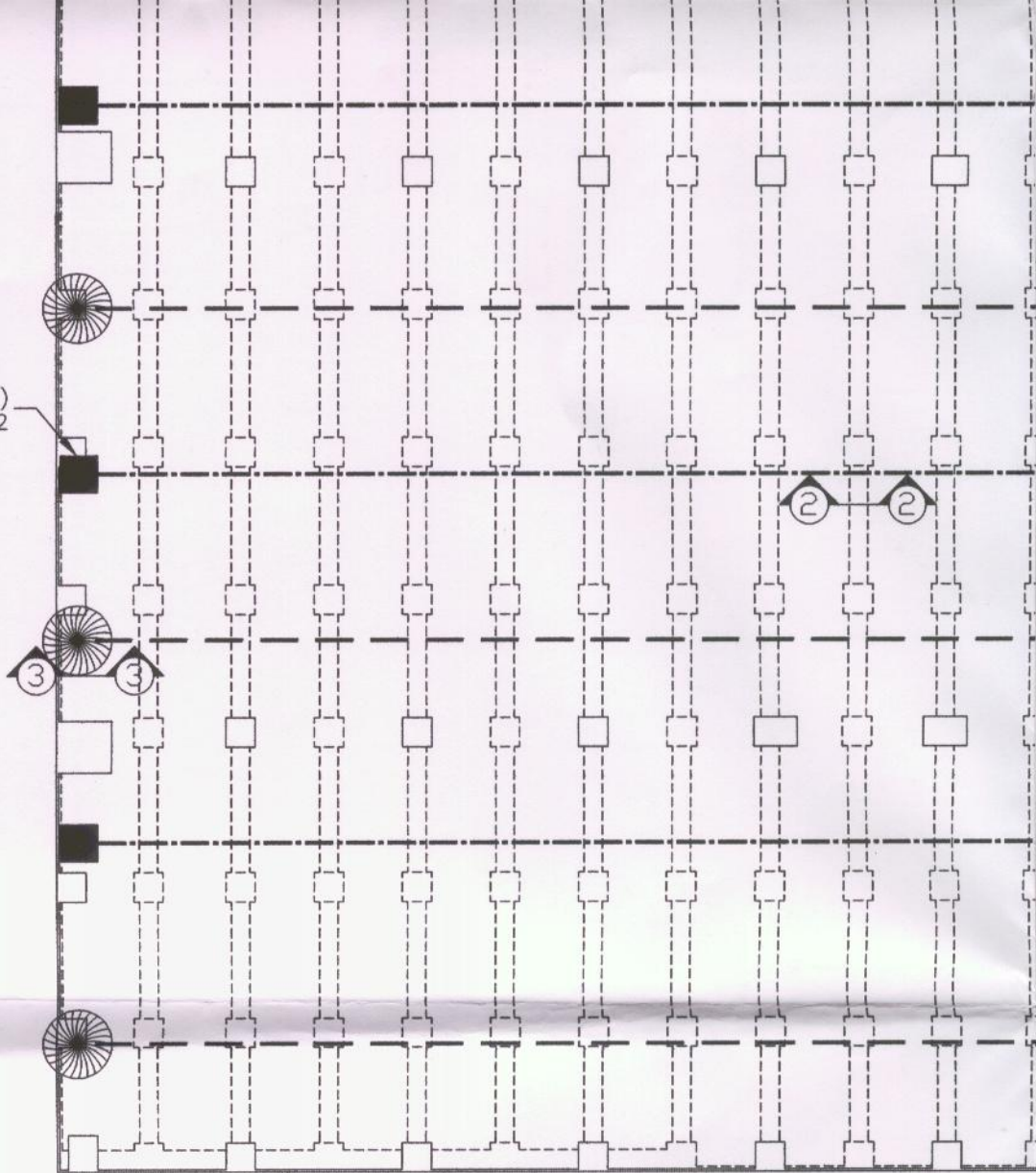

LEGEND





-  INTAKE RISER
-  TYPE I OR II EXHAUST RISER
-  PASS-THRU PIPING
-  INTAKE PIPING
-  EXHAUST PIPING

TABLE I
 CITY OF ROCHESTER, NEW YORK
 FORMER EMERSON STREET LANDFILL

SUMMARY OF METHANE EMISSION RATE CALCULATIONS
 (ug/m²-min)

SAMPLE LOCATION	MINIMUM	AVERAGE	MAXIMUM	STANDARD DEVIATION
LG-1	15	32	44	(14)
LG-2	8.4	40	97	(40)
LG-3	13	34	47	(15)
LG-4	210	630	1200	(430)
LG-5	51	110	140	(40)
LG-6	14	27	35	(9.1)
LG-7	7.9	24	35	(11)
LG-8	7.8	24	33	(11)
LG-9	8.2	64	190	(86)
LG-10	8.2	35	57	(20)
CONTROL	11	21	33	(11)

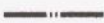
NOTES:

1. SHADED DATA APPEARS TO EXCEED CONTROL STATION.
2. CALCULATED EMISSION RATES EXPRESSED IN UNITS OF MICROGRAMS PER SQUARE METER PER MINUTE (ug/m²-min), AND EXTRAPOLATED FROM LANDFILL GAS COLLECTION DEVICE SAMPLING. ACTUAL EMISSION RATES WILL VARY.
3. SEE FIGURE 6 FOR LANDFILL GAS SAMPLING LOCATIONS.

VBD:\WKS123\70352-46\TABL6.WK1

Table 2

City of Rochester Sub-Slab Ventilation Guidance Document
 Example Gas Flux Calculation and Summary Table

Quadrant	Maximum Landfill Gas Measurements (ug/m ² -min)		Average Landfill Gas Measurement (ug/m ² -min)	Landfill Gas Flux (moles methane/min)	Landfill Gas Flux Volume per 1000 ft ² Building Footprint (ft ³ /min)
	LG1	LG3			
A	44	47	46	0.0003	4.33E-04
B	97	1200	479	0.0028	4.56E-03
C	140	35	34	0.0002	3.24E-04
D	33	190	124	0.0007	1.18E-03
	57				

Notes:

1. Landfill Gas Measurement values obtained from "Former Emerson Street Landfill, Modified Remedial Investigation", H&A of New York, January 1994.
2. Landfill Gas flux is shown per 1000 square foot of building footprint. Gas fluxes should be calculated for the actual building size.

Example:

$$\frac{46 \mu\text{g methane}}{\text{m}^2 \cdot \text{min}} \times 1000 \text{ ft}^2 \times \frac{1 \text{ m}^2}{(3.2808 \text{ ft.})^2} \times \frac{1 \text{ mg}}{1000 \mu\text{g}} \times \frac{1 \text{ mole}}{16 \text{ g}} \times \frac{1 \text{ g}}{1000 \text{ mg}} = \frac{0.0003 \text{ mole}}{\text{min}}$$

$$\text{Eqn: } V = n \frac{V_s}{N_s} \frac{T}{T_s} \frac{P_s}{P}$$

- Vs/Ns = 0.0224 m³/mole (STP)
- Ts = Temperature (K, STP)
- Ps = Pressure (atm, STP)
- V = Volume (m³, ambient conditions)
- T = Temperature (K, ambient conditions)
- P = Pressure (atm, ambient conditions)
- n = number of moles/min

$$V = \frac{0.0003 \text{ mole}}{\text{min}} \times \frac{0.0224 \text{ m}^3}{\text{mole}} \times \frac{328 \text{ K}}{273 \text{ K}} \times \frac{1.00 \text{ atm}}{1.00 \text{ atm}} \times \frac{1 \text{ ft}^3}{0.0283 \text{ m}^3} = 2.51 \times 10^{-4} \text{ ft}^3 / \text{min}$$

The landfill gas at the FESL is approximately 58% methane:

$$\frac{2.51 \times 10^{-4} \text{ ft}^3/\text{min}}{0.58} = 4.33 \times 10^{-4} \text{ ft}^3/\text{min total landfill gas}$$

LABELLA
LaBella Associates, P.C.

300 State Street
Rochester, New York 14614

Appendix 8

Former Emerson Street Landfill Sub-Slab Ventilation Guidance Document Update 2007

Prepared for:

City of Rochester Division of Environmental Quality
30 Church Street
Room 300B
Rochester, New York 14614

LaBella Project No. 207392

November 2007

Former Emerson Street Landfill Sub-Slab Ventilation Guidance Document Update 2007

Prepared for:

City of Rochester Division of Environmental Quality
30 Church Street
Room 300B
Rochester, New York 14614

LaBella Project No. 207392

November 2007

LaBella Associates, P.C.
300 State Street
Rochester, New York 14614

TABLE OF CONTENTS

1.0	INTRODUCTION AND BACKGROUND	1
2.0	EXISTING SITE SOIL-GAS CONTAMINATION INFORMATION	3
3.0	RECOMMENDED ADDITIONAL SAMPLING.....	4
3.1	Sampling Methods & Procedures	4
3.2	Interpreting Sampling Results	5
4.0	DESCRIPTION OF VENTILATION SYSTEMS	5
5.0	RECOMMENDATIONS FOR INSTALLATION AND MAINTENANCE.....	8
6.0	CONTACT INFORMATION.....	10

Figures:

Figure 1	Landfill Deposition Years
Figure 2	High Methane Evolution Areas
Figure 3	Chlorinated VOC Contamination Areas
Figure 4	Chlorinated-VOC and Methane Problem Areas
Figure 5	Building Sub-Slab Ventilation System Plan and Details
Figure 6	Parking Lot/Paved Area Ventilation Plan and Details

Appendices:

Appendix 1	Example Specifications for Sub-Slab Ventilation System
Appendix 2	Select pages from "Guidance for Evaluating Soil Vapor Intrusion in the State of New York", New York State Department of Health, 2006.
Appendix 3	Select pages from "DER-13/Strategy for Evaluating Soil Vapor Intrusion at Remedial Sites in New York", New York State Department of Environmental Conservation, 2006.
Appendix 4	Select pages from "OSWER Draft Guidance for Evaluating the Vapor Intrusion to Indoor Air Pathway from Groundwater and Soils (Subsurface Vapor Intrusion Guidance)", United States Environmental Protection Agency (USEPA), November 2002
Appendix 5	Soil Gas Figures from "Former Emerson Street Landfill Remedial Investigation Report for Parcels 4, 10, and 11", LaBella Associates P.C., and Geomatrix Consultants, Inc., March 2001

**FORMER EMERSON STREET LANDFILL
SUB-SLAB VENTILATION GUIDANCE DOCUMENT
UPDATE 2007**

1.0 INTRODUCTION AND BACKGROUND

In recent years, vapor intrusion has come to the attention of government agencies concerned with public health. Sub-slab vapor intrusion occurs when volatile hazardous chemicals accumulate beneath the building slab and migrate into the building due to a pressure difference between the building and the sub-slab. This pressure difference is most commonly present during the heating season. For landfill sites where landfill gas, which typically includes methane gas, is being actively produced through decomposition of waste, vapor intrusion is more likely throughout the year. The constituents of landfill gas, causes the threat of accumulation of explosive levels of methane, in addition to the health risks of long term exposure to lower levels. Other volatile organic chemicals, which can be found in landfills and other industrial and commercial sites, have the potential to migrate into buildings, chlorinated volatile organic compounds (Chlorinated-VOCs) are of particular concern due to the toxicity associated with chlorine functional groups in organic molecules.

This guidance document was developed by LaBella Associates, P.C. (LaBella), on behalf of the City of Rochester's Division of Environmental Quality (DEQ), as an update of the document titled "Former Emerson Street Landfill Sub-Slab Ventilation Guidance Document" dated May 2000 by Haley and Aldrich of New York for the City of Rochester (hereafter referred to as "The 2000 Guidance Document"). Background and historical information that is quoted from the 2000 Guidance Document appears in italics. The 2000 Guidance Document and this 2007 Updated Guidance Document were developed *to assist the City of Rochester with design guidance of sub-slab ventilation (or landfill gas abatement) systems in buildings constructed over solid waste and/or ash contained within the former Emerson Street Landfill (FESL). This document was produced in response to the Monroe County Department of Health (MCDOH) concerns regarding the possibility of landfill gases seeping into the sub-slab portions of such buildings.* This updated document also addresses the need to provide guidance for paved surfaces within the landfill footprint.

It should be noted that the City of Rochester has applied an Environmental Institutional Control (EIC) to parcels located within the FESL. The EIC system requires DEQ approval as part of the City Permit process for any construction activity on a parcel flagged by the system. The City of Rochester coordinates with the New York State Department of Environmental Conservation (NYSDEC), New York State Department of Health (NYSDOH) and/or Monroe County Department of Health (MCDOH) as needed.

The existing 2000 Guidance Document has become outdated due to the promulgation of new guidelines by the NYSDOH and the NYSDEC in October 2006. The NYSDOH document is titled "Guidance for Evaluating Soil Vapor Intrusion in the State of New York", and the NYSDEC companion document is titled "DER-13 / Strategy for Evaluating Soil Vapor Intrusion at Remedial Sites in New York". The NYSDEC document describes the State's criteria for evaluating new and existing sites in order to determine whether these sites have the potential for exposures related to soil vapor intrusion. The FESL

FORMER EMERSON STREET LANDFILL
SUB-SLAB VENTILATION GUIDANCE DOCUMENT
UPDATE 2007

appears on the "List of Inactive Hazardous Waste Sites with Pre-2003 Remedial Decisions where Disposal of Chlorinated Hydrocarbons Occurred", however, the priority rankings of these sites have not yet been published. The new NYSDOH guidance includes recommendations for active depressurization systems, (as opposed to the passive systems described in the 2000 Guidance Document), as well as recommendations for testing and reporting. This updated document takes into account these recommendations.

Previous FESL investigations have correlated historical information regarding the variable composition of the landfill and analytical data at specific locations. Historic aerial photographs have been reviewed to determine the date of filling of different portions of the landfill. This information was useful because it is known that during the final years of the landfill's operational life (the early 1970s); the site incinerator was no longer functioning properly, resulting in inadequately incinerated waste, and a high percentage of un-incinerated, putrescible waste. Putrescible waste poses multiple difficulties for future redevelopment. First, its decomposition results in differential settling, requiring more comprehensive building structures. Second, the decomposition of the waste produces methane and other landfill gasses, which pose the threat of accumulation in buildings resulting in potential explosion or chronic toxicity. In addition, analytical data indicating the presence of Chlorinated-VOCs suggests the likelihood that non-permitted disposal of industrial chemicals and/or miscellaneous disposal of household waste containing chemicals may have taken place at the FESL. The portions of the landfill where possible non-permitted disposal took place are listed as a NYSDEC Inactive Hazardous Waste Disposal Site (IHWDS). Landfill disposal by year and the limits of the IHWDS are shown on Figure 1.

Available analytical data types relevant to soil vapor migration include the following:

- ground surface landfill gas flux measurements throughout the landfill;
- soil gas measurements for methane, vinyl chloride (a Chlorinated-VOC), and the VOCs: benzene, toluene, ethylbenzene, and xylenes (BTEX) across a limited area (the state-listed IHWDS portion of the landfill, see Figure 1);
- PID measurements taken in utility vaults and sewers along roadways surrounding the landfill;
- soil samples for select Chlorinated-VOCs from borings across the landfill; and
- groundwater samples for select Chlorinated-VOCs from wells installed across the landfill.

In this document, a methodology for selecting an appropriate ventilation system is described that is dependent on landfill gas and Chlorinated-VOC measurements in the geographic location of the proposed buildings or parking lot (with respect to the footprint of the FESL), and the type of foundation required for a building. In general, a more robust ventilation system is recommended in areas of either higher historical contamination measurements, or where high putrescible-waste content requires caisson foundation styles. Parking lot venting systems are recommended in areas with high historical methane measurements.

2.0 EXISTING SITE SOIL-GAS CONTAMINATION INFORMATION

The report "Former Emerson Street Landfill, Modified Remedial Investigation", H&A of New York, January 1994, contains applicable landfill gas flux information. During this investigation, landfill gas measurements were obtained across the landfill area with specially-designed gas flux chambers. As summarized in the report, landfill gas is typically composed of 58% methane, 42% carbon dioxide, and trace amounts of hydrogen sulfide and other organic compounds. Methane emission rates varied in the FESL samples from a minimum of 7.8 to a maximum of 1200 $\mu\text{g}/\text{m}^2\text{-minute}$. Results are summarized on Figure 2. The H&A report also contains analytical information for Chlorinated-VOCs in soil, groundwater, and utility vault water samples, and PID readings for utility vaults and manholes. Analytical results indicated the presence of Chlorinated-VOCs at various locations throughout the landfill, but concentrated in the IHWDS portion. Results are summarized on Figure 3.

The report "Former Emerson Street Landfill Remedial Investigation Report for Parcels 4, 10, and 11", LaBella Associates P.C., and Geomatrix Consultants, Inc., March 2001, describes sampling completed in the IHWDS portion of the landfill. Sampling was completed in soil, groundwater, sewers, and extensive soil gas points. For the purpose of this guidance document, sewer samples were not reviewed as they did not add additional areas to problem areas identified by the sampling in other media. Analytical results confirmed and further delineated the presence of Chlorinated-VOCs in the IHWDS portion of the landfill. The soil gas results for the specific constituents detected in this summary are briefly summarized below:

- Vinyl chloride concentrations ranged from 0.02 milligrams per cubic meter (mg/m^3) to 9 mg/m^3 ;
- Benzene concentrations ranged from 0.02 mg/m^3 to 0.6 mg/m^3 ;
- Total BTEX concentrations ranged from 0.48 mg/m^3 to 499 mg/m^3 ;
- Chlorobenzene concentrations ranged from 0.02 mg/m^3 to 1.6 mg/m^3 ; and,
- Methane concentrations ranged from 380 ppm to 790,000 ppm.

The cumulative results are summarized on Figure 3.

The FESL can be separated into four general geographic regions (FESL Quadrants) based on the landfill waste composition and historic analytical data. The composition of the landfill will likely impact the type of building design that will be developed. In other words, buildings constructed over areas of high non-ash, potential putrescible solid waste will more likely have pier or caisson-style foundations to provide structural stability, and this type of foundation does not allow easy implementation of a plastic sheeting type liner as a vapor barrier. For caisson or pier type foundations, cold-spray applied membrane liners are recommended. Conversely, a standard concrete footing with slab on grade foundation type is more amenable to implementation of a system utilizing a plastic sheeting type vapor barrier.

The characteristics of the FESL Areas are summarized on Figure 4 and below:

FORMER EMERSON STREET LANDFILL
SUB-SLAB VENTILATION GUIDANCE DOCUMENT
UPDATE 2007

Quadrants A and B (North of Emerson Street):

Portions of Quadrants A and B were filled during the 1970's, the last years of the landfill's operational life (Figure 1). At this time the incinerator was no longer operating properly, resulting in unincinerated putrescible waste being deposited in the landfill during that period. These portions of the landfill are characterized by thicker fill, higher percentage of potentially putrescible solid waste and less incinerated ash, and higher landfill gas flux at the surface relative to other FESL areas sampled. These areas are characterized by landfill gas flux measurements between 100 and 1200 $\mu\text{g}/\text{m}^2\text{-minute}$, and/or soil gas methane concentrations above 5,000 ppm. In addition, these quadrants have also been characterized with Chlorinated-VOC contamination in soil gas, soil, and groundwater. Quadrant A is distinguishable from Quadrant B by a larger area of documented Chlorinated-VOC contamination present in Quadrant A. The listed IHWDS portions of the landfill are located within Quadrant A.

Quadrant C (South of Emerson Street, East of Colfax Street):

Quadrant C is characterized by thinner fill, lower percentage of potentially putrescible solid waste and more incinerated ash, and intermediate landfill gas flux at the surface relative to other FESL areas sampled. This area is characterized by landfill gas flux measurements between 50 and 200 $\mu\text{g}/\text{m}^2\text{-minute}$. It has been hypothesized that this may be related to the presence of organic rich marsh-derived soils at depth in this area, as opposed to landfill related gas. There is also an area of Chlorinated-VOC contamination in this quadrant.

Quadrant D (South of Emerson Street, West of Colfax Street):

Quadrant D is characterized by thinner fill, lower percentage of potentially putrescible solid waste and ash that was more efficiently and completely incinerated, and lower landfill gas flux at surface relative to other FESL areas sampled. This area is characterized by landfill gas flux measurements below 50 $\mu\text{g}/\text{m}^2\text{-minute}$. In addition, there are several small areas of Chlorinated-VOC contamination in this quadrant, which may be the result of post-landfill industrial activity as opposed to landfill operations.

3.0 RECOMMENDED ADDITIONAL SAMPLING

This section describes the recommended additional sampling prior to redevelopment of FESL parcels.

3.1 Sampling Methods & Procedures

Site specific soil gas sampling is recommended, though not required, prior to redevelopment. Predevelopment sampling would be particularly useful in Quadrants C and D where less comprehensive data is available. Recent information would be of great value in customization of the design of sub-slab depressurization systems and parking lot vent systems. In the case of parking lots, quantitative sampling could demonstrate that there is no need for a vent system.

FORMER EMERSON STREET LANDFILL
SUB-SLAB VENTILATION GUIDANCE DOCUMENT
UPDATE 2007

If sampling is performed, it is recommended that data be collected from soil gas points advanced approximately 4-feet below ground surface, or at a depth that corresponds to the depth of the building slab. Soil gas samples can be analyzed either qualitatively or quantitatively. Qualitative analysis can be done using a PID for total VOCs and a portable gas analyzer for methane. Quantitative analysis can be done with a portable gas chromatograph, or sample collection and laboratory analysis for methane, Chlorinated-VOCs, and petroleum related VOCs. Recent NYSDOH guidance indicates sampling using low flow rates (less than 0.2 liters per minute) using Summa Canisters that are pre-cleaned by the laboratory. The typical analytical method for VOCs is the United States Environmental Protection Agency (USEPA) Method TO-15. Detailed guidance on soil gas sampling is provided in the NYSDOH "Guidance for Evaluating Vapor Intrusion in the State of New York", portions of which are reproduced as Appendix 2 of this document.

3.2 Interpreting Sampling Results

A useful resource for understanding the significance of measured concentrations of different soil gas contaminants is the USEPA document entitled "OSWER Draft Guidance for Evaluating the Vapor Intrusion to Indoor Air Pathway from Groundwater and Soils (Subsurface Vapor Intrusion Guidance)", November 2002. Lookup tables are included in the USEPA guidance, and attached in Appendix 4, that provide target concentrations for a wide range of chemicals that pose vapor migration concerns. This guidance was used to develop the Chlorinated-VOC contamination areas shown in Figure 3. [Note: NYSDOH may be developing additional lookup tables or matrices, as such; NYSDOH should also be consulted once sample results are available.]

4.0 DESCRIPTION OF VENTILATION SYSTEMS

Buildings:

Due to the potential presence of methane and/or Chlorinated-VOCs, engineering controls are recommended at all new buildings constructed within the footprint of the landfilling at the FESL, as indicated on Figure 1. Areas that are within the site boundary but outside landfill areas may be demonstrated to not require ventilation systems based on sampling and analysis. It should be noted that for VOCs, soil gas testing in the absence of a slab and the associated pressure differential may not be a good predictor of the absence of a soil vapor migration problem. Following building construction, additional testing would be required, per the NYSDOH guidance, and if vapor migration were found to be occurring, a 'retrofit' system would need to be designed and built. It is more cost effective, easier and more effective to build a system prior to building construction than afterwards. With that in mind, the basic system recommended for buildings is an active sub-slab depressurization system. For all Quadrants, it is recommended that the system consists of the following components:

- an impermeable vapor barrier that inhibits migration of landfill gases through the sub-slab and into the building (see below for specifics);
- sub-slab vent pipes that provide a conduit for landfill gas to the exterior of the building;

FORMER EMERSON STREET LANDFILL
SUB-SLAB VENTILATION GUIDANCE DOCUMENT
UPDATE 2007

- fans attached to the vent pipes that result in active depressurization of the sub-slab;
- an alarm system demonstrating that the system is operating, which should be located conspicuously in an area frequented by a person responsible for monitoring the system's status (an informational sheet with emergency contact information and that briefly describes the operation of the system should be available in the alarm area);
- crushed stone placed in vent-pipe trenches and a layer of crushed stone or sand (depending on the structural needs of the slab) beneath the entire slab to act as a high permeability zone for gas migration and pressure field extension; and
- permanent gauge points to evaluate the effectiveness of the system.

Based on the geographic location described above, LaBella recommends the impermeable vapor barrier liner for the system be one of the two following types:

- Type I: 15 mil reinforced polyethylene sheeting; or,
- Type II: 60 mil spray-applied membrane

The Type I liner is appropriate for buildings constructed south of Emerson Street (Quadrants C and D) if the foundation is a standard concrete footing with slab on grade type. The Type II liner is appropriate for buildings constructed north of Emerson Street (Quadrants A and B), regardless of foundation type, and for buildings constructed south of Emerson Street (Quadrants C and D) with caisson or pile type foundations.

Example building layouts and construction details are provided in Figures 5 and 6. Example specifications are provided in Attachment 1.

A conceptual decision matrix for determining the recommended sub-slab ventilation system type is presented below:

FORMER EMERSON STREET LANDFILL
SUB-SLAB VENTILATION GUIDANCE DOCUMENT
UPDATE 2007

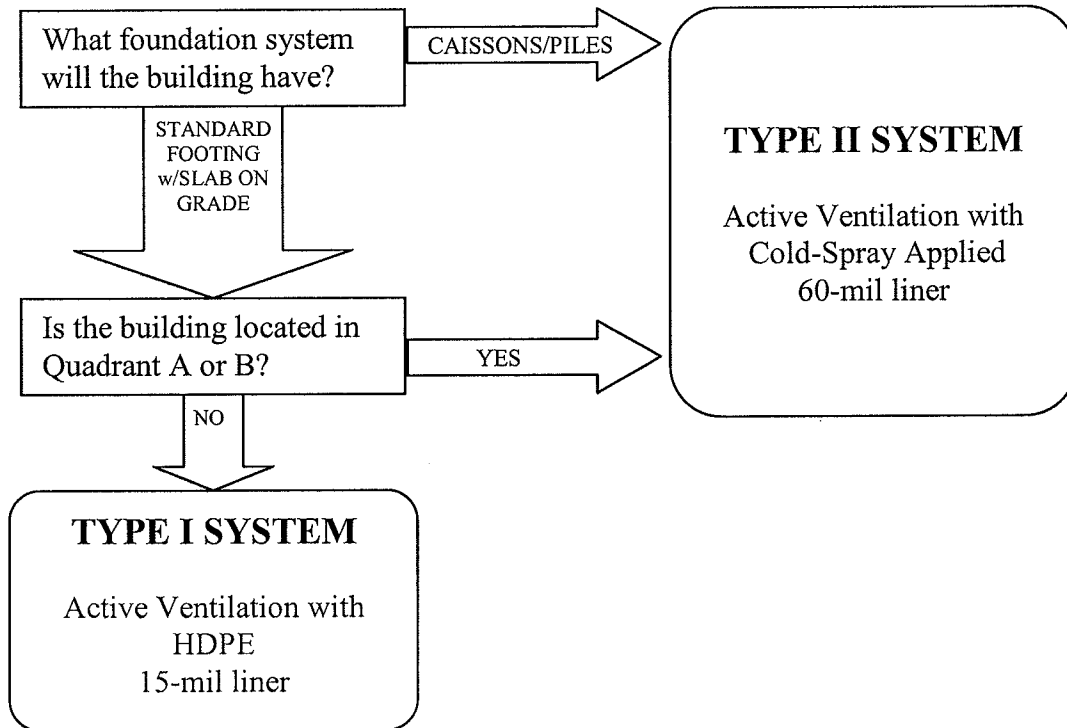

Parking Lots/Paved Areas:

When landfills that contain actively decomposing materials are capped, there are concerns that methane gas may accumulate to levels that could cause the threat of explosion. It is therefore recommended that when parking lots or other paved areas are planned within the FESL footprint, a vent system be designed to prevent methane accumulation. Areas not identified as methane areas on Figure 2 may not require vent systems if soil gas test results do not show methane gas evolution above $40 \mu\text{g}/\text{m}^2\text{-minute}$, or 100 ppm soil gas methane. While no definitive standards exist for methane gas levels, the $40 \mu\text{g}/\text{m}^2\text{-minute}$ value is based on being elevated with respect to a background sample of approximately $30 \mu\text{g}/\text{m}^2\text{-minute}$; and the 100 ppm value is based on elevation above natural background levels of 0 to 50 ppm. The evacuation action level is 5,000 ppm, or 10 % of the lower explosive limit (LEL) for methane, as determined by the U.S. National Fire Code.

As a rule of thumb, vents should be placed every 200 feet. Venting systems can be constructed either as well points (simpler and less expensive), or with horizontal piping lengths similar to the building sub-slab depressurization systems. Well points or horizontal piping should be screened/placed in the upper five feet of fill. All vents should be equipped with a stack that extends at least as high as the rooftops of nearby buildings, or 35 feet, whichever is greater. Stacks can be affixed to lighting systems as structural support when feasible. The stack may terminate in a water intrusion prevention device, a wind-driven

FORMER EMERSON STREET LANDFILL
SUB-SLAB VENTILATION GUIDANCE DOCUMENT
UPDATE 2007

exhaust turbine, or a flare, depending on the methane concentrations. Flares are only appropriate when a horizontal system is used, or the area to be paved is small enough (4000 sq ft) to be served by a single vent. Systems utilizing flares may be subsidized by the State when built in cooperation with the City. Flares are beneficial to the environment because they combust the methane to carbon dioxide (a less active greenhouse gas than methane) and water vapor. They are also helpful in preventing odor problems.

Example layouts and construction details are provided in Figures 5 and 6.

Air Emission Permitting/Registration Status:

According to the provisions of Title III 201-3.3.c of the New York State Air Pollution Regulations, emissions of methane, and trace constituents that are less than 1 percent by weight for any regulated air pollutant, or 0.1 percent by weight for any carcinogen, are classified as 'trivial' and are exempt from registration and permitting provisions of subparts 201-4 and 201-5. Benzene and vinyl chloride are the only carcinogens known to be present in soil vapor at the FESL. The highest known concentrations of benzene and vinyl chloride in soil gas at the site (measured by Geomatrix in 2001) are 0.000048 and 0.00072 percent, respectively. Concentrations of Chlorinated-VOCs in other media do not approach the 1 percent level, nor the 0.1 percent level, making it unlikely that higher concentrations would exist in the air in the vicinity of the contaminate media. Nonetheless, site specific soil gas data should be collected to confirm the registration exemption status prior to construction of a system.

5.0 RECOMMENDATIONS FOR INSTALLATION AND MAINTENANCE

The following recommendations are for general guidance purposes only, and are not to be used as construction specifications. Construction specifications should be developed by a qualified professional on a site-specific basis. Similarly, specific requirements for system maintenance and reporting should be coordinated with the appropriate regulatory agency or agencies (e.g. NYSDEC, MCDOH, NYSDOH, etc.)

General Building Sub-Slab Depressurization System Installation Recommendations:

- Design the layout of the piping so that the spacing between each piping length is approximately 15 feet.
- Limit the initial length of pipe running on one fan to 150 to 200 ft. Following initial radius of influence testing, pipe runs can be consolidated to run on as few fans as testing demonstrates can achieve adequate pressure fields. Radius of influence testing can only be done once the slab/asphalt surface course is in place.
- Include piping routed to separate fans around the perimeter of the building, as this is a common 'short-circuit' area. This will protect the rest of the system from pressure 'short-circuiting'.
- It is recommended that the installation of the system be overseen and/or inspected by a qualified professional. Regulatory agencies (e.g. NYSDEC, MCDOH, NYSDOH, etc.) may require submission of a report that documents the installation of the system.

FORMER EMERSON STREET LANDFILL
SUB-SLAB VENTILATION GUIDANCE DOCUMENT
UPDATE 2007

- Explosivity testing should be conducted on the vented air in each leg of the system before and during initial operation. It is recommended that the explosivity testing be performed prior to the purchase of exhaust fans. If the explosivity testing indicates significant levels of landfill gases (>5,000 ppm methane or 10% LEL), intrinsically safe fans are required.
- The degree to which the system can be refined for maximum efficiency (smallest number of fans) depends on the number of test points installed, since fans can only be eliminated when it is demonstrated that sufficient coverage is provided by fewer fans.
- *Avoid sharp items (e.g. larger stones, rebar) that could damage the integrity of the vapor barrier or piping, as appropriate.*

General Building Sub-Slab Depressurization System:

- Upon system completion, perform a positive-pressure smoke test of the vapor barrier and the system to detect any leaks around concrete cracks, floor joints, and at the suction point. Any leaks identified should be resealed until the smoke test passes (i.e., no smoke observed).
- Test buildings with natural draft combustion appliances for backdrafting and correct as necessary.
- Conduct a Pressure Field Extension test using the installed test points per the 2006 NYSDOH Guidance Document. The test can be performed by attaching a magnahelic micro pressure gauge to the gauge end, or by observing smoke being drawn in to the gauge end. This test must demonstrate that a vacuum is being created beneath the entire slab. [*Note: This test is included in the 2006 NYSDOH Guidance. See Appendix 2.*]
- When possible, route gauge points for pressure test points outside the building through the foundation rather than through the building floor, as slab penetrations provide potential contamination paths for future chemical spills.
- Air sampling is indicated if there is any indication of possible impediments to comprehensive sub-slab communication of the depressurization system (i.e., locations with wet or dense sub-slab soils, multiple foundations and footings, minimal pressure differentials between the interior and sub-slab). In buildings with basements, post-mitigation indoor air sampling from the basement alone (i.e., without a concurrent indoor air sample from the first floor) is recommended in most circumstances. See the NYSDOH Guidance Document, Section 3, for sampling protocols.
- Typically, post-mitigation sampling should be conducted no sooner than 30 days after installing a depressurization system. If the system is installed outside of the heating season or at the end of a season, post-mitigation air sampling may be postponed until the heating season, per the DOH.

System maintenance recommendations:

- Inspect external portions of the systems, including fans, piping, alarms, labeling, etc., biannually to evaluate system integrity. Repair or replace components as necessary.

FORMER EMERSON STREET LANDFILL
SUB-SLAB VENTILATION GUIDANCE DOCUMENT
UPDATE 2007

- Inspect fans monthly to ensure they are operating properly and are securely mounted. Repair or replace components as necessary.
- Inspect exhaust points monthly to ensure they haven't become plugged or blocked. Inspect more frequently in cold weather to ensure the exhaust points are not clogged by snow or ice.
- It is recommended that system inspections and maintenance be performed on a regular basis and that documentation of these activities be generated and retained. Regulatory agencies (e.g. NYSDEC, MCDOH, NYSDOH, etc.) may require that copies of such documentation be submitted.
- *Perform other maintenance activities as specified by manufacturer of installed equipment.*

6.0 CONTACT INFORMATION

The individuals, agencies, and organizations listed below may be contacted for additional information:

Joseph Biondolillo
City of Rochester, Department of Environmental
Services
Division of Environmental Quality
30 Church Street, Room 300B
Rochester, NY 14614
(585) 428-6649

Avon, NY 14414
(585) 226-2466

Mark Gregor
City of Rochester, Department of Environmental
Services
Division of Environmental Quality
30 Church Street, Room 300B
Rochester, NY 14614
(585) 428-5978

Todd Caffoe
NYSDEC Region 8
Div. of Hazardous Waste Remediation
6274 E. Avon Lima Road

Y:\ROCHESTER, CITY\207392\CLERICAL\WORD\RPT\R7F27RN1.DOC

LABELLA
LaBella Associates, P.C.

300 State Street
Rochester, New York 14614

Figures

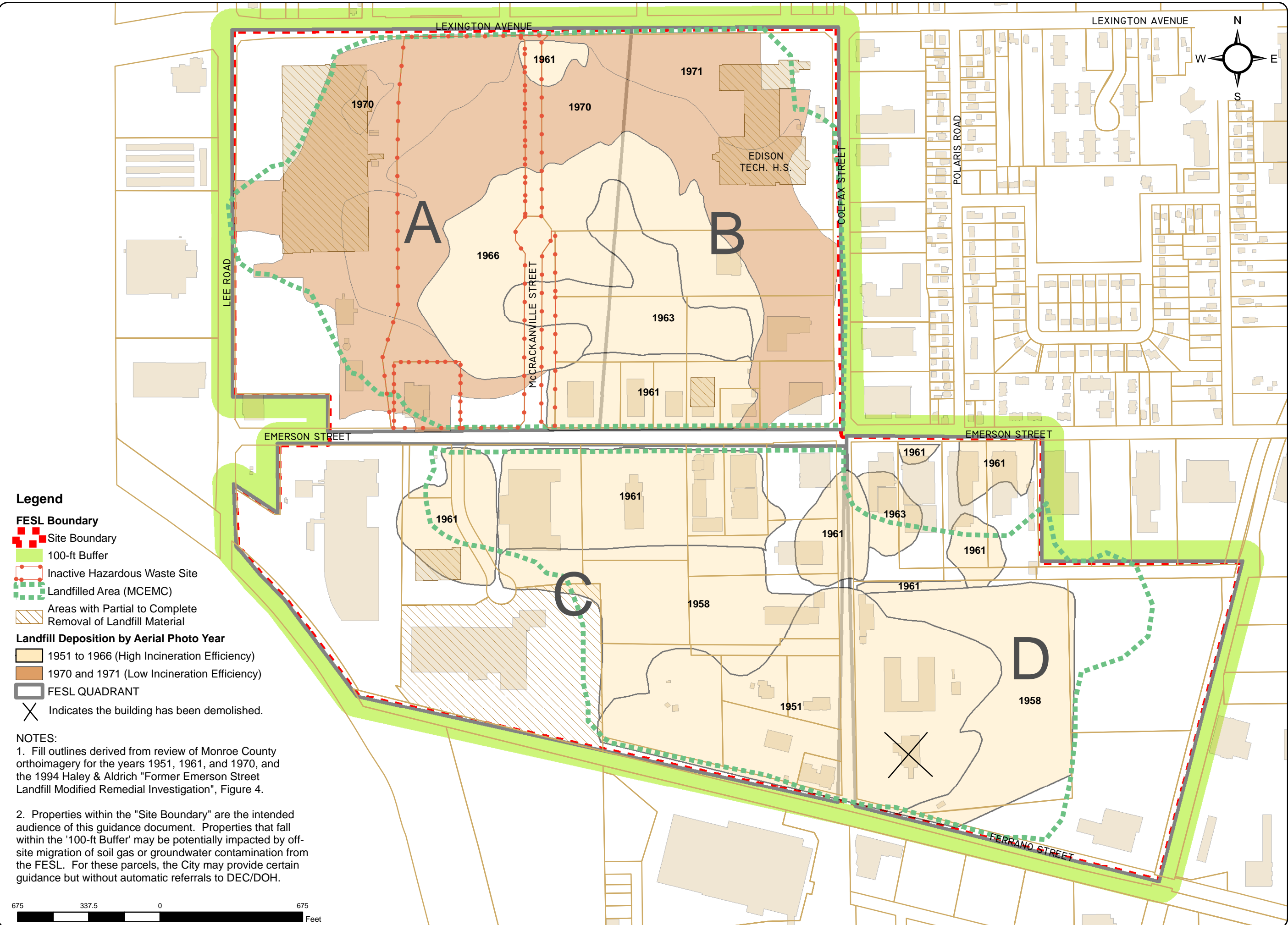

Legend

- FESL Boundary**
- Site Boundary
- 100-ft Buffer
- Inactive Hazardous Waste Site
- Landfilled Area (MCEMC)
- Areas with Partial to Complete Removal of Landfill Material
- Landfill Deposition by Aerial Photo Year**
- 1951 to 1966 (High Incineration Efficiency)
- 1970 and 1971 (Low Incineration Efficiency)
- FESL QUADRANT
- Indicates the building has been demolished.

NOTES:

1. Fill outlines derived from review of Monroe County orthoimagery for the years 1951, 1961, and 1970, and the 1994 Haley & Aldrich "Former Emerson Street Landfill Modified Remedial Investigation", Figure 4.
2. Properties within the "Site Boundary" are the intended audience of this guidance document. Properties that fall within the '100-ft Buffer' may be potentially impacted by off-site migration of soil gas or groundwater contamination from the FESL. For these parcels, the City may provide certain guidance but without automatic referrals to DEC/DOH.

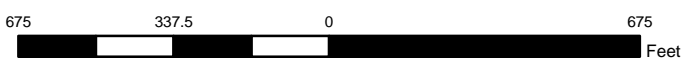

300 STATE STREET
 ROCHESTER, NY 14614
 P: (585) 454-6110
 F: (585) 454-3066
 www.labelpc.com
 COPYRIGHT 2003

LABELLA
 Associates, P.C.

PROJECT CLIENT
 CITY OF ROCHESTER
 FORMER EMERSON STREET LANDFILL
 ROCHESTER, NEW YORK

DRAWING TITLE
 LANDFILL DEPOSITION YEAR

ISSUED FOR:	DESIGNED BY:	RCN
FINAL	DRAWN BY:	RCN
DATE:	REVIEWED BY:	DP
JULY 2007		

FILEPATH: S:\GIS\PROJECTS\FESL\Landfill Deposition\Draw.mxd

PROJECT/DRAWING NUMBER
 207392
 FIGURE 1

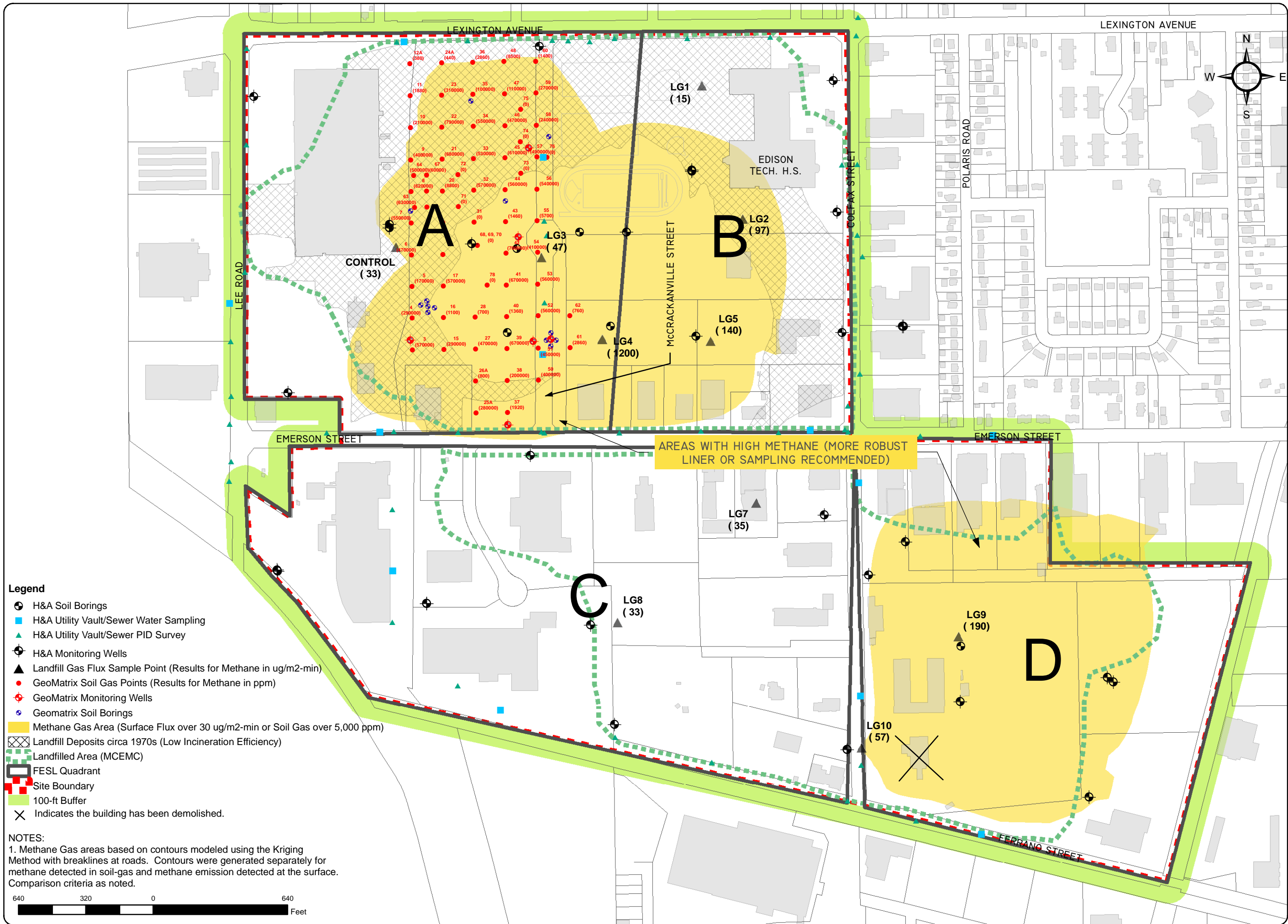

300 STATE STREET
 ROCHESTER, NY 14614
 P: (585) 454-6110
 F: (585) 454-3066
 www.labelpc.com
 COPYRIGHT 2003

LABELLA

Associates, P.C.

PROJECT CLIENT
 CITY OF ROCHESTER
 FORMER EMERSON STREET LANDFILL
 ROCHESTER, NEW YORK

DRAWING TITLE
 HIGH METHANE
 EVOLUTION AREAS

ISSUED FOR	DESIGNED BY	RCN
FINAL	DRAWN BY	RCN
DATE	REVIEWED BY	DPN
MAY 2007		

FILEPATH: S:\GIS\PROJECTS\FESL\GAS\SAMPLES.mxd

PROJECT/DRAWING NUMBER
 207392
 FIGURE 2



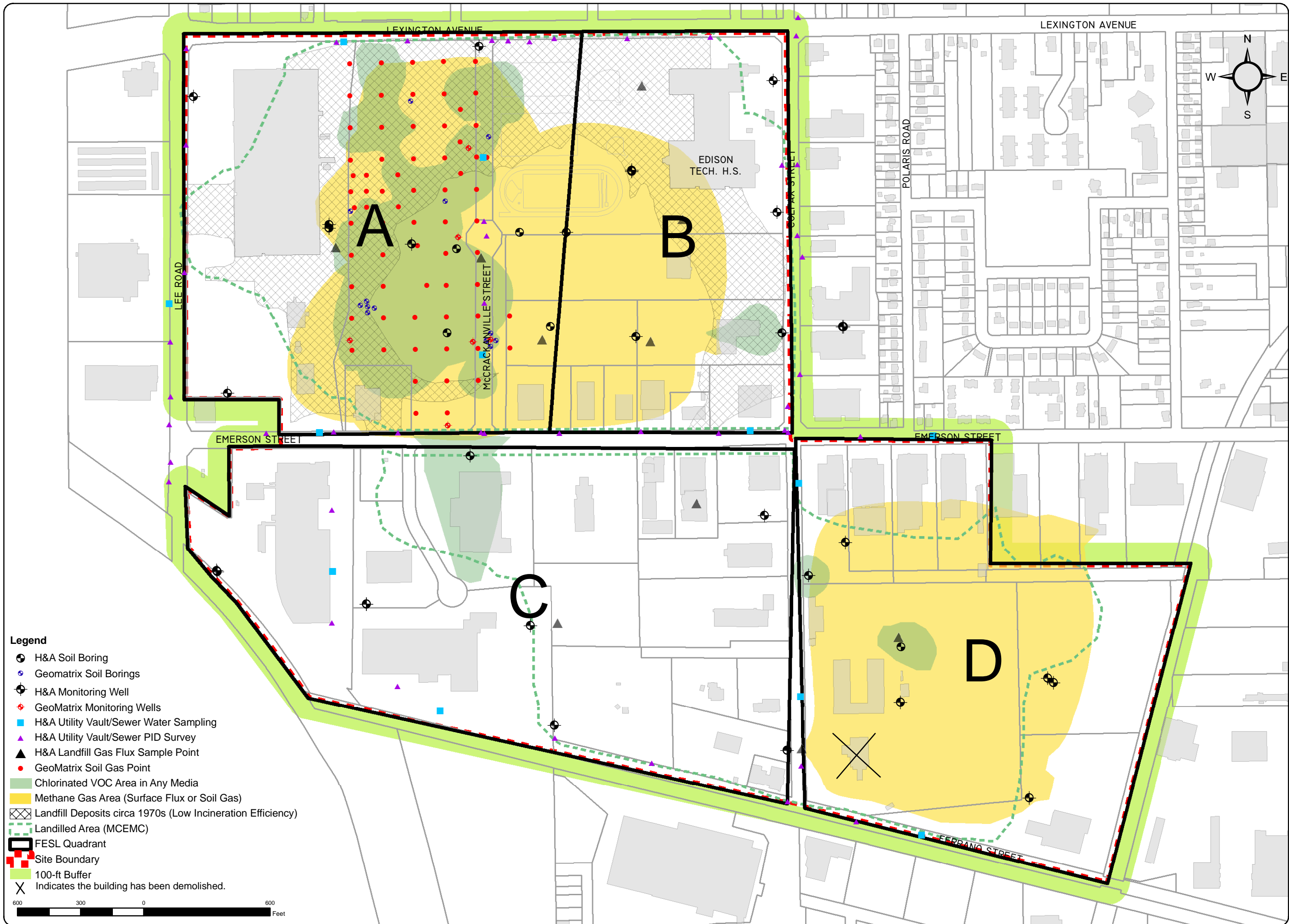

- Legend**
- H&A Soil Boring
 - Geomatrix Soil Borings
 - H&A Monitoring Well
 - GeoMatrix Monitoring Wells
 - H&A Utility Vault/Sewer Water Sampling
 - H&A Utility Vault/Sewer PID Survey
 - H&A Landfill Gas Flux Sample Point
 - GeoMatrix Soil Gas Point
 - Chlorinated VOC Area in Any Media
 - Methane Gas Area (Surface Flux or Soil Gas)
 - Landfill Deposits circa 1970s (Low Incineration Efficiency)
 - Landfilled Area (MCEMC)
 - FESL Quadrant
 - Site Boundary
 - 100-ft Buffer
 - Indicates the building has been demolished.

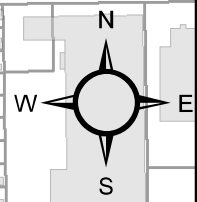

300 STATE STREET
 ROCHESTER, NY 14614
 P: (585) 454-6110
 F: (585) 454-3066
 www.labelppc.com
 COPYRIGHT 2003

LABELLA
 Associates, P.C.

PROJECT/TITLE
 CITY OF ROCHESTER
 FORMER EMERSON STREET LANDFILL
 ROCHESTER, NEW YORK

ISSUED FOR: FINAL
 DATE: MAY 2007
 FILEPATH: S:\GIS\PROJECTS\FESL\land

DESIGNED BY: RCN	RCN
DRAWN BY: RCN	RCN
REVIEWED BY: DPN	DPN

PROJECT/DRAWING NUMBER
 207392
 FIGURE 4

EXAMPLE BUILDING SUB-SLAB
DEPRESSURIZATION SYSTEM LAYOUT
AND TESTING POINTS - PLAN VIEW

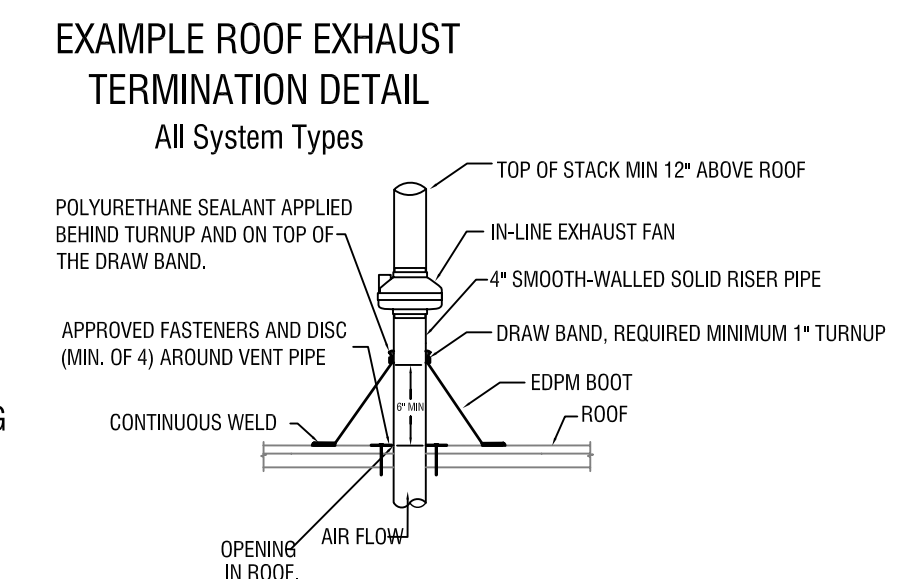
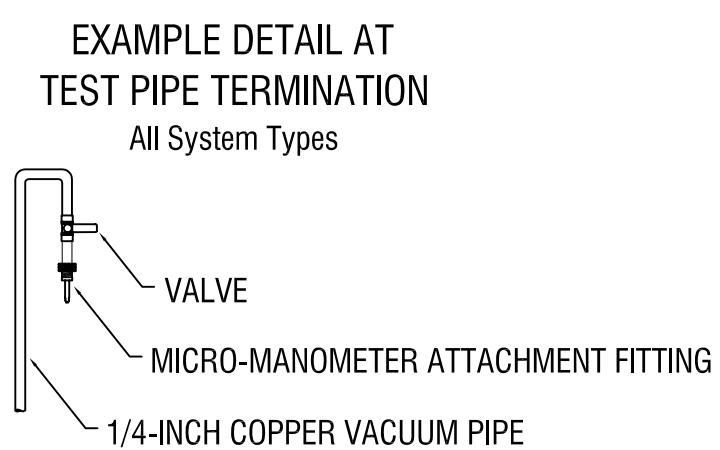
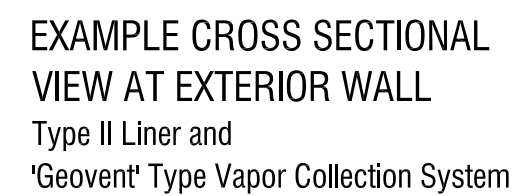
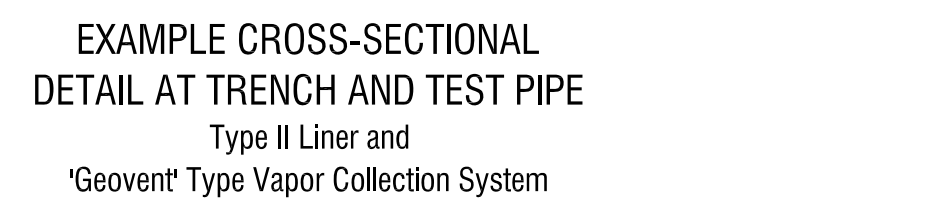
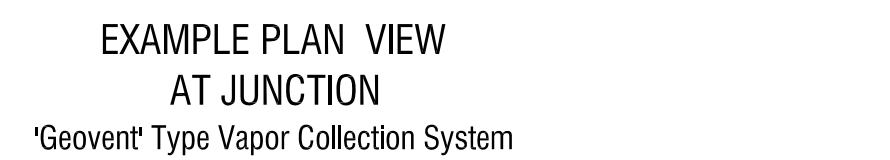
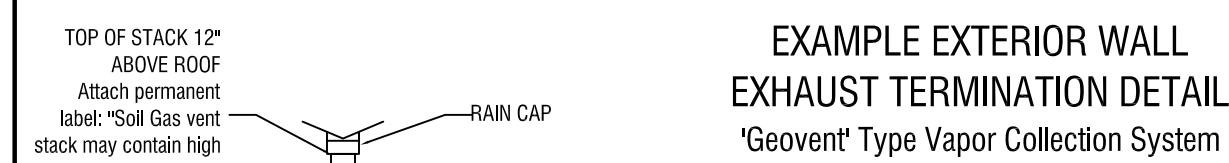
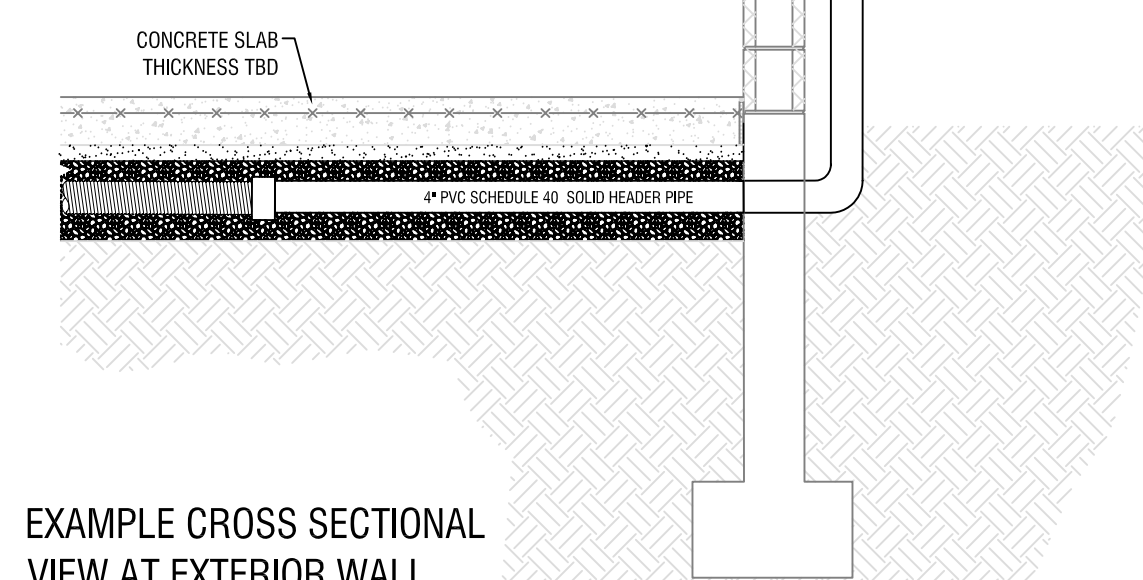
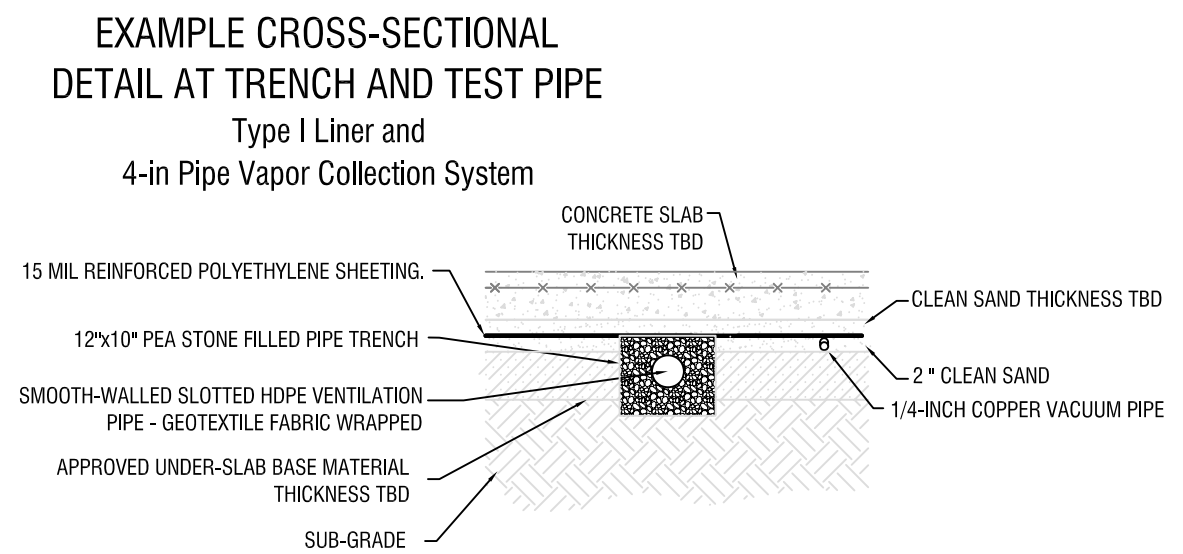
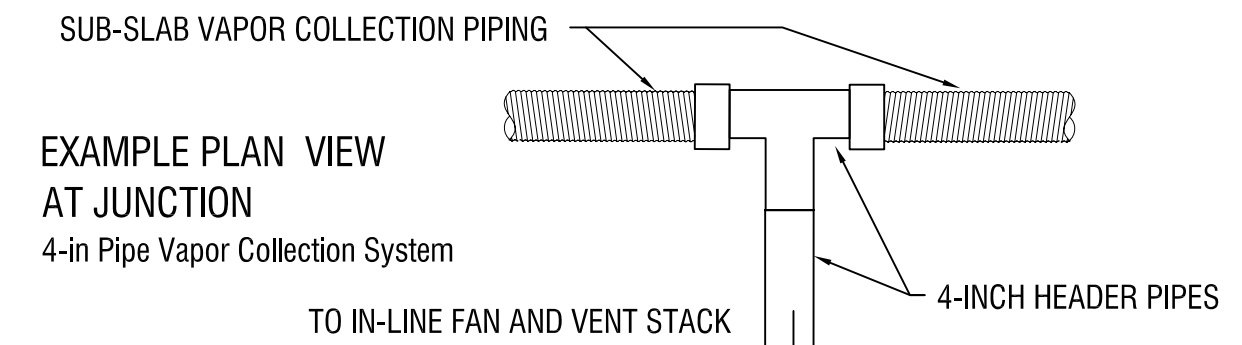
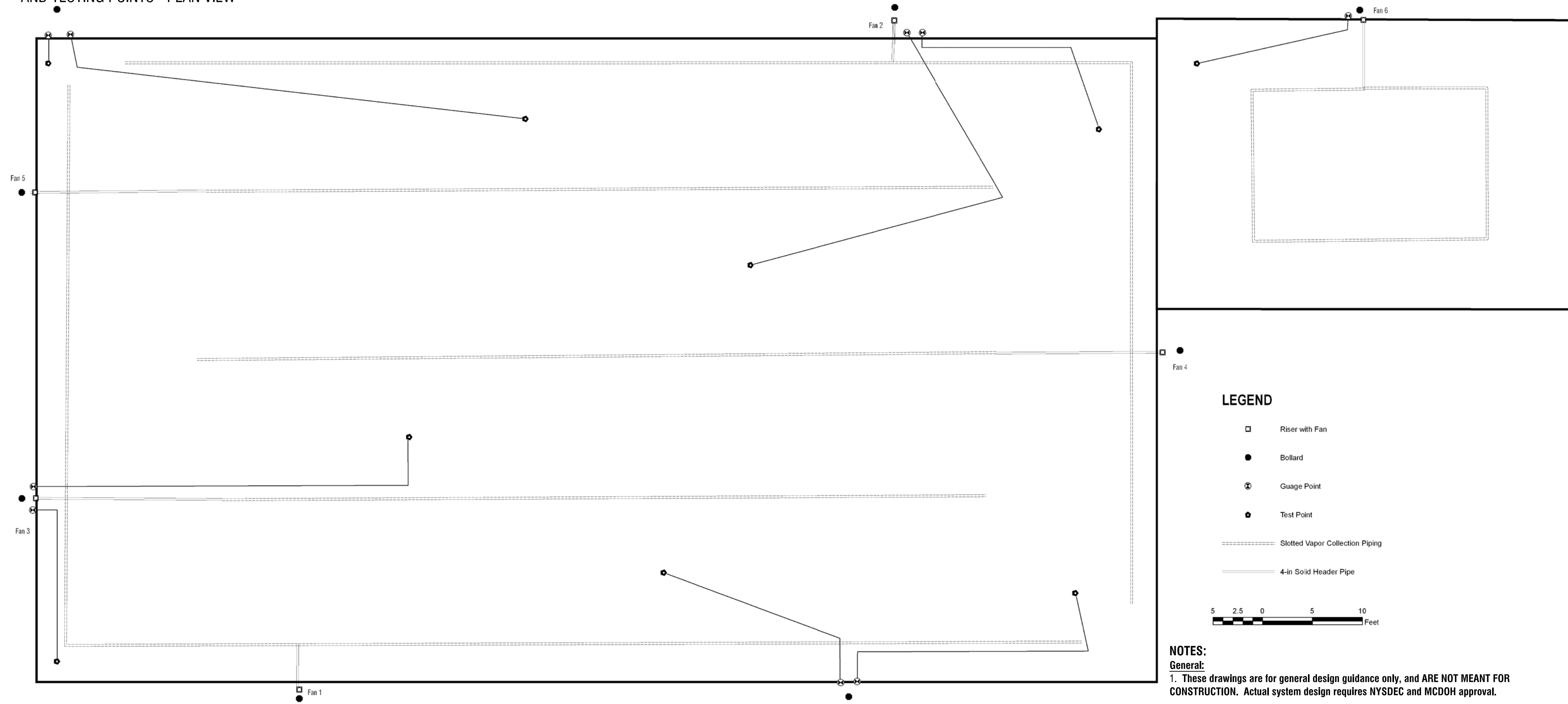

300 STATE STREET
ROCHESTER, NY 14614
P: (585) 454-6110
F: (585) 454-3066
www.labellapc.com

LABELLA
Associates, P.C.

PROJECT CLIENT
CITY OF ROCHESTER
FORMER EMERSON STREET LANDFILL
ROCHESTER, NEW YORK

DRAWING TITLE
GUIDANCE FOR SUB-SLAB VENTILATION SYSTEM & DETAILS

ISSUED FOR: FINAL
DESIGNED BY: RGN
DRAWN BY: RGN
REVIEWED BY: DEP
DATE: JUNE 2007

PROJECT/DRAWING NUMBER
207292

FIGURE 5

Copyright © 2004

EXAMPLE PARKING LOT VENT SYSTEM
PLAN VIEW

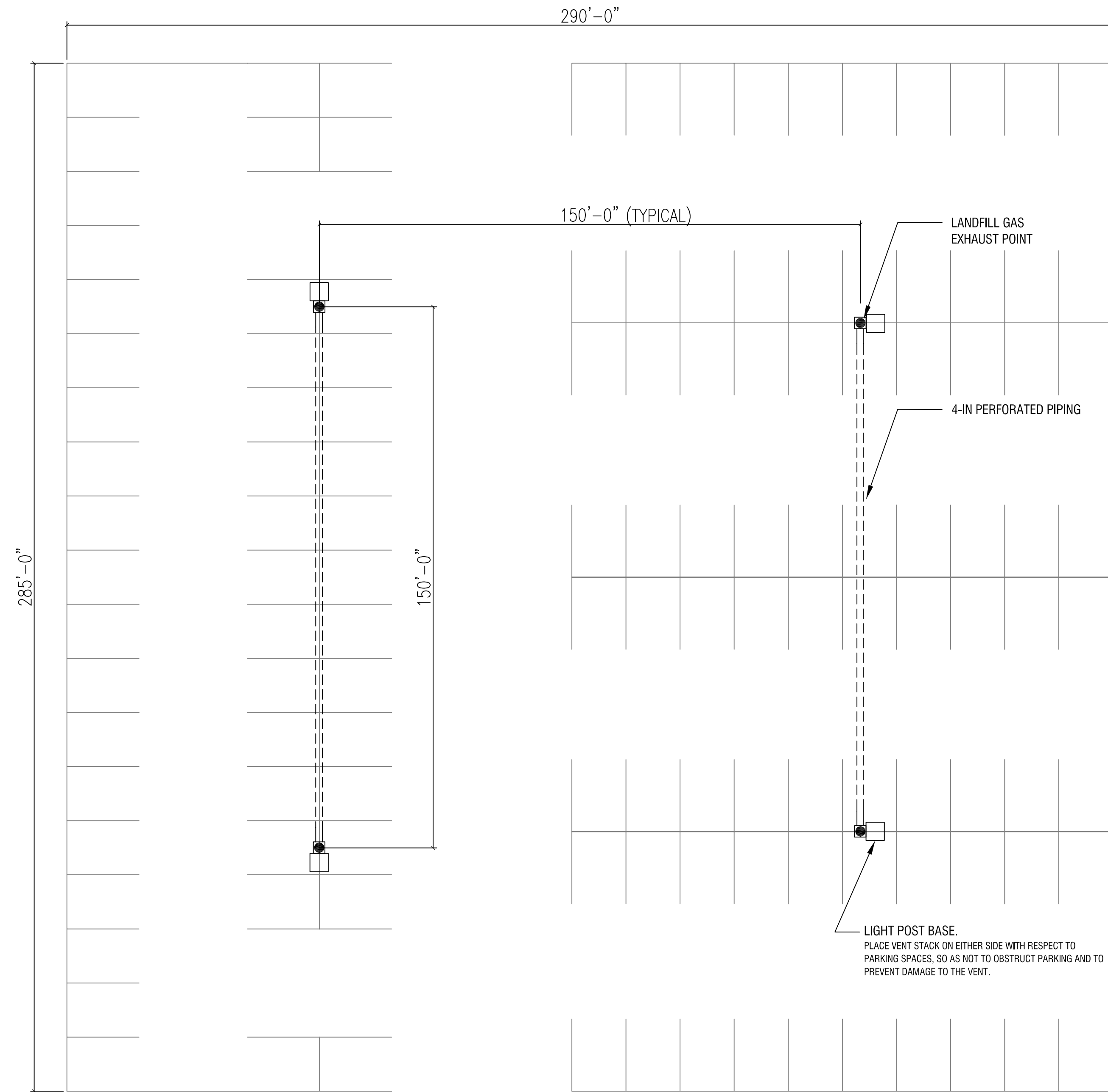

- NOTES:
- Profile sequence may change based on materials specified by the designer. Any alterations to the depicted profile that reduces the layer of permeable material shall be made in coordination with NYSDEC & NYSDOH.
 - PEA STONE shall consist of material that will pass through a 2-inch sieve and be retained by a 1/4-inch sieve.

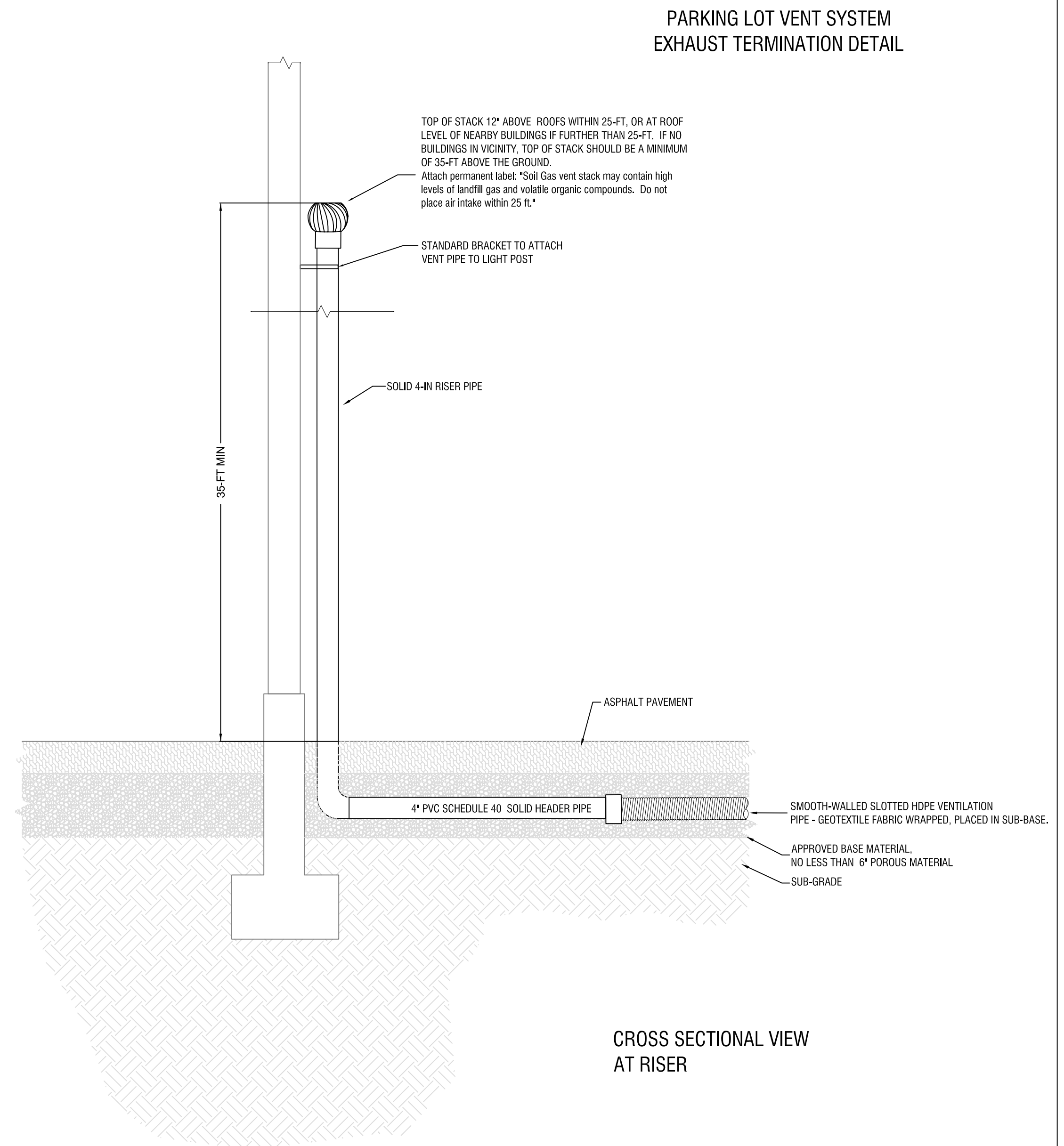

PARKING LOT VENT SYSTEM
EXHAUST TERMINATION DETAIL

CROSS SECTIONAL VIEW
AT RISER

LABELLA
LaBella Associates, P.C.

300 State Street
Rochester, New York 14614

Appendix 9

City of Rochester
Former Emerson Street Landfill (NYSDEC Site #828023)
Annual Certification Form

RETURN BY DECEMBER 15TH TO:
Joseph J. Biondolillo, City of Rochester,
Department of Environmental Services, City Hall
Room 300-B, 30 Church Street
Rochester, New York 14614

Site:	North:	East:
Building No.:	Square Footage:	
Site Acreage:	Construction Date:	
Site Owner:		
Owner Address:	Zip Code:	
City/Town:	State:	
Reporting Period:		
1. Is the information above correct?	YES <input type="checkbox"/>	NO <input type="checkbox"/>
If NO, include handwritten above or on a separate sheet.		
2. Has some or all of the site property been sold, subdivided, merged, or undergone a tax map amendment during this Reporting Period?	<input type="checkbox"/>	<input type="checkbox"/>
3. Has there been any change of use (new tenant, significantly different operations, etc.) at the site during this Reporting Period?	<input type="checkbox"/>	<input type="checkbox"/>
4. Have any federal, state, and/or local permits been issued for or at the property during this Reporting Period (specifically for utility work or work through the floor slab)?	<input type="checkbox"/>	<input type="checkbox"/>
If you answered YES to questions 2 thru 4, please include additional information.		
5. Is the site currently undergoing development or planned for development (any renovation work, changes to building layout, HVAC equipment, etc.)?	<input type="checkbox"/>	<input type="checkbox"/>
6. Are the venting fans operating properly and have the fans been down at any time throughout the year?	<input type="checkbox"/>	<input type="checkbox"/>
Sub-Slab Depressurization System Monitoring, refer to OM&M Plan (Attached any comments on separate sheet, if necessary)		
Fan #1	Fan #2	
System Piping Intact? _____	System Piping Intact? _____	
Manometer Reading = _____	Manometer Reading = _____	
Alarm Functioning (Check)? _____	Alarm Functioning (Check)? _____	
_____ Signature of Property Owner or Designated Representative		_____ Date
Control Description for Site		
<p>The property has the following controls in-place with the City of Rochester:</p> <ul style="list-style-type: none"> • The existing sub-slab depressurization system at the site must be monitored annually and maintained as needed. • All subsurface activities on the property that disturb fill materials must be conducted in accordance with the <i>Guidance for Waste-fill Management During Site Development</i> by H&A of New York as updated by the City in July 1997. • Any new buildings constructed at the Site must have a sub-slab depressurization system installed in accordance with the <i>Sub-Slab Ventilation Guidance Document Update 2007</i> by LaBella Associates dated November 2007 and the NYSDOH 2006 Guidance (or the most recent Guidance from these agencies). • The use of the groundwater underlying the property is prohibited without written approval from the City of Rochester and NYSDEC/NYSDOH. 		

LABELLA
LaBella Associates, P.C.

300 State Street
Rochester, New York 14614

Appendix 10



VAPOR INTRUSION SCREENING LEVEL (VISL) CALCULATOR

USER'S GUIDE

U.S. ENVIRONMENTAL PROTECTION AGENCY
OFFICE OF SOLID WASTE AND EMERGENCY RESPONSE
OFFICE OF SUPERFUND REMEDIATION AND TECHNOLOGY INNOVATION
WASHINGTON, D.C. 20460

May 2014

DISCLAIMER

This document describes the calculation of recommended, but not mandatory, screening levels for use in evaluating the vapor intrusion pathway at Comprehensive Environmental Response, Compensation and Liability Act (CERCLA) and Resource Conservation and Recovery Act (RCRA) sites. These screening levels are calculated using the recommended approaches in existing guidance. The information provided in this document does not impose any requirements or obligations on the U.S. Environmental Protection Agency (EPA) or on the owner/operators of sites that may be contaminated with volatile and toxic compounds. Alternative approaches for evaluating the vapor intrusion pathway may be found to be more appropriate at specific sites (for example, where site circumstances do not match the underlying assumptions used in calculating the screening levels).

VAPOR INTRUSION SCREENING LEVEL (VISL) CALCULATOR USER'S GUIDE

Overview

The Vapor Intrusion Screening Level (VISL) Calculator is a spreadsheet tool that (1) lists chemicals considered to be volatile and known to pose a potential cancer risk or noncancer hazard through the inhalation pathway; (2) provides generally recommended screening-level concentrations for groundwater, soil gas (exterior to buildings and sub-slab) and indoor air for default target risk levels and exposure scenarios; and (3) allows calculation of site-specific screening levels based on user-defined target risk levels and exposure scenarios. The VISL Calculator can assist Comprehensive Environmental Response, Compensation and Liability Act (CERCLA) remedial project managers (RPMs) and on-scene coordinators (OSCs), as well as Resource Conservation and Recovery Act (RCRA) project managers in determining whether the vapor intrusion (VI) pathway has the potential to pose an unacceptable level of risk to human health by: (1) identifying whether chemicals that can pose a risk through VI are present; (2) determining if those chemicals are present at explosive levels; and (3) comparing subsurface or indoor data against screening levels provided in the Calculator. The screening level concentrations in the Calculator are not intended to be used as cleanup levels, nor are they intended to supersede existing criteria of the lead regulatory authority.

The VISLs are calculated using the recommended approaches in existing guidance and are based on current understanding of the vapor intrusion pathway. Target indoor air concentrations are calculated according to the guidance provided in Risk Assessment Guidance for Superfund (RAGS) F (EPA 2009), which does not support the route-to-route extrapolations that were used in the now outdated screening tables in the EPA's November 2002 draft vapor intrusion guidance (EPA 2002). The screening levels for groundwater and soil gas (either sub-slab gas or soil gas collected exterior to buildings) are calculated from the target indoor air concentrations using empirically-based conservative "generic" attenuation factors that reflect generally reasonable worst-case conditions as described in the EPA's draft vapor intrusion guidance (EPA 2002). The default, generic VISLs are based on default exposure parameters and factors that represent Reasonable Maximum Exposure (RME) conditions for long-term/chronic exposures. Site-specific criteria that can be input to the calculator include exposure scenario (either residential or commercial), target risk for carcinogens, target hazard quotient for noncarcinogens and average in situ groundwater temperature (stabilized temperature measured during well purging prior to groundwater sampling). The VISL Calculator incorporates the latest toxicity values in the Regional Screening Levels (RSL) tables (EPA, "Regional Screening Levels") and will be updated as new versions of the RSL tables are released¹.

Applicability of the VISL Calculator

The purpose of the VISL calculator is to provide a tool to assist RPMs, OSCs, risk assessors and others involved in decision-making concerning CERCLA hazardous waste sites and to determine whether levels of contamination found at the site may warrant further investigation or site cleanup, or whether no further investigation or action may be required.

¹ EPA Regional Screening Level (RSL) tables are updated semi-annually with the latest version available online at http://www.epa.gov/reg3hwmd/risk/human/rb-concentration_table/index.htm. The Vapor Intrusion Screening Level (VISL) Calculator will be revised accordingly to reflect the most recent information available.

Users within and outside the CERCLA program should use the calculator results at their own discretion, and they should take care to understand the assumptions incorporated in these results and to apply the screening levels appropriately.

The screening levels presented in the calculator are chemical-specific concentrations for individual contaminants in air that may warrant further investigation or site cleanup. The screening levels generated from the calculator may be site-specific concentrations for individual chemicals in air. It should be emphasized that screening levels are not cleanup standards. It is not recommended that the VISLs be used as cleanup levels for Superfund Sites until the recommendations in EPA's Supplemental Guidance to Risk Assessment Guidance for Superfund, Volume I, Part A, Community Involvement in Superfund Risk Assessments (EPA 1999) have been addressed. Screening levels should not be used as cleanup levels for a CERCLA site until the other remedy selections identified in the relevant portions of the National Contingency Plan (NCP), 40 CFR Part 300, have been evaluated and considered.

The subsurface target concentrations in the VISL Calculator are based on the generic conceptual model for vapor intrusion described in EPA's draft vapor intrusion guidance. This conceptual model assumes a groundwater or vadose zone source of volatile vapors that diffuse upwards through unsaturated soils towards the surface and into buildings. In this model, the soil in the vadose zone is considered to be relatively homogeneous and isotropic, though horizontal layers of soil types can be accommodated. The receptors are assumed to be occupants in buildings with poured concrete foundations (for example, basement or slab on grade foundations or crawlspaces with a liner or other vapor barrier). The underlying assumption for this generic model is that site-specific subsurface characteristics will tend to reduce or attenuate vapor concentrations as vapors migrate upward from the source and that site-specific building characteristics will tend to further dilute the vapors as they mix with the air in the building. The generic attenuation factors were developed based on analysis of VI data in EPA's VI database (EPA 2002, 2008).

In general, it is recommended that the user consider whether the assumptions underlying the generic conceptual model are applicable at each site, and use professional judgment to make whatever adjustments (including not considering the model at all) are appropriate. Specific factors that may result in unattenuated or enhanced transport of vapors towards a receptor, and consequently are likely to render the VISL screening target subsurface concentrations inappropriate, include:

- Very shallow groundwater sources (for example, depths to water less than 5 ft below foundation level);
- Shallow soil contamination vapor sources (for example, sampled at levels within a few feet of the base of the foundation)
- Buildings with significant openings to the subsurface (for example, sumps, unlined crawlspaces, earthen floors) or significant preferential pathways, either naturally-occurring or anthropogenic (not including typical utility perforations present in most buildings).

Description and Use of VISL Calculator

The VISL Calculator contains nine worksheets:

Navigation Guide: Provides information regarding the Calculator's contents and structure, including a data field dictionary (see "Navigation Guide" tab in the VISL Calculator) that describes each data field and any formulas used to calculate the contents of the data field.

VISL: Main worksheet where the user can enter the exposure scenario and risk information and select chemicals to calculate the screening-level values for groundwater, soil gas (sub-slab and exterior soil gas) and indoor air.

SG IA calc: Worksheet where the user can enter the exposure scenario and site soil gas (sub-slab and exterior soil gas) concentrations to calculate the indoor air concentrations and the resulting risk values for indoor air.

GW IA calc: Worksheet where the user can enter the exposure scenario and site groundwater concentrations to calculate the indoor air concentrations and the resulting risk values for indoor air.

IA risk calc: Worksheet where the user can enter the exposure scenario and site indoor air concentrations to calculate resulting risk values for indoor air.

ChemProps: Supporting worksheet that contains a compilation of physical and chemical properties of each chemical, which are used in the calculations for the VISL worksheet.

Version Notes: Worksheet to track the changes made in each version of the VISL calculator workbook.

Tox Summary: Supporting worksheet that provides a list of contaminants, toxicity values, maximum contaminant levels (MCLs) and the lesser (more protective) of the cancer and noncancer screening levels (SLs) for resident soil, industrial soil, resident air, industrial air and tap water from EPA's RSL website (EPA, "Regional Screening Levels").

Parameters Summary: Supporting worksheet that contains physical and chemical properties from EPA's RSL website (EPA, "Regional Screening Levels"). The properties in this worksheet are linked to the ChemProps worksheet.

The list of chemicals included in the VISL calculator includes all chemicals denoted as volatile in the RSL tables by the "voc" field, and for which either an inhalation unit risk (IUR) or a reference concentration (RfC) is listed in the RSL tables.

The VISL Calculator allows the user to enter the exposure scenario (residential or commercial), target risk for carcinogens, target hazard quotient for noncarcinogens and average in situ groundwater temperature, if appropriate. Default values are provided for all these entries. For site-specific exposure scenarios, the worksheet can be unprotected to change the exposure parameters.

The Calculator uses chemical property and toxicity information to determine whether a chemical, if present in soil, is sufficiently volatile and toxic to pose an inhalation risk through vapor intrusion and

whether a chemical, if present in groundwater, is sufficiently volatile and toxic to pose an inhalation risk through vapor intrusion at the selected cancer risk or hazard quotient levels.

For a soil source, a chemical is considered sufficiently volatile and toxic to pose an inhalation risk through vapor intrusion if the vapor pressure (expressed in terms of vapor concentration using the ideal gas law) of the pure component is greater than the target indoor air concentration. The soil gas attenuation factor is not considered in this comparison, although it is considered in the subsequent calculation of the target soil gas concentration.

For a groundwater source, a chemical is considered sufficiently volatile and toxic to pose an inhalation risk through vapor intrusion if the vapor concentration (calculated using the chemical's Henry's Law Constant at the groundwater temperature) corresponding to the chemical's solubility limit in water, is greater than the target indoor air concentration. The groundwater attenuation factor is not considered in this comparison, although it is considered in the subsequent calculation of the target groundwater concentration.

The soil gas attenuation factor used in the calculations is 0.1, which is the generic attenuation factor used for sub-slab gas in the 2002 draft vapor intrusion guidance. This attenuation factor is used for all soil gas data, as additional information collected after development of the 2002 draft vapor intrusion guidance (EPA 2002) suggests that external soil gas samples need to be evaluated as conservatively as sub-slab gas samples (EPA 2010).

The groundwater attenuation factor used in the calculations is 0.001, which is the generic attenuation factor used for groundwater concentrations (expressed in terms of vapor concentration in equilibrium with groundwater concentration) in the 2002 draft vapor intrusion guidance (EPA 2002). Additional information gathered since release of the 2002 draft vapor intrusion guidance (EPA 2002) suggests the 2002 generic groundwater attenuation factor remains valid (EPA 2010).

Data Sources

The chemical property and toxicity information used in the VISL Calculator is obtained from the EPA's RSL website at http://www.epa.gov/reg3hwmd/risk/human/rb-concentration_table/index.htm (EPA, "Regional Screening Levels").

Target Indoor Air Concentration to Satisfy Both the Prescribed Cancer Risk Level and the Target Hazard Index (Column F).

The target breathing zone indoor air concentrations in the VISL Calculator are risk-based screening levels for ambient air. The indoor air concentrations for noncarcinogens and carcinogens are calculated following an approach consistent with the EPA's RAGS F (EPA 2009). The toxicity values used as the basis for the calculations are from the EPA's RSLs, which also include the source of the toxicity data. Separate carcinogenic and noncarcinogenic target concentrations are calculated for each compound when both unit risks and reference concentrations are available. For carcinogens, target indoor air concentrations are based on an adult residential exposure scenario and assume exposure of an individual for 350 days per year over a period of 70 years. For noncarcinogens, target indoor air concentrations are based on the corresponding reference concentration.

For carcinogens, the equation for $C_{ia,c}$, the target indoor air concentration based on cancer toxicity (Column V), is:

$$C_{ia,c} = \frac{TCR \times AT_c \times \left(\frac{365 \text{ days}}{\text{year}}\right) \times \left(\frac{24 \text{ hours}}{\text{day}}\right)}{EF \times ED \times ET \times IUR}$$

where AT_c , EF , ED and ET are the default exposure parameters for residential or commercial exposure as appropriate, and:

TCR	=	Target cancer risk (for example, 1.0×10^{-6})
IUR	=	Inhalation unit risk ($\mu\text{g}/\text{m}^3$) ⁻¹

For carcinogens with mutagenic mode-of-action (MMOA), the equation is slightly modified in accordance with the RSL User's Guide (EPA, "Regional Screening Levels").

$$C_{ia,c} = \frac{TCR \times AT_c \times \left(\frac{365 \text{ days}}{\text{year}}\right) \times \left(\frac{24 \text{ hours}}{\text{day}}\right)}{EF \times ED_{MMOA} \times ET \times IUR}$$

where ED_{MMOA} is calculated with the equation:

$$ED_{MMOA} = (ED_{0-2} \times AF_{0-2}) + (ED_{2-6} \times AF_{2-6}) + (ED_{6-16} \times AF_{6-16}) + (ED_{16-30} \times AF_{16-30})$$

and

ED_{x-y}	=	Exposure duration for the age cohort from age x to y
AF_{x-y}	=	Age-dependent adjustment factor, which is 10 for ages 0 to 2, 3 for ages 2 to 6 and 6 to 16 and 1 for ages 16 to 30

For trichloroethylene, which has mutagenic and non-mutagenic components of the IUR, two $C_{ia,c}$ values are calculated using the mutagenic and non-mutagenic components of the IUR. The reciprocal of the sum of the reciprocals of those $C_{ia,c}$ values is used to calculate the final $C_{ia,c}$ value, in accordance with the EPA RSL guidance (EPA, "Regional Screening Levels").

For vinyl chloride, a slightly modified version of the equation for $C_{ia,c}$ is used (EPA, "Regional Screening Levels"):

$$C_{ia,c} = \frac{TCR}{\left(IUR + \frac{EF \times ED \times ET \times IUR}{AT_c \times \left(\frac{365 \text{ days}}{\text{year}}\right) \times \left(\frac{24 \text{ hours}}{\text{day}}\right)} \right)}$$

For non-carcinogens, the equation for $C_{ia,nc}$, the target indoor air concentration based on non-cancer toxicity (Column W), is:

$$C_{ia,nc} = \frac{THQ \times RfC \times AT_{nc} \times \left(\frac{365 \text{ days}}{\text{year}}\right) \times \left(\frac{24 \text{ hours}}{\text{day}}\right) \times \left(\frac{1000 \mu\text{g}}{\text{mg}}\right)}{EF \times ED \times ET}$$

where AT_{nc} , EF , ED and ET are the default exposure parameters for residential or commercial exposure as appropriate, and:

THQ	=	Target hazard quotient (for example, 1.0)
RfC	=	Reference concentration (mg/m_3)

The more stringent (minimum) of the cancer- and noncancer-based contaminant concentrations is chosen as the target indoor air concentration ($C_{\text{target},ia}$) that satisfies both the prescribed cancer risk level and the target hazard quotient.

If $C_{\text{target},ia}$ exceeds the maximum possible pure chemical vapor concentration, the designation NVT (not sufficiently volatile and/or toxic to pose inhalation risk) is entered in the target indoor air concentration column of the table (Column F).

The vapor concentrations in the VISL Calculator are given in units of micrograms per cubic meter ($\mu\text{g}/\text{m}^3$). Although the VISL Calculator uses these units for all vapor concentrations, some users may have results in parts per billion by volume (ppbv). The conversion from ppbv to $\mu\text{g}/\text{m}^3$ is:

$$C[\text{ppbv}] = \frac{C \left[\frac{\mu\text{g}}{\text{m}^3}\right] \times \left(\frac{10^9 \text{ ppbv}}{\text{atm}}\right) \times \left(\frac{10^{-3} \text{ m}^3}{\text{L}}\right) \times R \times T}{MW \times \left(\frac{10^6 \mu\text{g}}{\text{g}}\right)}$$

where:

R	=	Universal gas constant (0.082057 L-atm/mole-degrees Kelvin)
T	=	Absolute temperature (298.15 K)
MW	=	Molecular weight (grams [g]/mole)

Target Sub-Slab and Exterior Soil Gas Concentration Corresponding to Target Indoor Air Concentration (Column H)

The target soil gas concentration corresponding to a chemical's target indoor air concentration at the selected target cancer risk or hazard quotient is calculated by dividing the indoor air concentration by the generic attenuation factor of 0.1.

$$C_{\text{soil-gas}} = \frac{C_{\text{target},ia}}{AF_{SS}}$$

where:

$C_{\text{soil-gas}}$	=	Target soil gas concentration [$\mu\text{g}/\text{m}^3$]
AF_{SS}	=	Attenuation factor (ratio of indoor air concentration to sub-slab or soil gas concentration; default value is 0.1)

If $C_{\text{soil-gas}}$ exceeds the maximum possible pure chemical vapor concentration at 25°C, but $C_{\text{target,ia}}$ does not exceed the maximum possible pure chemical vapor concentration, then NVT is entered in the table under target sub-slab or soil gas concentration (Column H).

Target Groundwater Concentration Corresponding to Target Indoor Air Concentration (Column I)

The target groundwater concentration corresponding to a chemical's target indoor air concentration is calculated by dividing the target indoor air concentration by an attenuation factor of 0.001 and then converting the vapor concentration to an equivalent groundwater concentration, assuming equilibrium between the aqueous and vapor phases at the water table. The equilibrium partitioning is assumed to obey Henry's Law so that:

$$C_{gw} = \frac{C_{\text{target,ia}}}{HLC \times AF_{gw} \times \left(\frac{1000 L}{m^3}\right)}$$

where:

C_{gw}	=	Target groundwater concentration (micrograms per liter [$\mu\text{g/L}$])
$C_{\text{target,ia}}$	=	Target indoor air concentration ($\mu\text{g/m}^3$)
AF_{gw}	=	Attenuation factor (ratio of indoor air concentration to groundwater concentration; the default value is 0.001)
HLC	=	Dimensionless Henry's Law Constant at the specified groundwater temperature [(milligrams per liter (mg/L) – vapor)/(mg/L – H ₂ O)]

The following equation can be used to calculate the Henry's Law Constant at a groundwater temperature of 25 degrees Celsius:

$$H'_{25} = \frac{Hc_{25} \times \left(\frac{1000 L}{m^3}\right)}{R \times (298.15 K)}$$

where:

H'_{25}	=	Dimensionless Henry's Law Constant at 25 degrees Celsius
Hc_{25}	=	Henry's Law Constant at 25 degrees Celsius (atm·m ³ per mole)
R	=	Universal gas constant (0.082057 L·atm/mol·degrees Kelvin)

For groundwater temperatures other than 25 degrees Celsius, the following equation is used to calculate Henry's Law Constant:

$$H'_{T_{gw}} = Hc_{25} \times \exp \left[\left(\frac{DH_{v,b}}{RC} \right) \times \frac{\left(1 - \frac{T_{gw}}{T_{crit}}\right)}{\left(1 - \frac{T_{boil}}{T_{crit}}\right)} \right]^n \times \left[\left(\frac{1}{T_{gw}} \right) - \left(\frac{1}{298.15 K} \right) \right]$$

where:

$H'T_{gw}$	=	Dimensionless Henry's Law Constant at the groundwater temperature
Hc_{25}	=	Henry's Law Constant at 25 degrees Celsius (atm-m ³ per mole)
$DH_{v,b}$	=	Enthalpy of vaporization at the normal boiling point (cal/mol)
RC	=	Universal gas constant (1.9872 cal/mol-K)
T_{gw}	=	Groundwater temperature (degrees Kelvin)
T_{crit}	=	Critical temperature (degrees Kelvin)
T_{boil}	=	Normal boiling point (degrees Kelvin)
n	=	If $(T_{boil}/T_{crit} < 0.57)$, $n = 0.3$ If $(T_{boil}/T_{crit} > 0.71)$, $n = 0.41$ If $(0.57 < T_{boil}/T_{crit} \leq 0.71)$, $n = (0.74 \times T_{boil}/T_{crit} - 0.116)$

For some chemicals, the parameters required to calculate $H'T_{gw}$ are not available. In these cases, the Henry's Law Constant at 25 degrees Celsius is used instead. The temperature assumed for each chemical is listed as the temperature for groundwater vapor concentration (Column M).

If $C_{target,ia}$ is determined to be NVT, NVT is entered as the target groundwater concentration (Column I). If C_{gw} exceeds the aqueous solubility of the pure chemical, but $C_{target,ia}$ does not exceed the maximum possible pure chemical vapor concentration, then NVT is entered in the table under this column (Column I).

For informational purposes, the calculated groundwater target concentration is compared with the MCL for the compound in Column J.

References

EPA. (1999). "Risk Assessment Guidance for Superfund, Volume I: Human Health Evaluation Manual Supplement to Part A: Community Involvement in Superfund Risk Assessments." EPA 540-R-98-042. March. http://www.epa.gov/oswer/riskassessment/ragsa/pdf/ci_ra.pdf

EPA. (2002). "OSWER Draft Guidance for Evaluating the Vapor Intrusion to Indoor Air Pathway from Groundwater and Soils (Subsurface Vapor Intrusion Guidance)." Office of Solid Waste and Emergency Response. Washington, DC. EPA 530-D-02-004. November. www.epa.gov/osw/hazard/correctiveaction/eis/vapor/complete.pdf

EPA. (2008). "Draft US EPA's Vapor Intrusion Database: Preliminary Evaluation of Attenuation Factors." Office of Solid Waste and Emergency Response. March 4. iavi.rti.org/OtherDocuments.cfm?PageID=documentDetails&AttachID=369

EPA. (2009). "Risk Assessment Guidance for Superfund, Volume I: Human Health Evaluation Manual (Part F, Supplemental Guidance for Inhalation Risk Assessment)." EPA 540-R-070-002. January. www.epa.gov/oswer/riskassessment/ragsf/pdf/partf_200901_final.pdf

EPA. (2010). Review of the Draft 2002 Subsurface Vapor Intrusion Guidance. Office of Solid Waste and Emergency Response. www.epa.gov/oswer/vaporintrusion/documents/review_of_2002_draft_vi_guidance_final.pdf

EPA. "Regional Screening Levels for Chemical Contaminants at Superfund Sites." Latest edition. www.epa.gov/reg3hwmd/risk/human/rb-concentration_table/index.htm

LABELLA
LaBella Associates, P.C.

300 State Street
Rochester, New York 14614

Appendix 11

**FORMER EMERSON STREET LANDFILL
SOIL VAPOR INTRUSION
PRELIMINARY BUILDING ASSESSMENT AND SITE RECONAISSANCE**

Parcel Information:

Address: _____

Owner: _____

Number of Buildings: _____

Building this Sheet Represents (*fill out one for each building*): _____

Interviewer Information:

Name: _____ Date/Time Prepared: _____

Consultant Firm: _____ Phone No.: _____

Owner/Interviewee Information:

Last Name: _____ First Name: _____

Address: _____

Company: _____

Office Phone: _____

Tenant Information (if any):

Tenant Contact Person: _____

Address: _____

Company: _____

Office Phone: _____

SECTION I - Building Construction Information

A. Site plans available? (e.g., foundation construction, utility locations/chases, etc.): Yes/No

If yes, can copies be obtained? _____

B. Does owner have knowledge that ash or solid waste was removed at time of building construction: Yes/No

If yes, are any documents available? _____

C. Building Construction

	Construction Type	Finish Type	Sealed	Square Feet
Basement				
Crawl Space				
First Floor				
Foundation Walls				
2nd Floor				

D. Any additions to building: Yes/No

If yes, list dates and locations: _____

If yes, note variations in construction: _____

E. Utility/Floor Penetrations

	Location(s)	Size/Description
Electric		
Gas		
Water		
Sewer/Wastewater		
Sumps		
Floor/Trench Drains		
Dry Well		
Oil/Water Separators		
Cracks in Floor		
Expansion Joints		
Floating Slab		
Monitoring Points		
Scales		
Utility Vaults		
Elevators		
Other		

F. Does facility have an on-Site septic system? Yes/No

If yes, where and size: _____

G. Does facility provide pretreatment of wastewater prior to discharge to sanitary sewer? Yes/No

If yes, What type of pretreatment is conducted: _____

H. Is there a vapor barrier associated with the foundation system? Yes/No

If yes, indicate type/material, location, thickness, etc.: _____

I. Is there a radon/sub-slab soil vapor mitigation system on any portion of the building? Yes/No

If yes, describe system and date installed: _____

If yes, Is the system active or passive? _____

If yes, Is system currently operational? _____

J. Standing water or wet areas in lower levels? Yes/No

If yes, list location and describe: _____

If yes, how frequent: less than 1/yr; 1-2 times/yr; or, more than 3 times/yr

K. Is the building insulated? Yes/No

If yes, location(s) and type? _____

L. Are there any settlement issues with the building? Yes/No

If yes, describe: _____

M. Are there any cracks in floor slabs (1st floor or basement)?

If yes, location(s), width, etc.? _____

N. Are there any elevators in the building? Yes/No

If yes, describe construction and condition of pit (poured concrete, cinder block, etc.) _____

Comments:

SECTION II – Heating, Ventilation and Air Conditioning Information

A. Type of heating system(s) used in this building: *(circle all that apply - note primary)*

- Forced hot air Heat pump Hot water baseboard
 Space Heaters Stream radiation Radiant floor
 Electric baseboard Other: _____

For each heat system/unit, provide the following:

Unit Type	Unit Location	Areas Heated	Unit Size	Pressurization (neg. vs. positive)	Air Communication with other areas (duct work, doors, etc.)

B. Type of fuel used: *(circle all that apply)*

- Natural Gas Fuel Oil Kerosene
 Electric Propane Solar
 Wood Coal Other: _____

If more than one list locations: _____

C. Domestic hot water tank fueled by: _____

D. Air conditioning: Central Air Window units None

Comments:

SECTION III – Indoor Air Quality Influence Factors

A. Is there a garage, service area, or manufacturing area in building? Yes/No

If yes, list all that apply: _____

1. Does the garage, service or manufacturing areas have separate heating unit/system? Yes/No/NA

2. Are petroleum-powered machines or vehicles used or stored within the garage, service area or manufacturing area of building? (e.g., forklifts, vehicle fleet, lawnmower, etc.) Yes/No/NA

If yes, specify: _____

B. Are there any current or former USTs, ASTs or Fueling Facilities on the property? Yes/No

If yes, specify location: _____

C. Are there any current or former hydraulic lifts at the property? Yes/No

If yes, locations and note if underground or above ground: _____

D. Are there any current or former petroleum or chemical spills at the Site? Yes/No

If yes, specify location, quantity, material and date: _____

E. Are there any current or former groundwater monitoring wells at the Site? Yes/No

If yes, specify location and accessibility: _____

F. Has the building ever had a fire? Yes/No

If yes, When: _____

G. Is there a maintenance area? Yes/No

If yes, Where: _____

H. Are there any parts cleaners used at the site? Yes/No

If yes, list location(s) and solvent types: _____

I. Are there any drum and/or chemical storage areas?

If yes, list location(s) and materials: _____

J. Are cleaning products used routinely? Yes/No

If yes, When & Where: _____

K. Has painting/staining been done in the last 6 months? Yes/No

If yes, When & Where: _____

L. Is there new carpet, drapes or other textiles within installed within the last year? Yes/No

If yes, Where & When: _____

M. Are there air fresheners in office spaces or bathrooms? Yes/No

If yes, Where & Type: _____

N. Are there exhaust fans (e.g., break rooms, bathrooms, other locations)? Yes/No

If yes, where vented and how often do they run: _____

O. Has there been a pesticide application on the grounds? Yes/No

If yes, When & Type: _____

P. Is smoking allowed on the property? Yes/No

If yes, is it allowed within buildings and where? _____

Q. Are there odors in the building? Yes/No

If yes, please describe: _____

R. Are solvents used within the building? Yes/No

(e.g., chemical manufacturing or laboratory, auto mechanic or auto body shop, painting, fuel oil delivery, boiler mechanic, pesticide application, etc.)

If yes, what types of solvents are used: _____

Section IV – Occupancy/General Use

Location Use	Occupied (list hours/shifts)	Number of Employees (Full/Part-time)	Approx. Sq. Ft.	Level (basement, 1 st Floor, 2 nd Floor, etc.)	Brief Summary of Business/ Operations in Area (include additional sheets as necessary)
Office					
Manufacturing/ Production					
Warehouse/ Storage					
Garage					
Maintenance					
Conference/ Break Rooms					

Comments:

Section V – Site Layout

A. Building(s)

Draw a plan view sketch of each floor of the building. Indicate all pertinent information (including but not limited to: manufacturing areas, office areas, garage/maintenance areas, HVAC equipment, chemical storage areas, crawl spaces, locations of cracks with length, width and depth, location of settlement areas, floor penetrations, etc. Also include numbered locations of landfill gas readings and PID readings and place readings in table)

Comments:

B. Property Layout

Draw a sketch of the parcel including building(s), parking areas, exterior storage areas, ASTs, USTs, utility services (location entering buildings), monitoring wells, etc. Include compass direction and general topography.

Comments:

Basement:

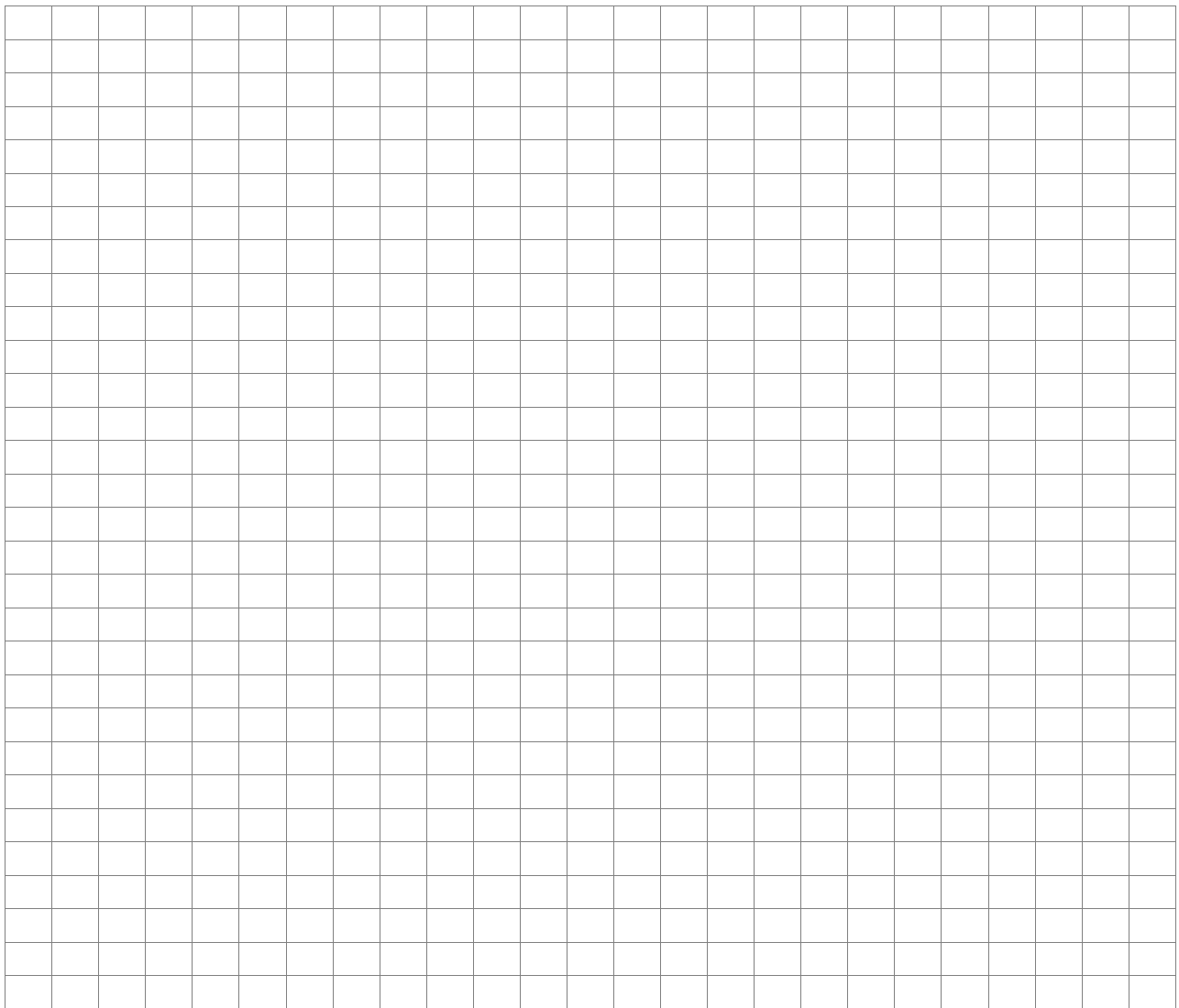
A large grid for drawing a basement sketch. The grid consists of 20 columns and 20 rows of small squares, providing a space for a detailed drawing of the basement layout.

First Floor:

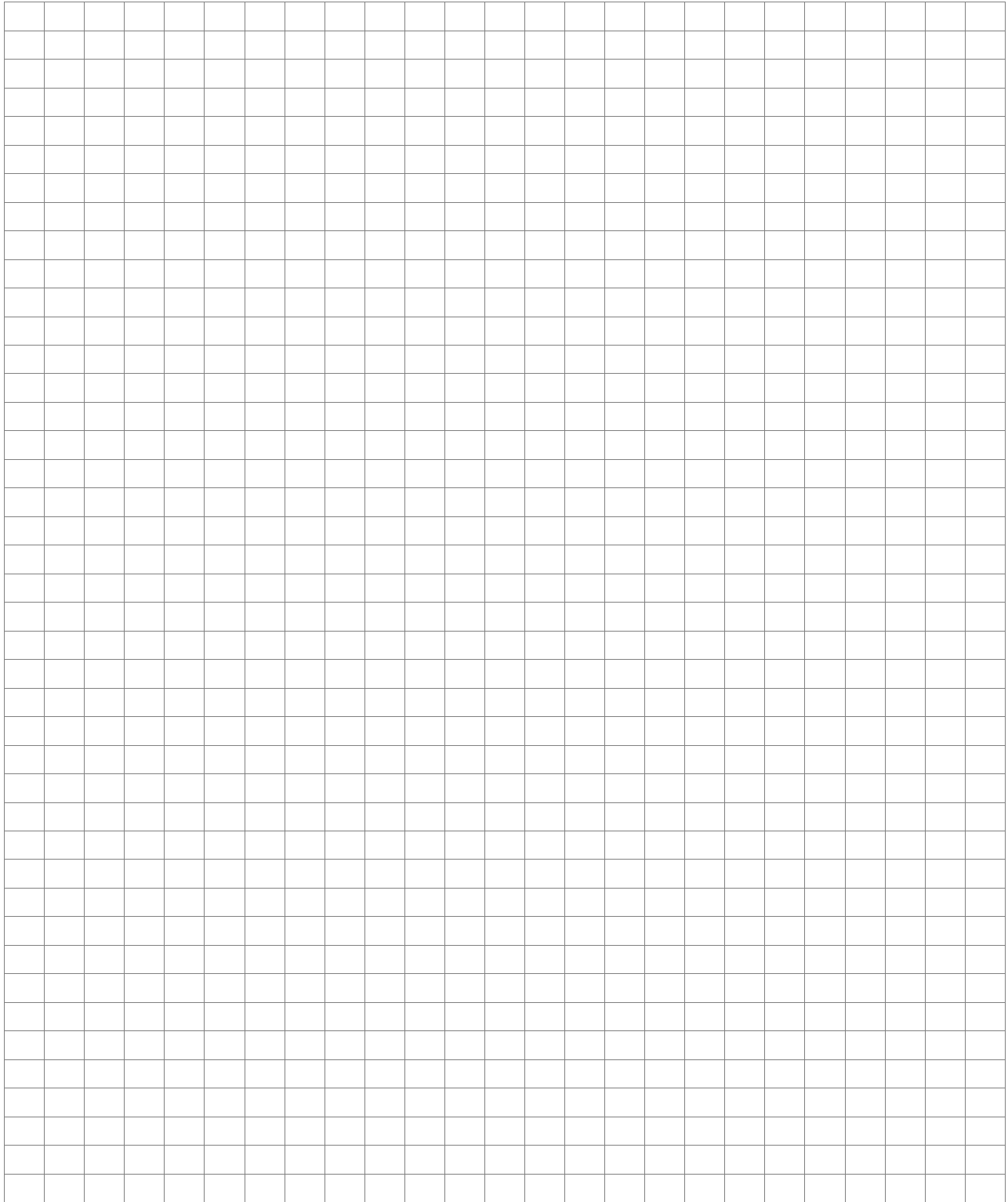

Property Layout:

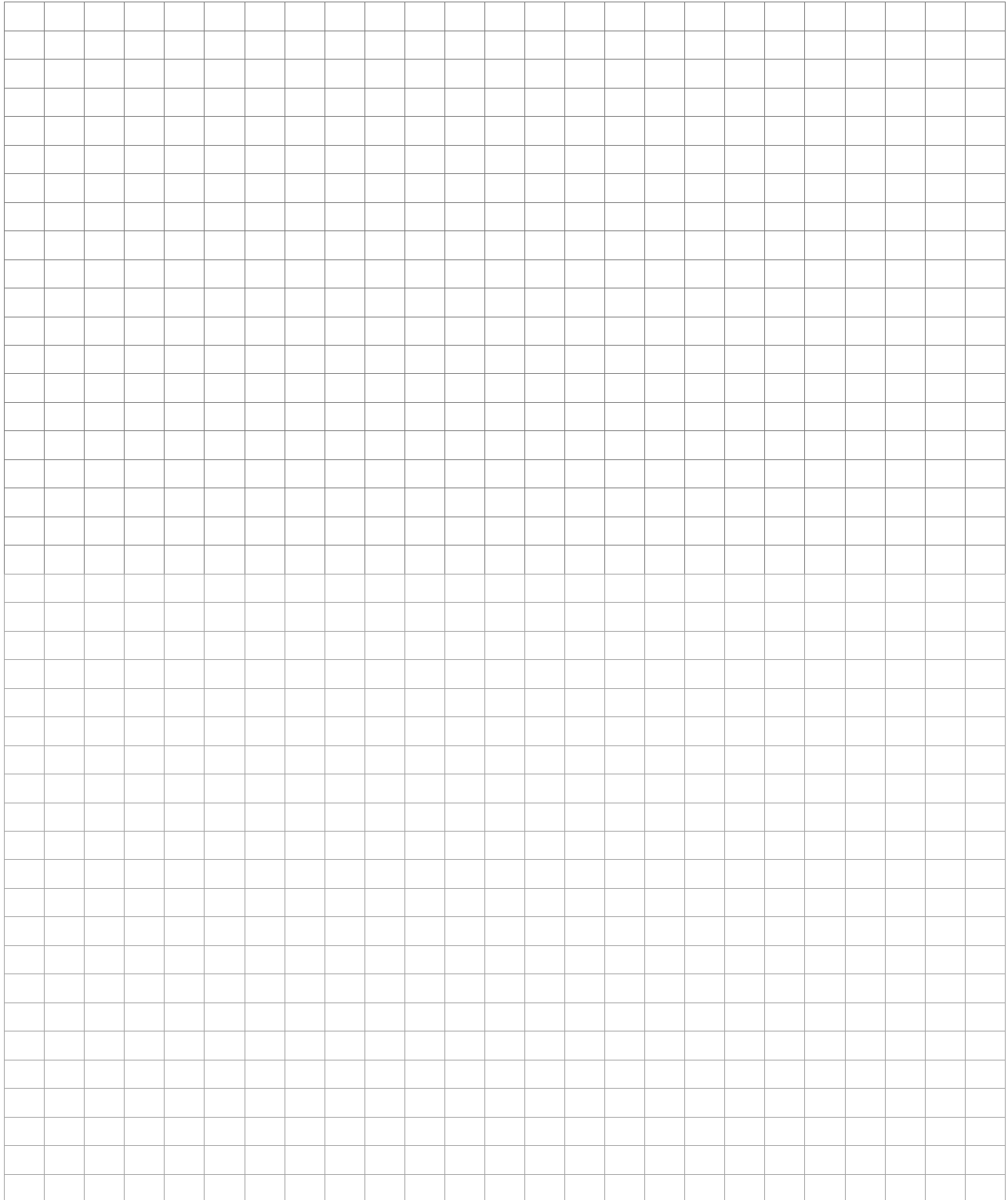

To be filled out by consultant:

Weather at time of site reconnaissance

Temperature: _____

Barometric Pressure: _____

Humidity: _____

Landfill Gas Meter

Type: LandTec GEM 2000 plus (or equivalent – **if approved by LaBella**) _____

Gases available (min. required: CH₄, CO₂, CO, H₂S, and O₂): _____

Calibration Notes*: _____

Photo-Ionization Detector

Type (min detection required 1 ppb): _____

Calibration Notes*: _____

*For instrument calibrations include at a minimum the date, method, gases, and % error and routine calibration sheets/logs and the most recent manufacturer/supplier service sheet. If the instrument is a rental unit include these items from vendor.

Document all readings on attached log.

Instrument Readings:

Mark each location on site sketch where reading was collected and provide a photograph. At a minimum, readings must be collected from all potential soil gas entry points within buildings (e.g., utility vaults, sumps, floor drains, oil/water separators, floor cracks, etc.) and any subsurface features on the exterior (e.g., catch basins, manholes, utility vaults, etc.). In addition, at least one breathing zone location will be measured for each discrete area within buildings.

Location	VOCs	CH4	CO2	H2S	CO	O2	Description & Comments
Units	ppb	%	%	ppm	ppm	%	
1							
2							
3							
4							
5							
6							
7							
8							
9							
10							
11							
12							
13							
14							
15							
16							
17							
18							
19							
20							