

# South Avenue & Elmwood Avenue Reconstruction Project

July 15, 2021

## Public Information Meeting (Zoom)

City of Rochester  
Department of  
Environmental  
Services

City Hall Room 300B  
30 Church Street  
Rochester, NY



City of Rochester, NY  
*Lovely A. Warren, Mayor*  
*Rochester City Council*



ERDMAN  
ANTHONY 



HIGHLAND PLANNING

## Format of this Meeting

- We'd like to take attendance. Please use the "chat" feature to provide your name and address.
- Meeting participants will be muted during the presentation.
- Meeting participants will be able to use the "raise hand feature" at the end of the meeting to ask a question.
- Meeting participants on a phone can dial \*9 to "raise your hand" at the end of the meeting to ask a question.



# Tonight's Presentation



City of Rochester, NY  
Lovely A. Warren, Mayor  
Rochester City Council

- Project Team
- Purpose of Meeting / Public Engagement
- General Project Overview
- Goals of the Project
- Bicycle Treatments
- Final Design Highlights (50% plans)
- Discussion / Next Steps
- Timeline
- Questions & Contacts



# Project Team



City of Rochester, NY  
Lovely A. Warren, Mayor  
Rochester City Council

**Mayor**  
**DES Commissioner**  
**City Engineer**

**Lovely A. Warren**  
**Norman H. Jones**  
**Holly E. Barrett, P.E.**



Street Design Manager  
Street Design Project Manager

Dominic Fekete, P.E.  
Tim Hubbard

MCDOT Project Liaison

Thomas Polech, P.E.  
Henry Herdzik, P.E.

Design Consultant

Erdman Anthony  
Lu Engineers  
EDR  
Highland Planning

# Purpose of Meeting



City of Rochester, NY  
Lovely A. Warren, Mayor  
Rochester City Council

## South Avenue & Elmwood Avenue Reconstruction Project

- Provide overview of the entire project
- Discuss progress on the project since our last meeting



## Meetings held to date:

- October 20, 2020 Public Information Meeting #1
- February 8, 2021 NBN6 Meeting
- February 25, 2021 Stakeholder Meeting
- July 15, 2021 Public Information Meeting #2



# General Project Overview



City of Rochester, NY  
Lovely A. Warren, Mayor  
Rochester City Council

## Project Location

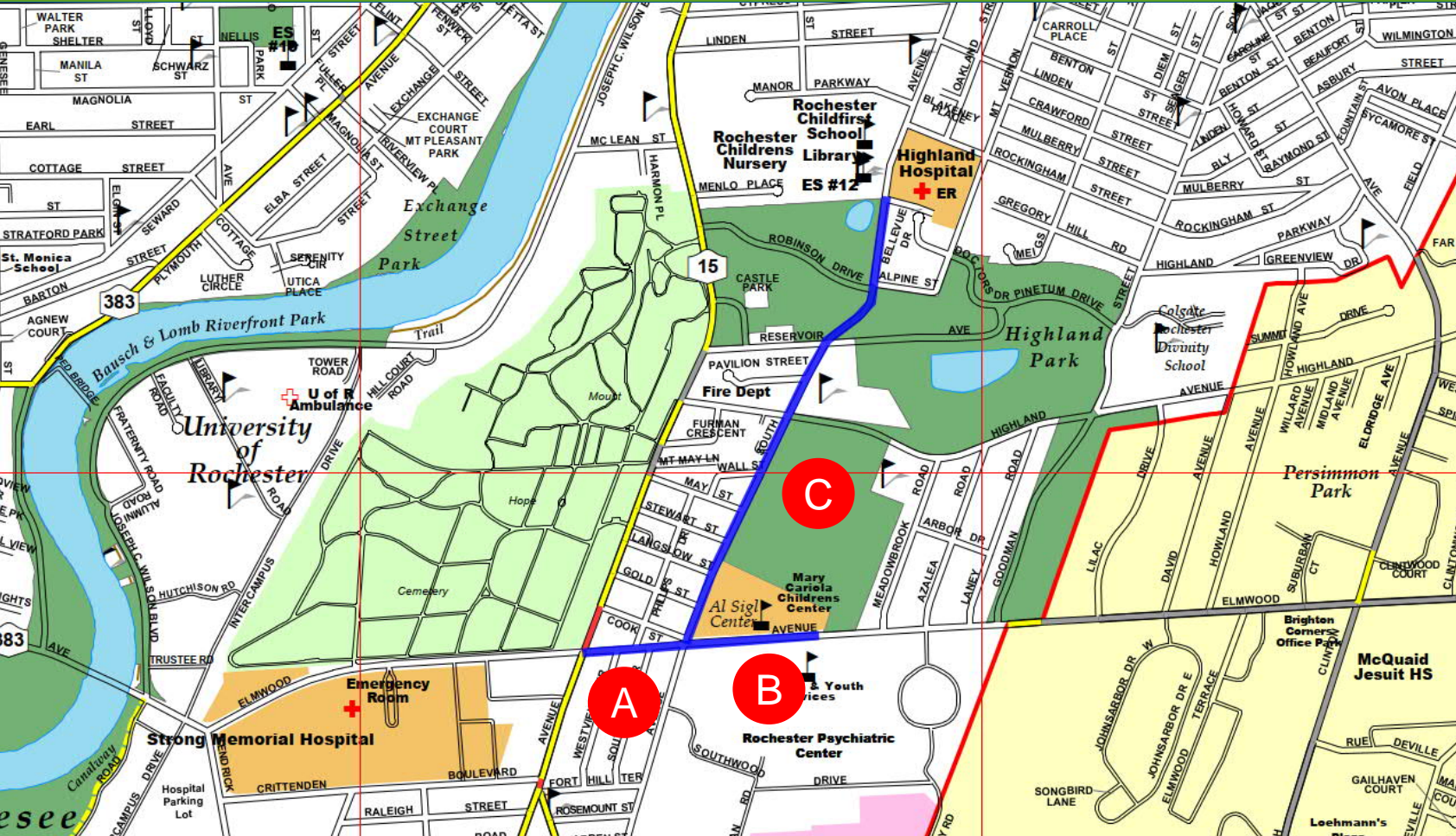

PC 16102

### South Avenue & Elmwood Avenue 131-K Arterial Reconstruction Project

Monroe County  
City of Rochester

Elmwood Avenue (0.17 miles)

Mt Hope Avenue to South Avenue  
South Avenue to Roch. Psych. Drive

South Avenue (0.88 miles)

Elmwood Avenue to Bellevue Drive

A

B

C

# Goals of the project



City of Rochester, NY  
Lovely A. Warren, Mayor  
Rochester City Council

Improve the  
street  
infrastructure

Meet minimum  
design  
standards

Maintain existing  
parking along  
the corridor

Maintain existing  
trees along the  
corridor

Provide  
pedestrian and  
bike facilities

Improve the  
condition of  
traffic control  
devices



# Recap of Project Design – Bicycle Treatments



City of Rochester, NY  
 Lovely A. Warren, Mayor  
 Rochester City Council

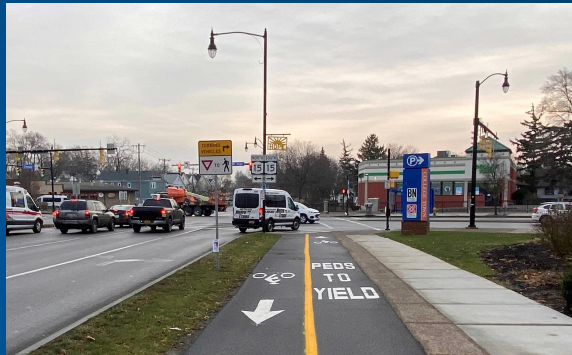
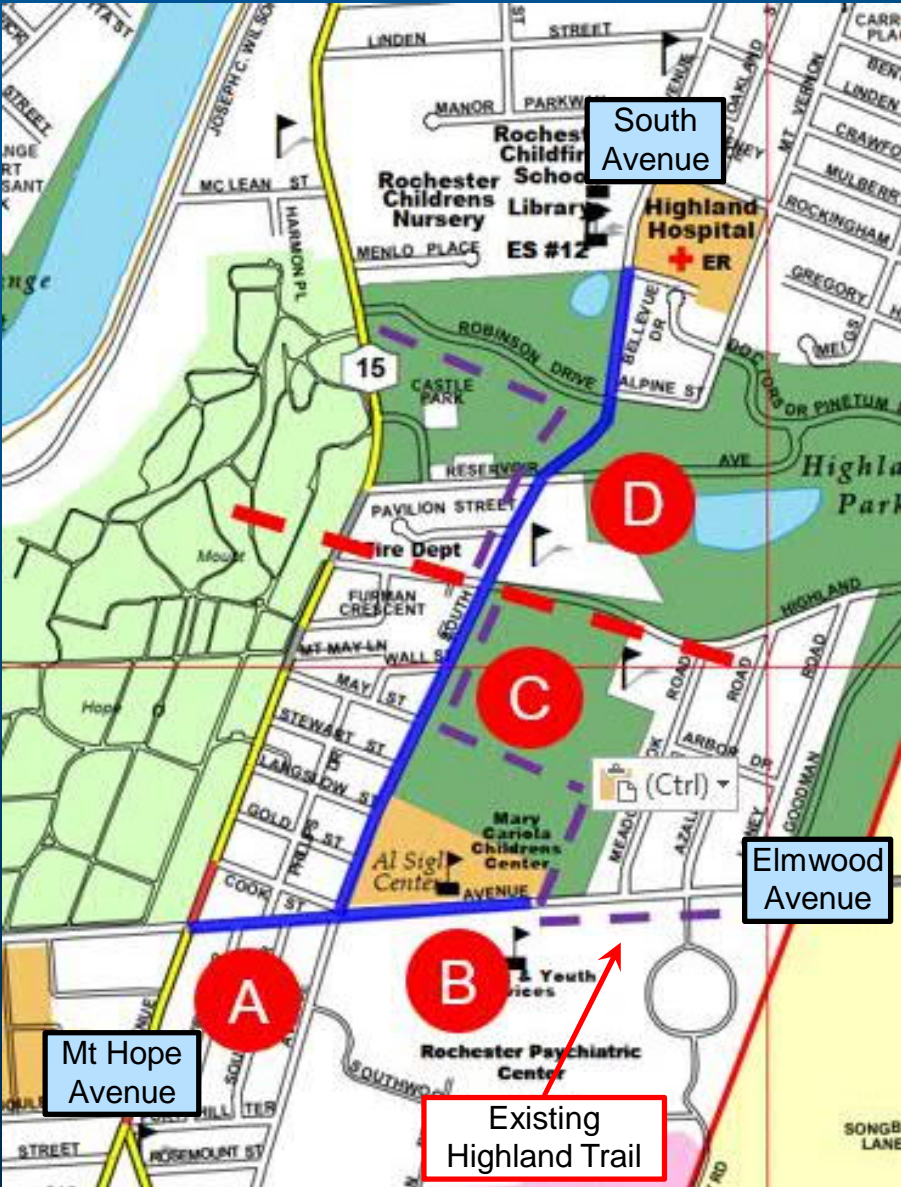

**A** Two-Way Cycle Track  
 (Mt Hope Avenue to South Avenue)



**B** Multi-Use Trail  
 (South Avenue to existing trail)

**C**

**C** In Street Bicycle Lane  
 (Elmwood Avenue to Highland Avenue)

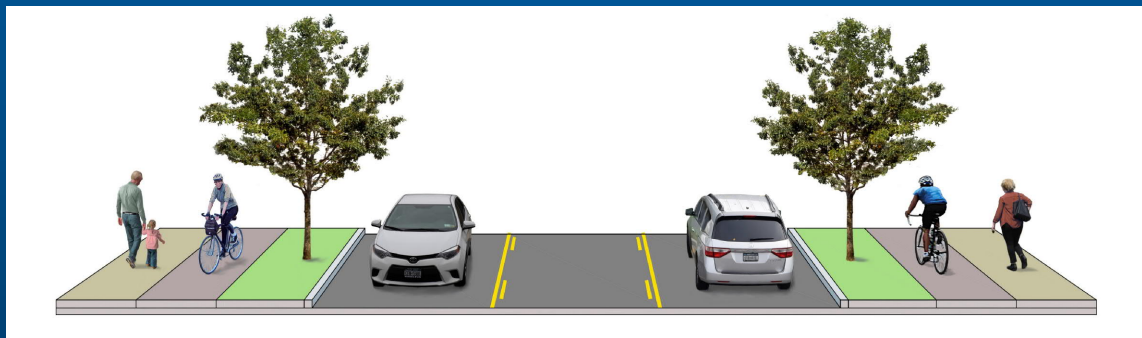
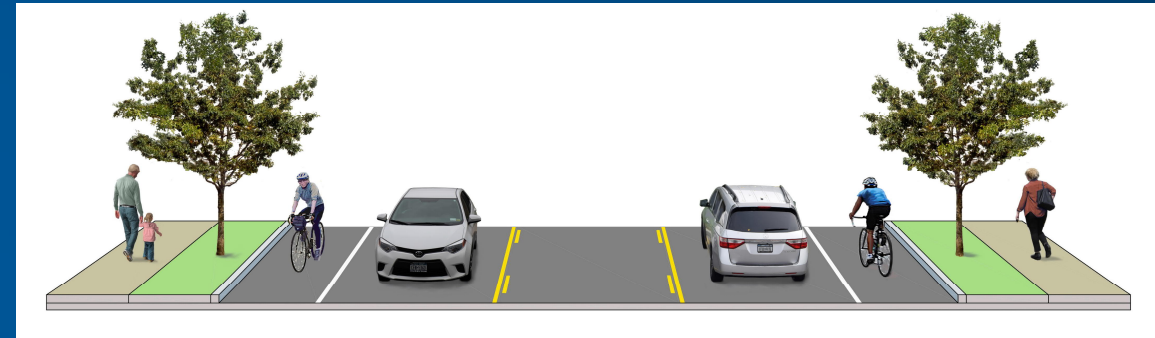

**D** One-Way Cycle Track  
 (Highland Avenue to Bellevue Drive)

# 50% plan highlight – Work Zone Traffic Control



City of Rochester, NY  
Lovely A. Warren, Mayor  
Rochester City Council



How will the project be constructed?

# 50% plan highlight – Elmwood Avenue Cycle Track



City of Rochester, NY  
Lovely A. Warren, Mayor  
Rochester City Council

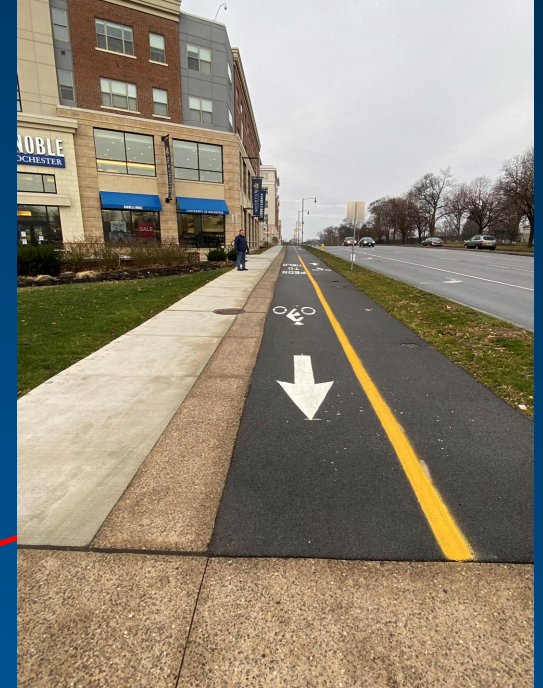
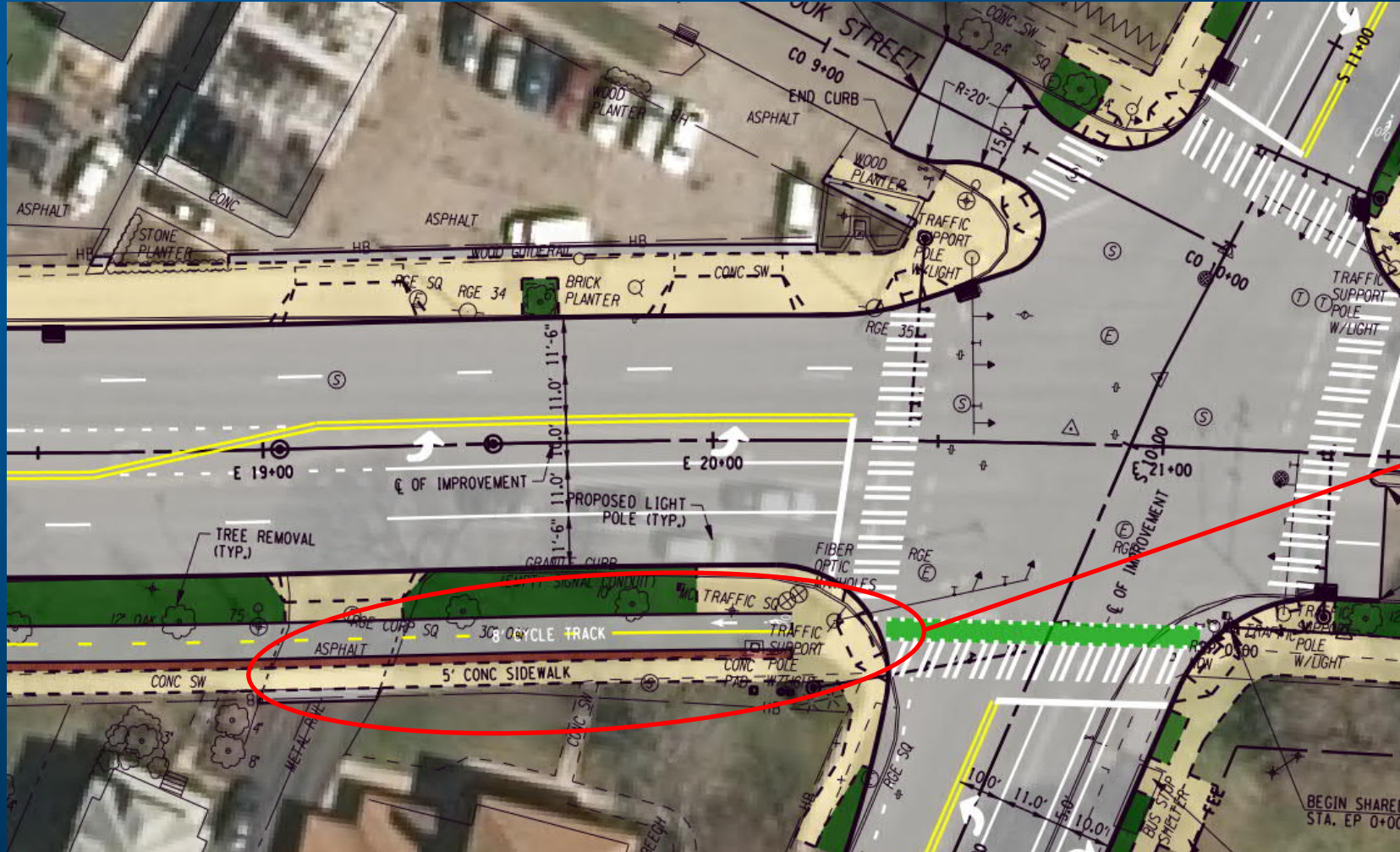

Example:  
Elmwood Avenue Cycle Track

# 50% plan highlight – South Avenue Cycle Track



City of Rochester, NY  
Lovely A. Warren, Mayor  
Rochester City Council

## Highland to Bellevue

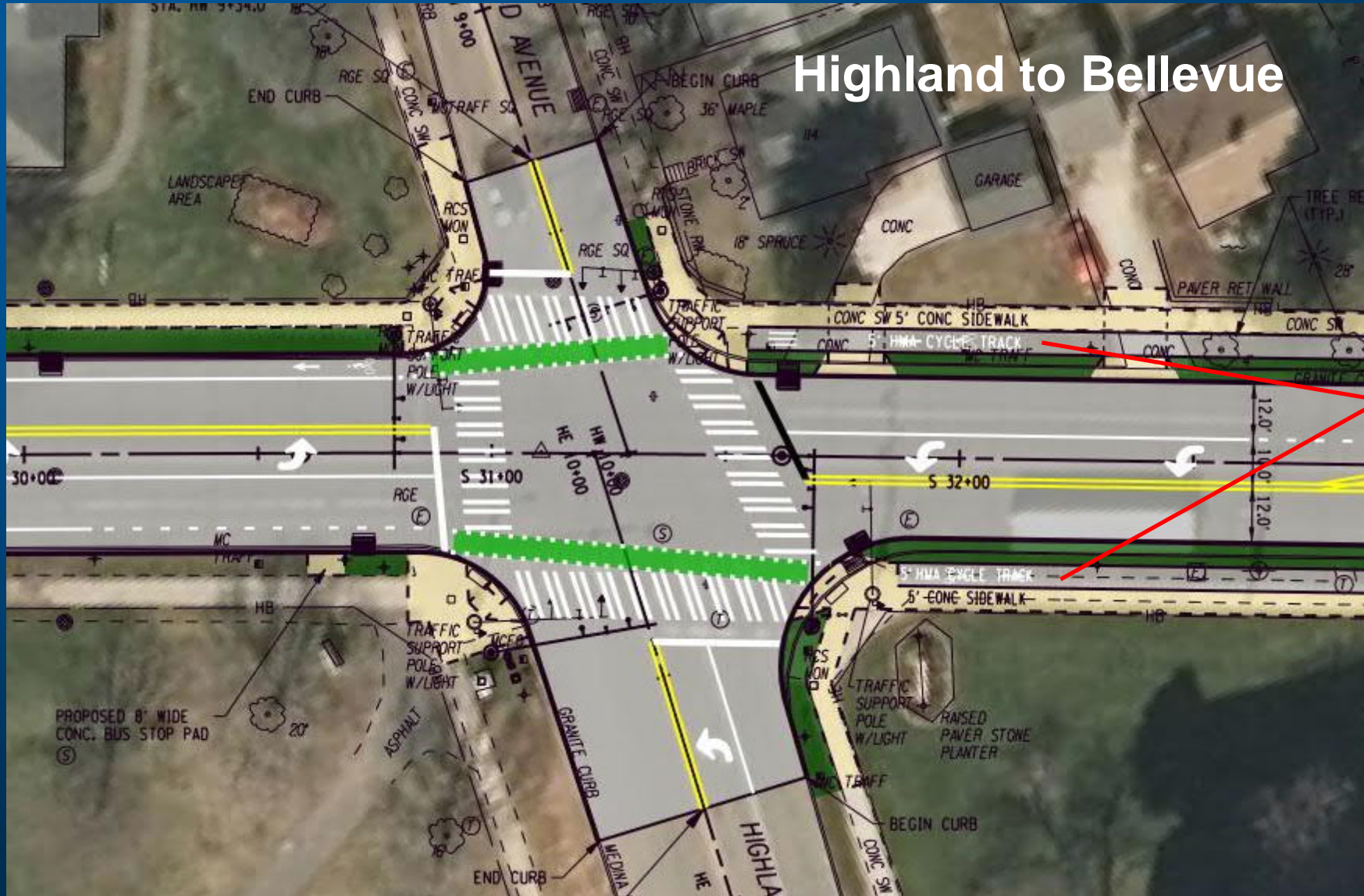

Example:  
Lake Avenue Cycle Track

# 50% plan highlight – Langslow Street Bump-Out



City of Rochester, NY  
Lovely A. Warren, Mayor  
Rochester City Council

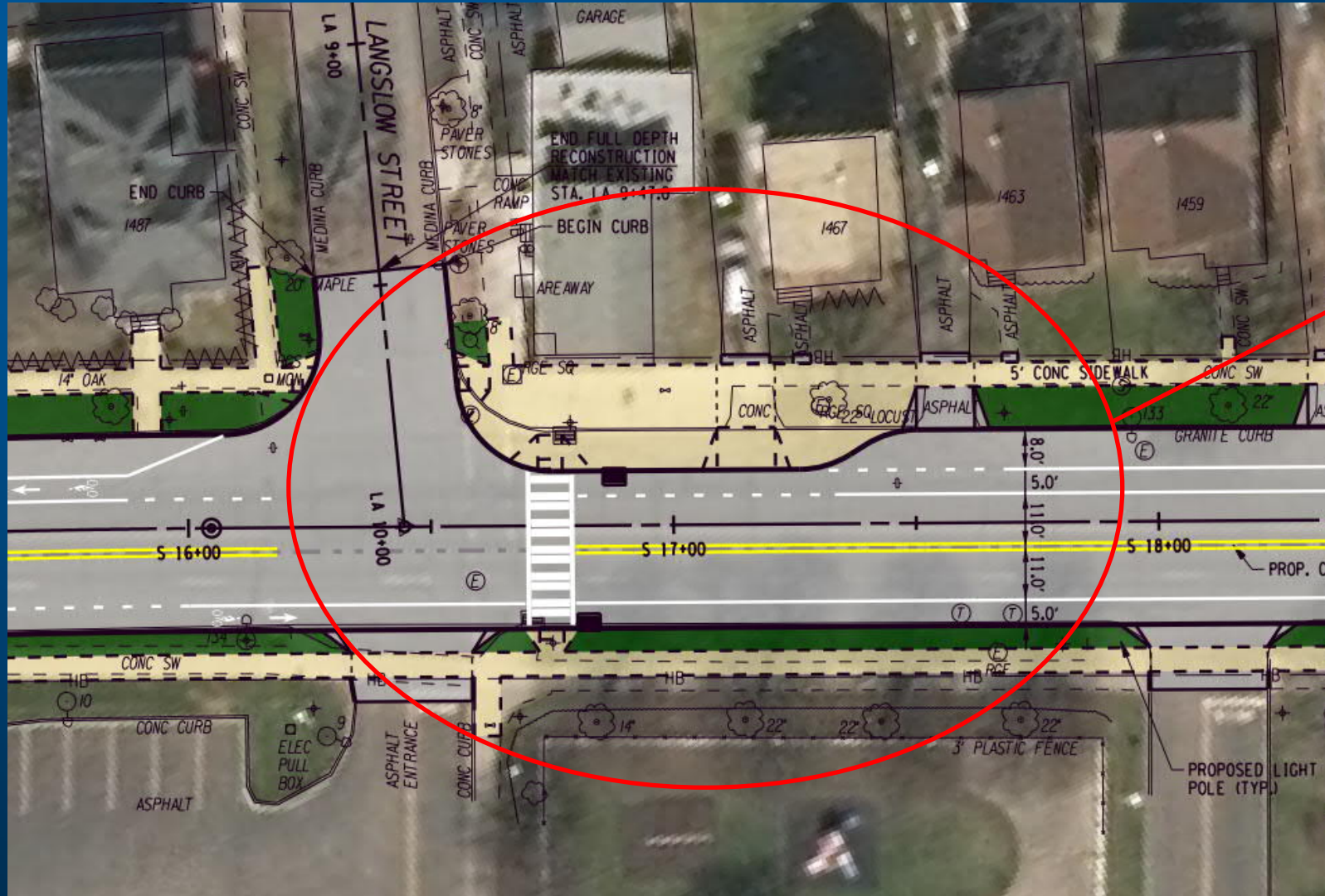

Example:  
Thurston Road

# 50% plan highlight – Reservoir Avenue RRFB



City of Rochester, NY  
Lovely A. Warren, Mayor  
Rochester City Council

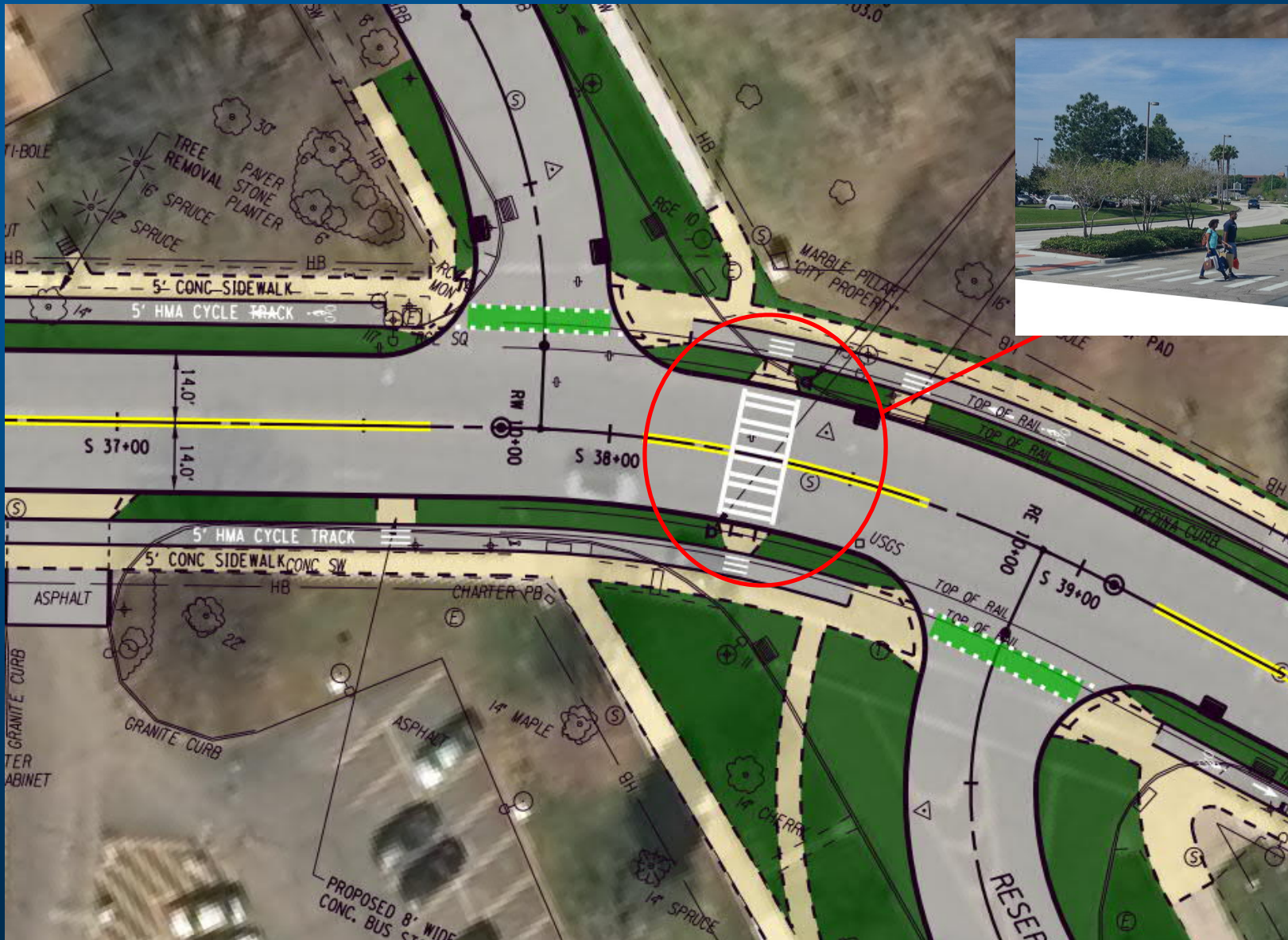

## Rectangular Rapid Flashing Beacons (RRFBs)

Increase visibility and improve driver yield rates at crosswalks with high-intensity flashing LED light bars.

# 50% plan highlight – Corridor Street Lights



City of Rochester, NY  
Lovely A. Warren, Mayor  
Rochester City Council

## New Light Poles

- LED light fixtures
- Provide uniform look
- Stand alone light poles
- Mounted on Traffic signal poles and Utility poles

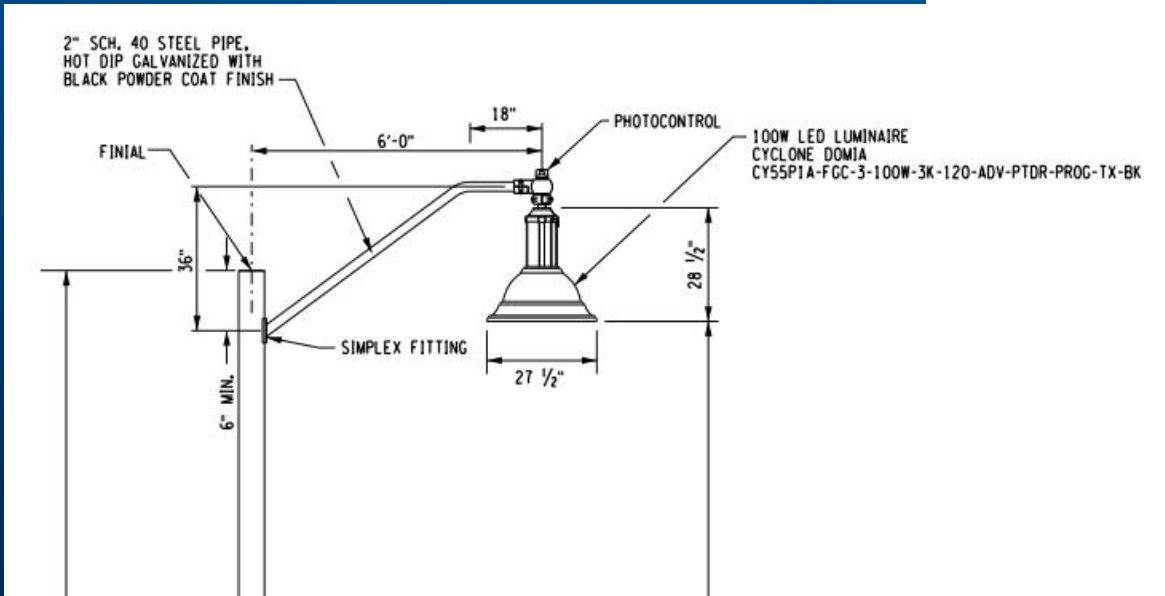
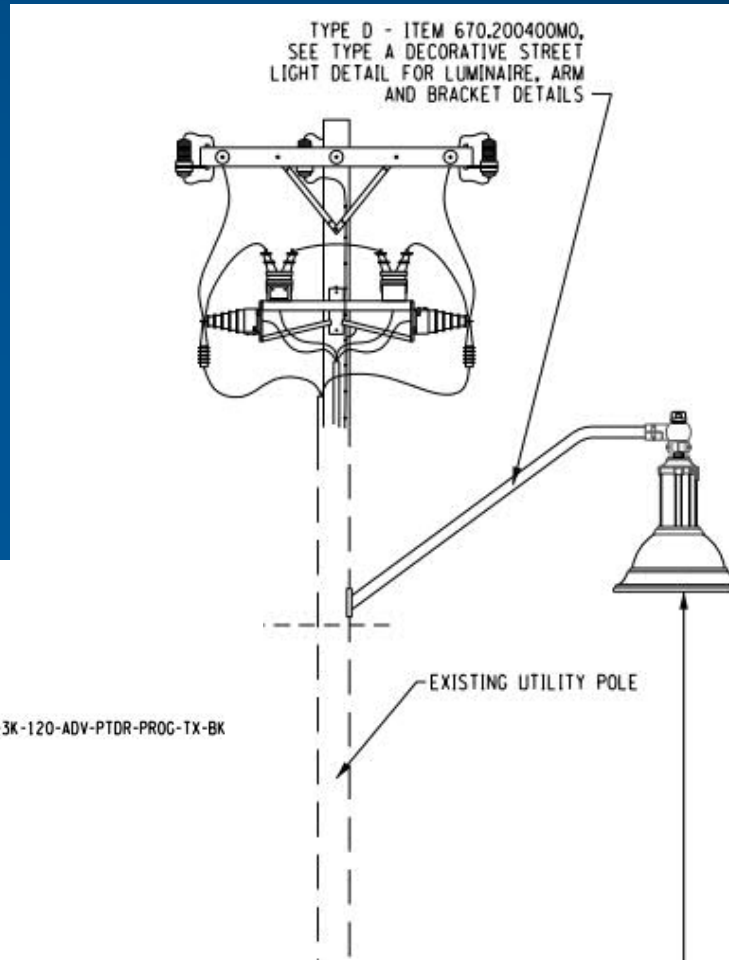

# Next steps for plan submission



The level of plan detail increases with each submission



# Project Timeline



City of Rochester, NY  
Lovely A. Warren, Mayor  
Rochester City Council

**August  
2019**  
Kick Off

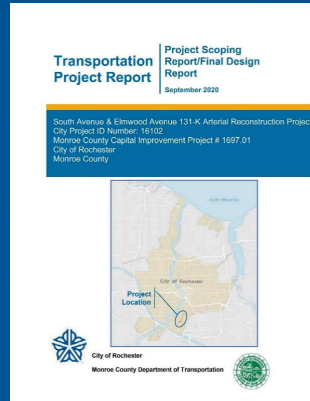

**Fall  
2021**  
Detailed Design Complete



**2022  
Construction Season**  
Construction Starts

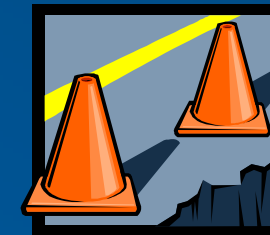

**Winter  
2021**  
Preliminary Design Complete  
/ Design Approval



**Fall  
2021**  
Bidding Starts

**2023  
Construction Season**  
Construction Complete

# South Avenue & Elmwood Avenue Reconstruction Project

**More Info**

July 15, 2021

<https://www.cityofrochester.gov/SouthAndElmwood/>



**City of Rochester, NY**  
*Lovely A. Warren, Mayor*  
*Rochester City Council*



**ERDMAN**  
ANTHONY 

 **HIGHLAND** PLANNING

**City of Rochester**  
**Department of**  
**Environmental**  
**Services**

**City Hall Room 300B**  
**30 Church Street**  
**Rochester, NY**