

FINAL DRAFT

City of Rochester Marina Harbor Wave Analysis



July 2009

Table of Contents

[page numbers to be updated/ revised in Final Report]

Table of Contents	2
I. Purpose	3
II. Executive Summary	4
III. Wave Summary	5
IV. Marina Entrance Recommendations	7
V. Actual Wave Observations	9
A. Actual Wind and Wave Observations	10
B. Shumway Video Photos	12
VI. Entrance Design Options.....	14
“Design and Construction of an Experimental Floating Breakwater System” i	

I. Purpose

The purpose of this report is to:

- A. Identify design waves for reasonable storm occurrences to identify probable conditions at the proposed marina entrance,
- B. Identify alternative entrance design options to reduce waves inside the marina basin during storms, and
- C. Make recommendations on alternative entrance designs, including recommendations for marina dockage based upon design wave and entrance configuration data.

II. Executive Summary

The following is a summary of the wave study:

A. Probable Occurrence of Waves

There is a probable annual occurrence of 2' to 4' waves reaching the entrance to the proposed marina near the boat launch. This surge could occur two to four times per year for 12 to 36 hours during a strong, northeasterly storm. It is expected that during the boating season, however, this occurrence would be once a year (or less), with the others occurring during the winter storm period. The navigation season is defined as May 1 through September 30.

Extreme wave conditions, however, could be anticipated to be 4' to 7' in height, which could potentially occur once every 50 or 100 years, again during an extreme, strong northeasterly period. This occurrence is likely in the middle of the winter and unlikely during the boating season.

B. Waves Within the Marina

Based upon our recommended entrance design, we would anticipate that the annual large waves generated at the marina entrance would result in an internal wave of 6" to 12" in the basin. Under extreme conditions, the large waves could result in a 12" to 18" wave/surge height within the marina basin. These internal waves assume a stone revetment is built throughout the entire marina basin. If vertical walls are used, then amplification would occur, resulting in waves being two to three times these projected heights. Therefore, vertical walls are not recommended (unless a lock gate is installed).

C. Wave Data

The data identified for these waves have been obtained from USACE and NOAA data sources and verified through actual observations by the study team, in addition to an observation video and photographs provided by Shumway Marine during a strong, northeasterly storm period.

D. Recommended Entrance Design

The recommended design is as shown on the following drawings and briefly described as follows:

- Marina master plan – Option 7, showing stone revetments inside the basin
- Keep the entrance width small, i.e., 60 feet, as shown on the plans
- Construct wave-dampening devices on the existing ferry terminal platform for both floating wave attenuators, up and downstream of the platform, in addition to wave baffle wall devices, up and downstream of the ferry terminal structure

It is noted that with the construction recommended above, wave conditions in this harbor will be better than those found in other marinas in the harbor, i.e., Rochester Yacht Club, Shumway Marine, etc. They will, however, potentially be greater than a marina's standard of 6" that we try to achieve for calm basins. However, based upon local conditions, we feel this will be acceptable and actually provide the best harbor relative to wave surge in Rochester given its proximity to Lake Ontario.

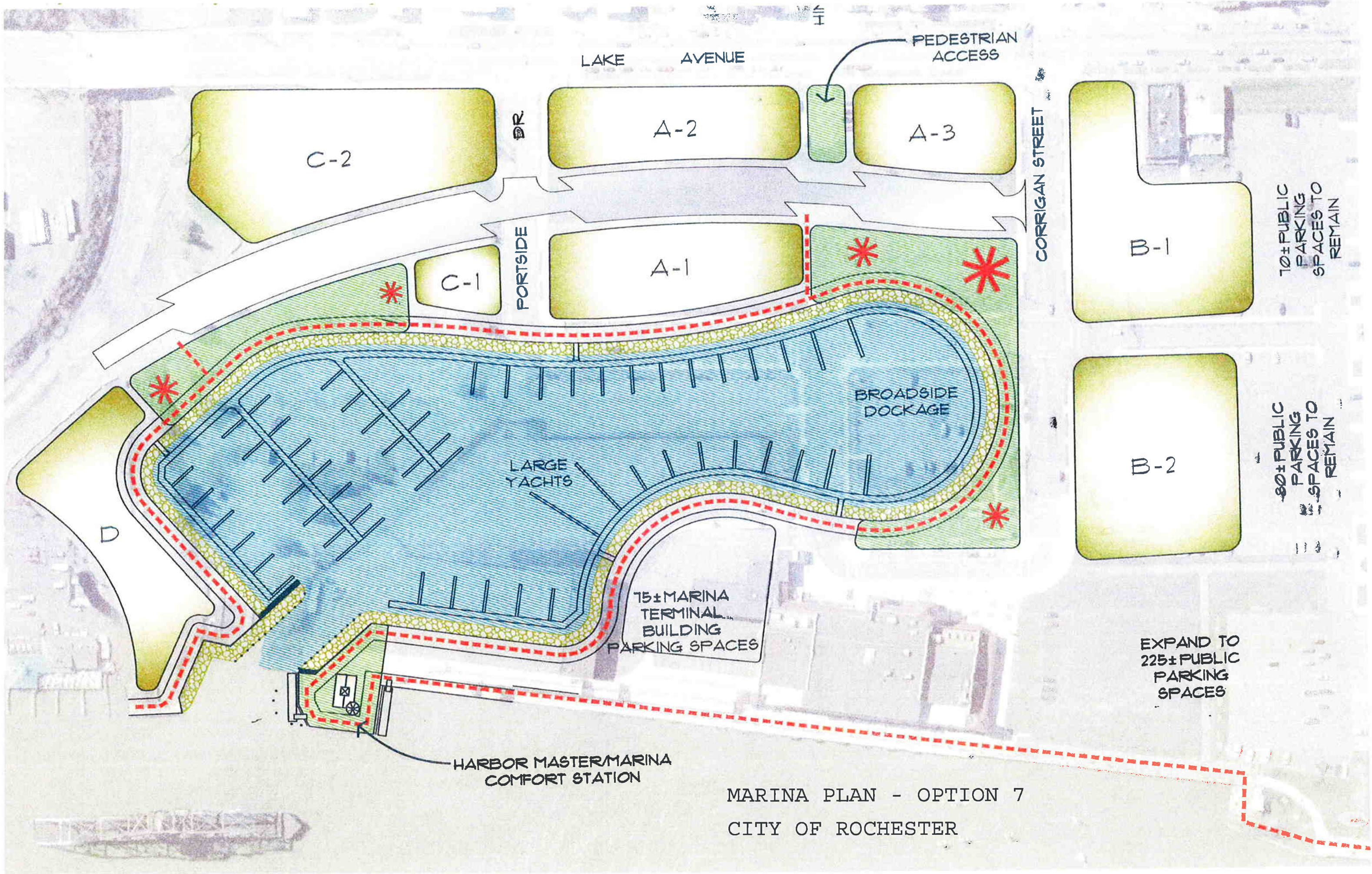

MARINA PLAN - OPTION 7
CITY OF ROCHESTER

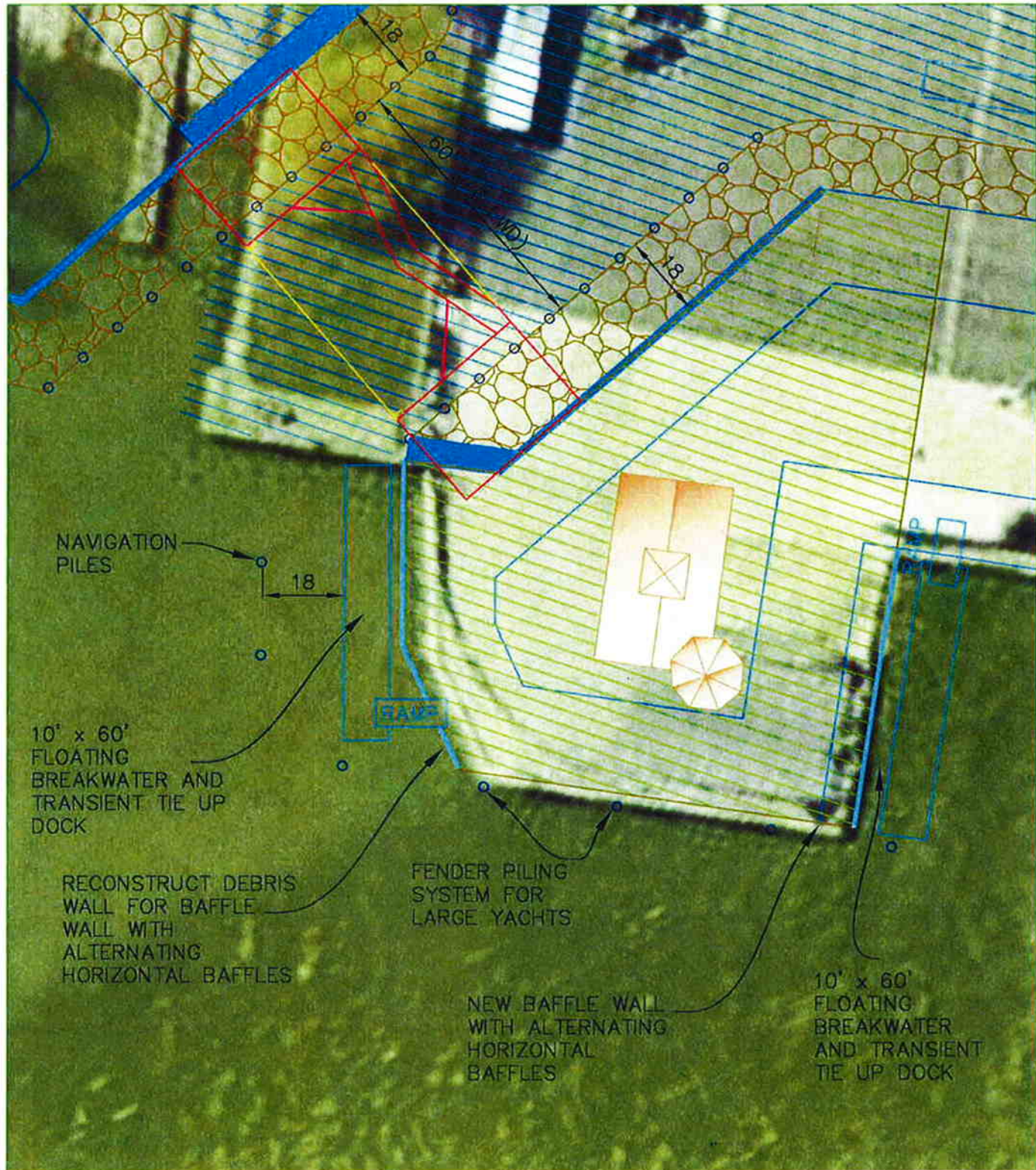



ABONMARCHE
Confidence By Design

ENGINEERING
ARCHITECTURE
MARINA/WATERFRONT
SURVEYING
LANDSCAPE ARCHITECTURE
PLANNING

95 West Main Street
P.O. Box 1088
Benton Harbor, MI 49923
T 268.927.2295
F 268.927.1017
www.abonmarche.com

MANISTEE, MI
SOUTH BEND, IN
FORT WAYNE, IN

PROJECT
**PORT OF ROCHESTER
MARINE IMPROVEMENTS PROJECT
PHASE I**

SHEET TITLE
DRAWN BY: **GMK**
DESIGNED BY: **RES**
FAM REVIEW:
QA/QC REVIEW:
DATE: **APRIL 2009**
SCALE:

SIGNATURE
DATE:

HARD COPY IS INTENDED TO BE
24" X 36" WHEN PLOTTED.
SCALES INDICATED AND
GRAPHIC QUALITY MAY NOT BE
ACCURATE FOR ANY OTHER SIZES.

SCALE
HORZ: 1/4"=1'-0"
VERT: N/A

ACI JOB #
M8-0270

SHEET NO

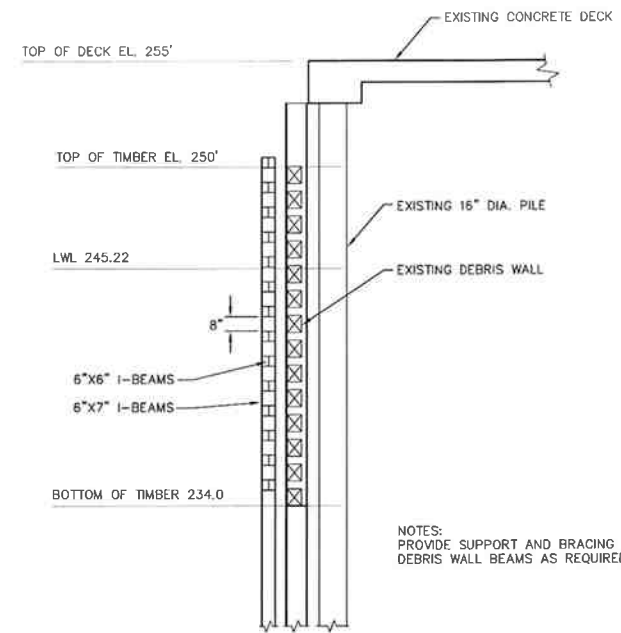

SECTION A-A
SOUTH SIDE RECONSTRUCTED DEBRIS/BAFFLE WALL
SCALE: 1/4" = 1'-0"

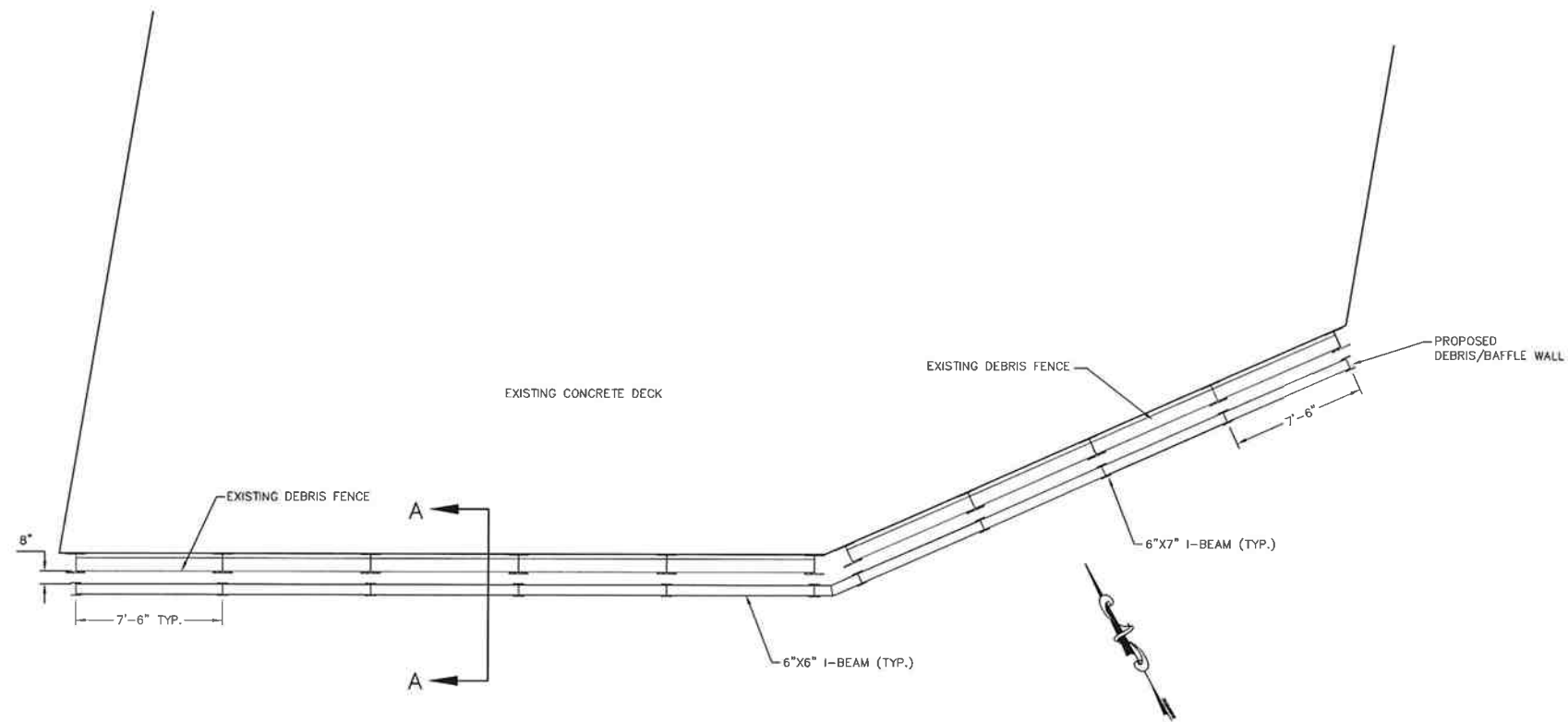

PLAN VIEW
SOUTH SIDE RECONSTRUCTED DEBRIS/BAFFLE WALL
SCALE: 1/4" = 1'-0"

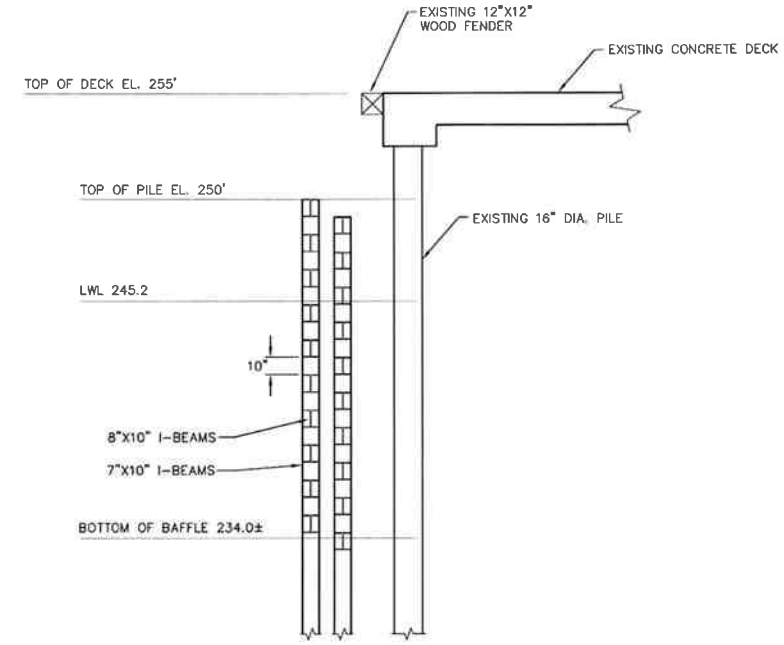

SECTION B-B
NORTH SIDE BAFFLE: WAVE ATTENUATOR
SCALE: 1/4" = 1'-0"

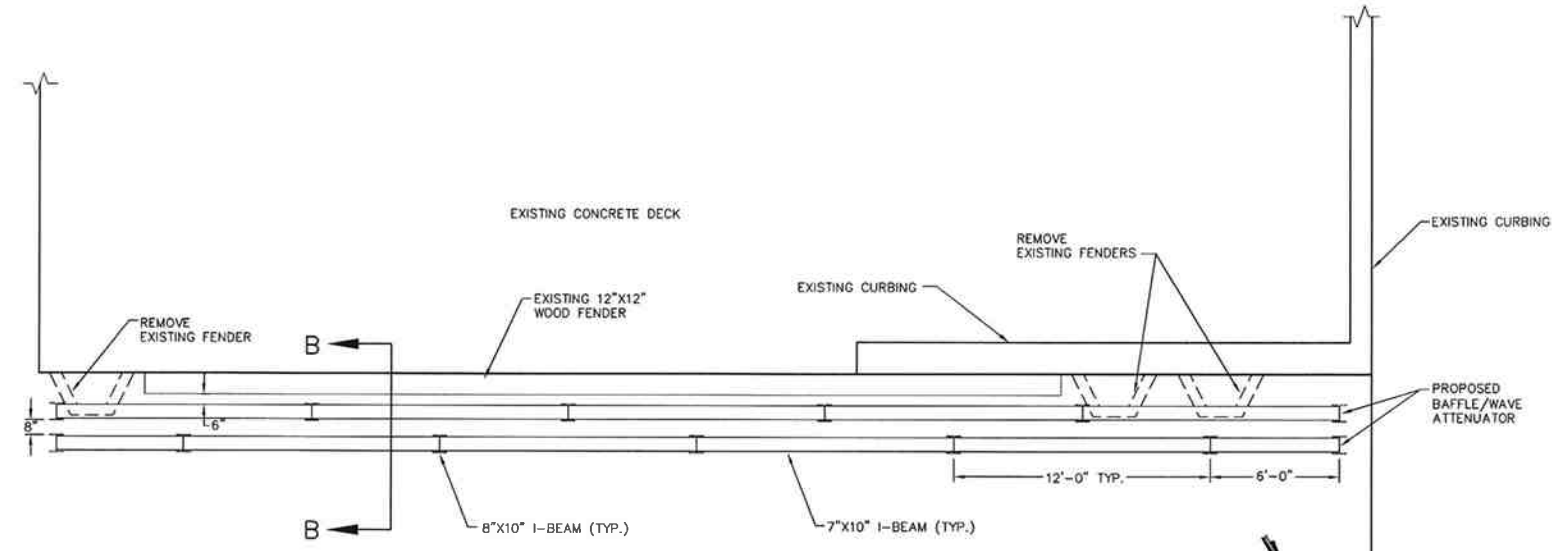

PLAN VIEW
NORTH SIDE BAFFLE: WAVE ATTENUATOR
SCALE: 1/4" = 1'-0"

NOTES:
PROVIDE SUPPORT AND BRACING TO EXISTING
16" DIA. PILES AND CONCRETE DECK AS REQUIRED.

NOTES:
PROVIDE SUPPORT AND BRACING TO EXISTING
16" DIA. PILES AND CONCRETE DECK AS REQUIRED.

NO.	REVISION DESCRIPTION	BY	DATE
-----	----------------------	----	------

© 2009 ABONMARCHE ENGINEERING ARCHITECTURE MARINA/WATERFRONT SURVEYING LANDSCAPE ARCHITECTURE PLANNING

III. Wave Summary

As part of the Abonmarche/Passero/Edgewater design team, United Design Associates (UDA) prepared a wave design and engineering analysis for the development of a marina at the 30-acre Port of Rochester site. The purpose of this Summary is to present the data, information, and conclusions in a clear, concise and meaningful understandable manner. The Study includes a Probability of Occurrence with a percentage of various wave heights based on the wave data submitted using the Rayleigh Distribution System and as submitted in the report for the worst wave Azimuth of 22° 30' with a fetch of 247,250' to the Proposed Boat Entrance. That this estimated summary during storms is as follows with the knowledge that no Probability system is perfect:

01% of the highest waves could be expected to be 9 feet

10% of the highest waves could be expected to be 7 feet

33% of the highest waves could be expected to be 4.5 feet

100% of the highest waves could be expected to be 3.4 feet

2. The Corresponding wave analysis is verified from a practical point of view by visual observation of a video during what appears to be an average storm. In addition, these wave intensities could be reduced by additional rock riprap along the rivers edge, and along the harbor basin. However, when the waves become nearly parallel, they may not reflect and form gradually swelling crests running along the edge as witnessed in the video. Placement of properly designed baffle wave attenuator structures similar to (but more expensive than) the existing debris fence at Port Harbor Ferry location will reduce wave energies approaching the marina entrance. Wave attenuators placed upstream and downstream of the ferry terminal platform and within the boat basin (along with floating piers that have a built-in baffle system) will reduce wave activity. It has been UDA's experience that unless the attenuators are extensive and part of the pier system, they will not be effective in a wave climate such as exists in the Genesee River.

SYLLABUS

As part of the Abonmarche/Passero/Edgewater design team, United Design Associates (UDA) was asked to provide a wave study and engineering analysis for the development of a marina at the 30-acre Port of Rochester site. UDA's objective in conducting a wave study is to make a complete evaluation of the wave dynamics that will or could occur and to what extent a viable solution can be found for developing a successful and functional marina within the recommended limits of boat mooring wave activity. UDA's methodology is to research and acquire as much background information as they can including the latest WIS (wave information studies) conducted by the US Army Corps of Engineers for Lake Ontario and its relationship with Rochester's Genesee River.

BACKGROUND

Prior to UDA's investigation, they reviewed the following Reports:

1995 Rochester Harbor, New York Design for Wave Protection Coastal Model Investigation by Robert R. Bottin, jr., Hugh F. Acuff	1995 Wave Surge Project Rochester Harbor, New York U.S. Army Corps of Engineers Buffalo District
---	---

1993 Preliminary Reconnaissance Report
Rochester Harbor, New York
US Army Corps of Engineers
Buffalo District

The foregoing reports immediately brought UDA's attention to the primary (Wave Surge Problems) and the fact that the foregoing report information did not include a frequency of occurrence analysis to develop a relationship between wave height and damage. Therefore UDA's plan was to begin with the WIS Report 25 at Station O12 at 43.32°N 77.45°W that has a deep water wave data along with frequency of occurrence. With this information it might be possible to determine the frequency of occurrence and extent of damaging waves that could be reasonably determined.

WAVE FORECASTING:

Prior to 1991 the wind data needed to determine the wave intensity developed by wind speeds was primarily taken from the Historic Extreme Winds for the United States Great Lakes and adjacent regions published by the United States Climatic Center, Ashville, North Carolina, ie for Rochester New York:

Return Period (Years)	Wind Speed (mph)	Return Period (Years)	Wind Speed (mph)
01	42	20	73
02	56	25	74
05	63	50	79
10	68	100	83

However, the Coastal Engineering Research Center, Department of the Army, Waterways Experiment Station, Corps of Engineers in the interest of providing more accurate data and information based on actual measured data developed a study covering a 32 year period of data collection, released in 1991, to provide a comprehensive data base descriptive of the long term wave climate for the Great Lakes.

WAVE HEIGHT INFORMATION:

The Station Ontario 12 (O12) report describes the selection of a grid and hindcast sites, methods used to process and prepare input wind fields, numerical model calibration and verification, and production of a 32-year (1956-1987) hindcast. The Canadian Marine Environmental Data Service (MEDS) Wave-Rider Buoys 60 and 65 were used for calibration and verification on Lake Ontario. Although the duration of record is short, these MEDS data are the only continuous set of wave data on Lake Ontario. The winds were interpolated over the grid at 3-hr intervals. The results of various parameter file analysis, including calculation of percent occurrence tables, mean and maximum monthly values, and return period statistics, are presented for the designated wave Stations.

The wave model used in the WIS REPORT 25 Station O12, DWAVE was developed by Dr. Resio of Offshore and Coastal Technologies, Inc. The fetch-growth characteristics of DWAVE are similar to the Joint North Sea Wave Project (JONSWAP) relationship, i.e., wave energy increases linearly with fetch; and the duration-growth characteristics are roughly similar to those of Resio (1981) and the US Navy's Spectral Ocean Wave Model (SOWM). Most numerical wave models require a certain amount of fine-tuning, or calibration, when first applied to a particular area. To determine if, and to what degree, the model used in the present study required calibration, modeled wave parameters from the grid point closest to MEDS Buoys 64 and 74 were compared with available buoy-measured wave parameters. Time-series plots and percent distribution histograms of measured versus modeled wave height and peak spectral period were examined. Wind speed was not measured by the MEDS buoys, and therefore, it was not available for comparison purposes.

Wave height measurements on Lake Ontario are very scarce and all reliable data from MEDS Buoys 60 and 65 for the period April-November 1972 were compared with hindcast results from the same time and location using the distributions of height and period as a measure of acceptability. Excellent results were obtained at Buoy 65, whereas the model tends to over-predict the measured wave height at Buoy 60. The lack of measured wind information for comparison with modeled winds precluded the application of any direct improvements. It was therefore concluded that the model with adjusted winds could be used successfully to provide an accurate representation of wave climatology on Lake Ontario.

Although the published hindcast wave information did not include wind speeds, UDA using the Station wave frequency of occurrence wave heights with corresponding water depth and fetch distances, developed a numerical transformation model that is consistent with known wave data in the WIS Station, and the foregoing Reports listed above. This model, in the opinion of UDA, does provide a reasonably accurate wave transmission from the Deep Water Station O12 to the Genesee River Entrance as shown on Lake Survey Charts 14800 and 14815.

WAVE STUDY PROCEDURE:

This wave study procedure is being conducted in three parts to determine the following:

1. Critical Wave Characteristics at the Wave Information Station Ontario 12 (O12) at 43° 19' 12" N 77° 27' W.
2. Critical Wave Characteristics Transformed from Station O12 to the Genesee River Entrance to Lake Ontario at 43° 15' 49" N 77° 35' W.
3. Critical Wave Characteristics Transformed from the Genesee River Entrance to Lake Ontario to the Proposed Boat Harbor Entrance Area at ± 43° 15' 14" N 77° 36' 29" W.

PROBABILITY OF OCCURRENCE A RAYLEIGH DISTRIBUTION:

Subsequent to the following compilation of extensive wave data the Probability of Occurrence $p(H_i)$ of the worst wave Azimuth of $22^\circ 30'$ with a corresponding fetch of 247,250 feet up to the proposed Boat Entrance using the Rayleigh Distribution based on the compiled data.

The Probability of Occurrence $p(H_i) = \frac{2H_i}{(H_{rms})^2} e^{-(H_i/H_{rms})^2}$ CEM: II-8-4

RAYLEIGH

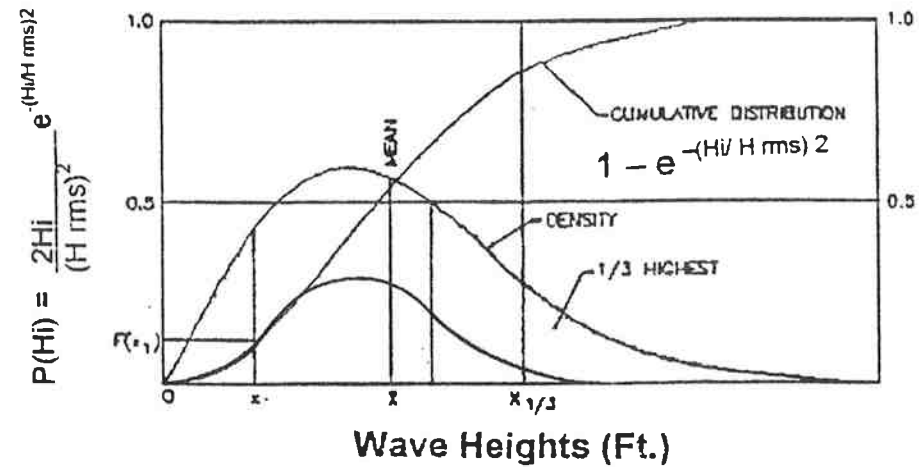

WAVE HEIGHT INFORMATION CONTINUED:

(N) Waves H_i	Waves H_i^2	$\frac{2H_i}{(H_{rms})^2}$	$e^{-(H_i/H_{rms})^2}$	$p(H_i)$	Cumulative Probability $1 - e^{-(H_i/H_{rms})^2}$	Wind Speed (FPS)
0.40	00.160	0.0378	0.9880	0.0373	0.0120	06.79
1.17	01.369	0.1106	0.9024	0.0998	0.0976	13.12
1.78	03.168	0.1682	0.7883	0.1326	0.2117	18.95
2.28	05.198	0.2155	0.6769	0.1459	0.3231	24.87
2.72	07.398	0.2571	0.5738	0.1475	0.4262	30.97
3.10	09.610	0.2930	0.4861	0.1424	0.5139	37.23
3.46	11.972	0.3270	0.4071	0.1331	0.5929	43.63
3.78	14.288	0.3573	0.3422	0.1223	0.6578	50.14
4.09	16.728	0.3866	0.2849	0.1101	0.7151	56.74
4.37	19.097	0.4130	0.2385	0.0985	0.7615	63.41
4.63	21.437	0.4376	0.2001	0.0876	0.7999	70.14
4.88	23.814	0.4612	0.1674	0.0772	0.8326	76.92
5.12	26.214	0.4839	0.1398	0.0676	0.8602	83.77
5.35	28.623	0.5057	0.1167	0.0590	0.8833	90.65
$\Sigma 50.33$	$\Sigma 199.316$			$\Sigma p(H_i)dx = 1.00$		
$N = 15$				$\Sigma = 1.601$		
Average 3.36				$\Sigma p(H_i)dx = 1.00$		

Area under the curve: $1.601(dx) = 1.601(0.6246) = 1.00$

$H_{rms} = (1/N \Sigma H_i^2)^{0.5} = (1/15(199.316))^{1/2} = 3.65$

PROBABILITY OF OCCURRENCE A RAYLEIGH DISTRIBUTION CONTINUED:

The mean wave height $H_{100} = \int H_i p(H_i) dH_i = ((\pi)^{1/2} H_{rms}) / 2 = 3.23$

The cumulative probability distribution $P(H_i) = \int p(H_i) dH_i = 1 - e^{-(H_i/H_{rms})^2} = 1 - 0.1167 = 0.8833$

From the integration of $P(H_i) = \int p(H_i) dH_i = 1 - e^{-(H_i/H_{rms})^2}$ leads to the following:

Since $\frac{H_{100}}{H_{rms}} = \frac{3.23}{3.65} = 0.8848$ $H_{33} = 5.16$ and $H_{33}/H_{100} = 1.60$ and $H_{33}/H_{rms} = 1.41$,

$P(H_{33}) = 1 - e^{-(1.41)^2} = 0.8630$ and $1 - P(H_{33}) = 0.1370 = 13.7\%$ of the waves can be expected to exceed the significant wave height :

$H_n/H_{100} = 2.68$, $H_n = 2.68(3.23) = 8.65$

This leads to the following distribution of wave heights:

(n) % of Waves	$H_n/H_{33} = H_n/5.16$ (x) The significant Wave Height (Ft)	$H_n/H_{100} = H_n/3.23$ (x) The Average Wave Heights (Ft)
1	$H_n/5.16 = 8.65/5.16 = 1.68 \times 5.35 = 8.98$	$H_n/3.23 = 8.65/3.23 = 2.68 \times 3.36 = 9.00$
10	$6.59/5.16 = 1.28 \times 5.35 = 6.85$	$6.59/3.23 = 2.03 \times 3.36 = 6.82$
33	$5.15/5.16 = 1.00 \times 5.35 = 5.35$	$5.15/3.23 = 1.60 \times 3.36 = 5.38$
50	$4.58/5.16 = 0.89 \times 5.35 = 4.76$	$4.58/3.23 = 1.42 \times 3.35 = 4.76$
100	$3.24/5.16 = 0.63 \times 5.35 = 3.37$	$3.24/3.23 = 1.00 \times 3.35 = 3.35$

Statistically the characteristics of wind waves are most easily handled by evaluation of the probability distribution of wave heights and the determination of the mean wave heights H_{33} , H_n , H_{10} and so on has the following evaluation at the proposed river entrance to the proposed mooring basin.:

- 1% of the highest waves can be expected to be 9 feet
- 10% of the highest waves can be expected to be 7 feet
- 33% of the highest waves can be expected to be ± 5.5 feet
- 50% of the highest waves can be expected to be ± 4.8 feet
- 100% of the highest waves can be expected to be ± 3.4 feet

DEPTHS IN METERS

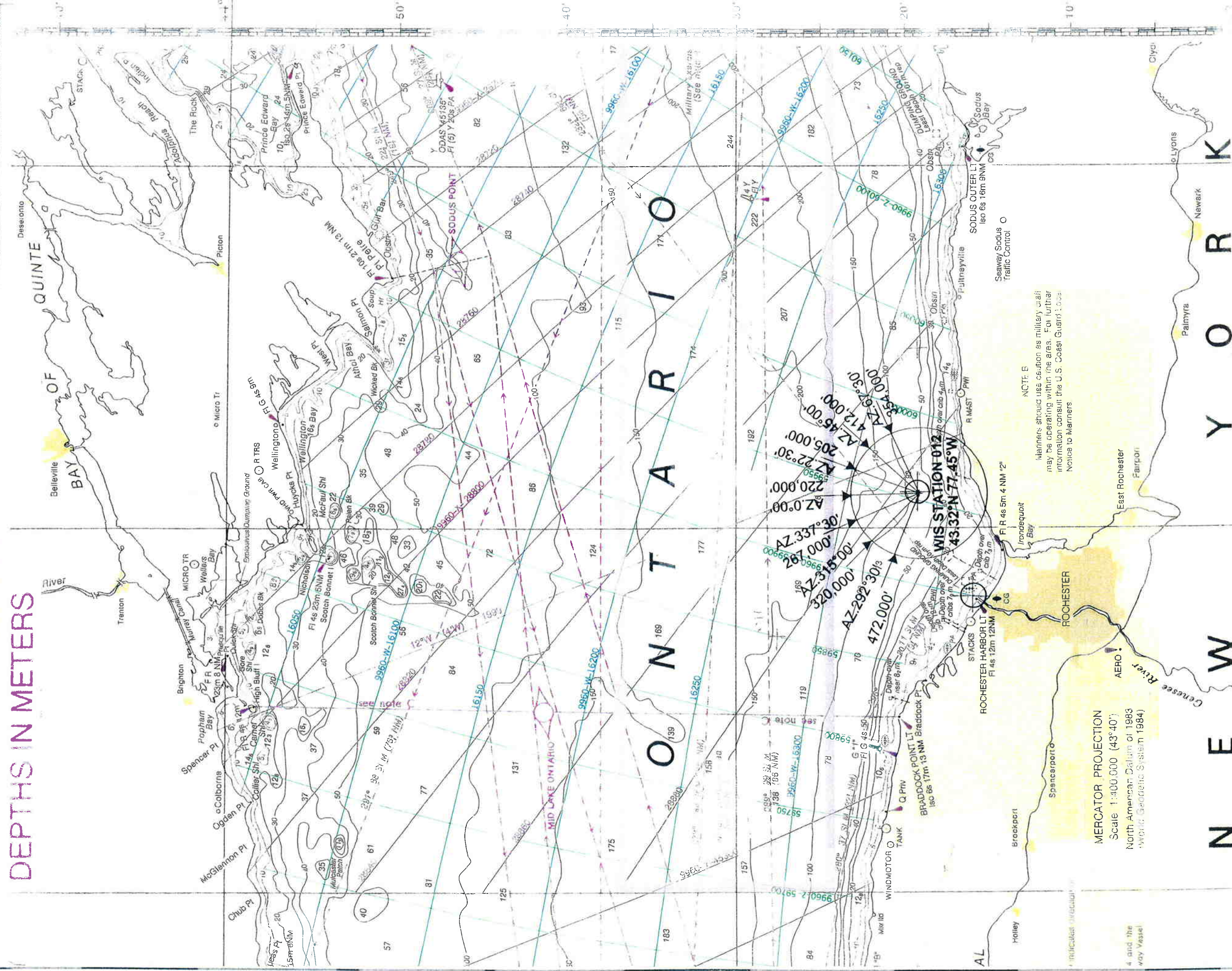

MERCATOR PROJECTION
Scale 1:400,000 (43°40')
North American Datum of 1983
World Geodetic System 1984

NOTICE: Mariners should use caution as military aircraft may be operating within the area. For further information consult the U.S. Coast Guard Notice to Mariners

14800

JOB NO:
SHEET NO:

uda
united design associates
111 NORTH MAIN STREET
CHEBOYGAN
MICHIGAN 49721
231-627-2288
231-627-3491
FAX 231-627-9377

SHEET TITLE:
CITY OF ROCHESTER NEW YORK WAVE STUDY
SCALE:

PRELIMINARY
CONSTRUCTION
FINAL RECORD

DRAWN:
DATE:
PRELIM:
ISSUED:
REVISIONS:

WIS
Rochester Deep Water CRITICAL WAVE CHARACTERISTICS

At Station 012 Lake Ontario 43° 19' 12" N 77° 27' W
(1985 LWD 243.3) Highest Wind Stress Deep Water Wave Heights for Each Exposure Azimuth.
Depth 210 Feet

Azimuth	Fetch F (Feet)	Wave Period T (Sec)	Wave Length L (Feet)	Wave Height H _r (Feet)	Wind Speed Time Req'd (t-hrs)	Tanh(2πd)L	K _s Shoaling Coefficient	Wind Speed (fps) U _A	Wind Speed (mph) U _A
0.00°	220,000	6.67	548.13	10.24	3.64	0.983907	0.970936	81.05	55.26
22.5°	205,000	6.54	537.67	11.06	3.48	0.985335	0.972762	90.65	61.81
45.0°	412,000	7.35	604.58	11.48	5.71	0.974887	0.960860	68.66	46.81
67.5°	354,000	6.71	552.16	9.42	5.53	0.983335	0.970226	60.06	40.95
292.5°	472,000	7.30	600.35	11.06	6.39	0.975638	0.961618	62.37	42.52
315.0°	320,000	7.21	592.96	11.48	4.70	0.976922	0.962944	76.77	52.34
337.5°	267,000	6.57	540.52	9.42	4.45	0.984954	0.972266	68.09	46.42

WAVE DATA NOMENCLATURE:

d = Water Depth Below DWL (Design Water Level) T = Wave Period (Seconds)
 F = Fetch Length (Feet) H_b = Breaking Wave Height (Feet)
 L = Wave Length (Feet) d_b = Water Depth at Breaking (Feet)
 H_r = Wave Height (Feet) C₂ = Wave Celerity (fps)(ft/sec)
 K_s = Shoaling Coefficient tanh = Hyperbolic Tangent
 U_a = Wind Speed (fps) ft/sec or (mph) miles/hr
 t = Time in hrs to Generate Wave

WAVE INFORMATION STUDIES 1991
WIS REPORT 24
HINDCAST WAVE INFORMATION
STATION 012 43.32°N 77.45°W
DEEP WATER WAVE CHARACTERISTICS WIND SPEEDS AND FREQUENCIES

AZIMUTH 0° 00' Fetch 220,000 Feet Depth 210 Feet (64 Meters)

Return Period (Yrs.)	Significant Wave Height H_o (meters)	Significant Wave Height H_o (feet)	Wind Speed (fps)	Wind Speed (mph)	Percent Frequency of Occurrence
01	0.120	0.394	06.78	04.62	1.182
	0.370	1.214	12.97	08.84	0.729
	0.620	2.034	18.60	12.68	0.403
	0.870	2.854	24.30	16.57	0.142
	1.120	3.675	30.15	20.56	0.133
	1.370	4.495	36.16	24.65	0.052
	1.620	5.315	42.31	28.85	0.022
	1.870	6.135	48.58	33.12	0.014
01	2.120	6.956	54.95	37.46	0.012
02	2.370	7.776	61.38	41.85	0.001
	2.620	8.596	67.88	46.28	0.002
	2.870	9.416	74.43	50.75	0.000
05	3.120	10.237	81.05	55.26	0.001

AZIMUTH 22° 30' Fetch 205,000 Feet Depth 210 Feet (64 Meters)

Return Period (Yrs.)	Significant Wave Height H_o (meters)	Significant Wave Height H_o (feet)	Wind Speed (fps)	Wind Speed (mph)	Percent Frequency of Occurrence
01	0.120	0.394	06.79	04.63	0.762
	0.370	1.214	13.12	08.95	0.422
	0.620	2.034	18.95	12.92	0.296
	0.870	2.854	24.87	16.96	0.096
	1.120	3.675	30.97	21.12	0.075
	1.370	4.495	37.23	25.38	0.025
	1.620	5.315	43.63	29.75	0.013
	1.870	6.135	50.14	34.19	0.004
01	2.120	6.956	56.74	38.69	0.004
02	2.370	7.776	63.41	43.23	0.003
	2.620	8.596	70.14	47.82	0.001
02	2.870	9.416	76.92	52.44	0.000
	3.120	10.237	83.77	57.11	0.002
05	3.370	11.057	90.65	61.81	0.001

WAVE INFORMATION STUDIES 1991
WIS REPORT 24
HINDCAST WAVE INFORMATION
STATION 012 43.32°N 77.45°W
DEEP WATER WAVE CHARACTERISTICS WIND SPEEDS AND FREQUENCIES

AZIMUTH 45° 00' Fetch 412,000 Feet Depth 210 Feet (64 Meters)

Return Period (Yrs.)	Significant Wave Height H_o (meters)	Significant Wave Height H_o (feet)	Wind Speed (fps)	Wind Speed (mph)	Percent Frequency of Occurrence
01	0.120	0.394	06.71	04.57	1.989
	0.370	1.214	12.16	08.29	1.197
	0.620	2.034	16.53	11.27	0.588
	0.870	2.854	20.68	14.10	0.265
	1.120	3.675	24.81	16.92	0.237
	1.370	4.495	28.99	19.77	0.084
	1.620	5.315	33.28	22.69	0.050
	1.870	6.135	37.68	25.69	0.017
	2.120	6.956	42.19	28.77	0.025
	2.370	7.776	46.81	31.92	0.008
	2.620	8.596	51.51	35.12	0.008
	2.870	9.416	56.29	38.38	0.006
	01	3.120	10.237	61.15	41.69
02	3.370	11.057	66.07	45.05	0.003
02	3.500+	11.484+	68.66	46.81	0.001

AZIMUTH 67° 30' Fetch 354,000 Feet Depth 210 Feet (64 Meters)

Return Period (Yrs.)	Significant Wave Height H_o (meters)	Significant Wave Height H_o (feet)	Wind Speed (fps)	Wind Speed (mph)	Percent Frequency of Occurrence	
01	0.120	0.394	06.72	04.58	1.336	
	0.370	1.214	12.29	08.38	0.855	
	0.620	2.034	16.90	11.52	0.457	
	0.870	2.854	21.34	14.55	0.162	
	1.120	3.675	25.81	17.60	0.112	
	1.370	4.495	30.37	20.71	0.032	
	1.620	5.315	35.05	23.90	0.019	
	1.870	6.135	39.85	27.17	0.004	
	2.120	6.956	44.78	30.53	0.005	
	2.370	7.776	49.79	33.95	0.002	
	2.620	8.596	54.89	37.42	0.001	
	01	2.870	9.416	60.06	40.95	0.001

WAVE INFORMATION STUDIES 1991
WIS REPORT 24
HINDCAST WAVE INFORMATION
STATION 012 43.32°N 77.45°W
DEEP WATER WAVE CHARACTERISTICS WIND SPEEDS AND FREQUENCIES

AZIMUTH 292° 30' Fetch 472,000 Feet Depth 210 Feet (64 Meters)

Return Period (Yrs.)	Significant Wave Height H_o (meters)	Significant Wave Height H_o (feet)	Wind Speed (fps)	Wind Speed (mph)	Percent Frequency of Occurrence
01	0.120	0.394	06.70	04.57	4.332
	0.370	1.214	12.06	08.22	3.934
	0.620	2.034	16.26	11.09	3.444
	0.870	2.854	20.18	13.76	1.230
	1.120	3.675	24.04	16.39	0.797
	1.370	4.495	27.93	19.04	0.341
	1.620	5.315	31.89	21.74	0.291
	1.870	6.135	35.96	24.52	0.091
	2.120	6.956	40.14	27.37	0.093
	2.370	7.776	44.42	30.29	0.020
	2.620	8.596	48.78	33.26	0.012
	2.870	9.416	53.24	36.30	0.002
	01	3.120	10.237	57.77	39.39
02	3.370	11.057	62.37	42.52	0.004

AZIMUTH 315° 00' Fetch 320,000 Feet Depth 210 Feet (64 Meters)

Return Period (Yrs.)	Significant Wave Height H_o (meters)	Significant Wave Height H_o (feet)	Wind Speed (fps)	Wind Speed (mph)	Percent Frequency of Occurrence	
01	0.120	0.394	06.73	04.59	1.827	
	0.370	1.214	12.40	08.45	2.335	
	0.620	2.034	17.18	11.71	1.889	
	0.870	2.854	21.85	14.90	0.870	
	1.120	3.675	26.57	18.12	0.785	
	1.370	4.495	31.40	21.41	0.337	
	1.620	5.315	36.37	24.80	0.333	
	1.870	6.135	41.46	28.27	0.119	
	2.120	6.956	46.67	31.82	0.112	
	2.370	7.776	51.96	35.43	0.053	
	01	2.620	8.596	57.33	39.09	0.063
	02	2.870	9.416	62.78	42.80	0.020
		3.120	10.237	68.29	46.56	0.024
	3.370	11.057	73.85	50.35	0.011	
02	3.500+	11.484+	76.77	52.34	0.009	

WAVE INFORMATION STUDIES 1991
WIS REPORT 24
HINDCAST WAVE INFORMATION
STATION 012 43.32°N 77.45°W
DEEP WATER WAVE CHARACTERISTICS WIND SPEEDS AND FREQUENCIES

AZIMUTH 337° 30' Fetch 267,000 Feet Depth 210 Feet (64 Meters)

Return Period (Yrs.)	Significant Wave Height $H_{i(\text{meters})}$	Significant Wave Height $H_{i(\text{feet})}$	Wind Speed (fps)	Wind Speed (mph)	Percent Frequency of Occurrence
01	0.120	0.394	06.74	04.60	0.965
	0.370	1.214	12.64	08.62	0.798
	0.620	2.034	17.79	12.13	0.487
	0.870	2.854	22.91	15.62	0.226
	1.120	3.675	28.15	19.19	0.201
	1.370	4.495	33.52	22.85	0.059
	1.620	5.315	39.03	26.61	0.037
	1.870	6.135	44.67	30.46	0.012
	2.120	6.956	50.41	34.37	0.018
	2.370	7.776	56.24	38.34	0.007
01	2.620	8.596	62.13	42.36	0.005
02	2.870	9.416	68.09	46.42	0.002

**WAVE INFORMATION STUDIES 1991
WIS REPORT 24
HINDCAST WAVE INFORMATION
STATION 012 43.32°N 77.45°W
SUMMARY OF DEEP WATER WAVE CHARACTERISTICS**

Mean Wave Heights in Feet during the Boating Season From 1956- 1987

May	June	July	August	September
4.3	2.9	2.9	2.9	2.9

Largest Wave Heights During Boating Season in Feet From 1956-1987

May	June	July	August	September
12.8	8.6	6.6	6.6	4.3

Mean Peak Wave Period 3.3 Seconds

Most Frequent 22.5 Degree (Center) Direction Band 292.5°

Standard Deviation of Wave HS 1.3 Feet

Standard Deviation of Wave TP (Seconds) 0.8

Largest Wave HS (Feet) 12.5

Wave TP Associated With Largest Wave HS (Seconds) 8.0

Average Direction Associated With Largest Wave HS 305°

SOUNDINGS IN FEET

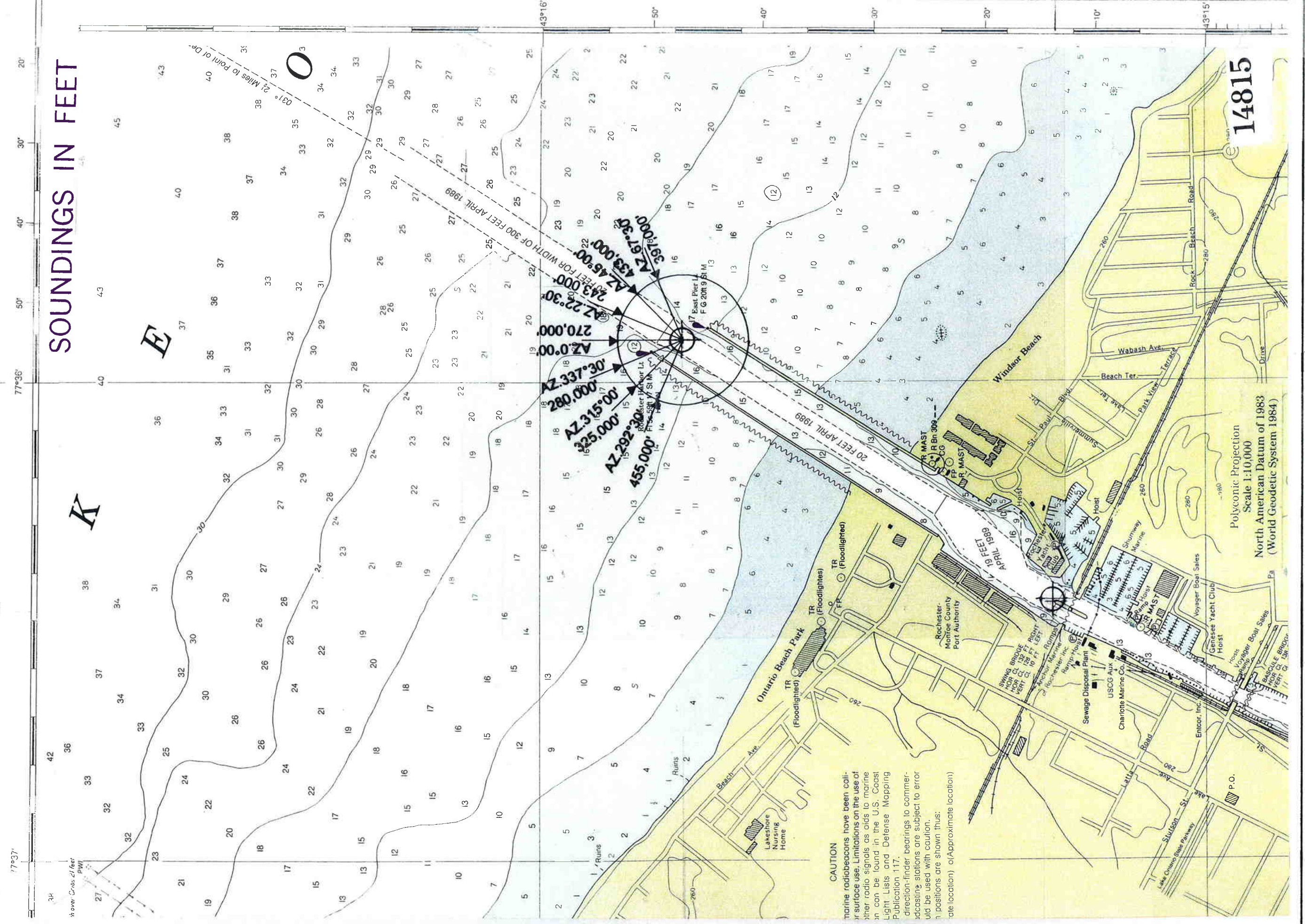

CAUTION
 marine radiobeacons have been collimated for surface use. Limitations on the use of other radio signals as aids to marine navigation can be found in the U.S. Coast and Geodetic Survey Light Lists and Defense Mapping Publication 117.
 direction-finder bearings to commercial stations are subject to error and should be used with caution.
 positions are shown thus:
 (a) location (b) approximate location

DRAWN: _____
 DATE: _____
 PRELIM: _____
 ISSUED: _____
 REVISIONS: _____

PRELIMINARY
 CONSTRUCTION
 FINAL RECORD

CITY OF ROCHESTER NEW YORK
WAVE STUDY

SHEET TITLE: _____
 SCALE: _____

111 NORTH MAIN STREET
 CHEBOYGAN MICHIGAN 49721
 231-827-2288
 231-827-3433
 231-827-8377

uda
 united design associates

JOB NO: _____
 SHEET NO: _____

WIS REPORT 25 DATA

Rochester River Entrance to Lake Ontario CRITICAL WAVE CHARACTERISTICS

Rochester Design Still Water Level 248.23 + 0.48 = 248.71

At the Genesee River Entrance to Lake Ontario 43° 19' 12" N 77° 27' W. Water Depth 20 Feet

(1985 LWD 243.3) Highest Wind Stress Deep Water Wave Heights for Each Exposure Azimuth.

Azimuth	Fetch F (Feet)	Wave Period T (Sec)	Wave Length L (Feet)	Wave Height H _r (Feet)	Wind Speed Time Req'd (t-hrs)	Tanh(2πd)/L	K _s Shoaling Coefficient	Wind Speed (fps) U _A	Wind Speed (mph) U _A
0.00°	270,000	5.38	136.42	5.23	2.21	0.726451	0.927879	81.05	55.26
22.5°	243,000	5.49	139.22	5.54	1.99	0.717564	0.930314	90.65	61.81
45.0°	433,000	5.40	137.08	4.86	2.78	0.724334	0.928444	68.66	46.81
67.5°	397,000	5.12	129.89	4.50	2.93	0.747591	0.922785	60.06	40.95
292.5°	455,000	5.26	133.51	4.62	2.97	0.735802	0.925504	62.37	42.52
315.0°	325,000	5.42	137.48	5.12	2.41	0.723245	0.928738	76.77	52.34
337.5°	280,000	5.11	129.60	4.75	2.47	0.749530	0.922582	68.09	46.42

WAVE DATA NOMENCLATURE:

d = Water Depth Below DWL (Design Water Level)
 F = Fetch Length (Feet)
 L = Wave Length (Feet)
 H_r = Wave Height (Feet)
 K_s = Shoaling Coefficient
 U_a = Wind Speed (fps) ft/sec or (mph) miles/hr
 t = Time in hrs to Generate Wave

T = Wave Period (Seconds)
 H_b = Breaking Wave Height (Feet)
 d_b = Water Depth at Breaking (Feet)
 C₂ = Wave Celerity (fps)(ft/sec)
 tanh = Hyperbolic Tangent

WAVE HEIGHTS TRANSFORMED FROM
STATION 012 43.32°N 77.45°W
DEEP WATER WAVE CHARACTERISTICS WIND SPEEDS AND FREQUENCIES

TO

THE GENESEE RIVER ENTRANCE TO LAKE ONTARIO
AT ROCHESTER NEW YORK, 43° 15' 48" N 77° 35' 48" W

AZIMUTH 0° 00' FETCH 270,000 FEET DEPTH 20 FEET (6.1 Meters)

Return Period (Yrs.)	Significant Wave Height H_o (meters)	Significant Wave Height H_o (feet)	Wind Speed (fps)	Wind Speed (mph)	Percent Frequency of Occurrence
01	0.12	0.39	06.78	04.62	1.182
	0.36	1.18	12.97	08.84	0.729
	0.55	1.81	18.60	12.68	0.403
	0.71	2.32	24.30	16.57	0.142
	0.84	2.76	30.15	20.56	0.133
	0.96	3.16	36.16	24.65	0.052
	1.07	3.52	42.31	28.85	0.022
	1.18	3.86	48.58	33.12	0.014
	01	1.27	4.16	54.95	37.46
02	1.36	4.45	61.38	41.85	0.001
	1.44	4.73	67.88	46.28	0.002
	1.52	4.98	74.43	50.75	0.000
05	1.59	5.23	81.05	55.26	0.001

AZIMUTH 22° 30' Fetch 243,000 Feet Depth 20 Feet (6.1 Meters)

Return Period (Yrs.)	Significant Wave Height H_o (meters)	Significant Wave Height H_o (feet)	Wind Speed (fps)	Wind Speed (mph)	Percent Frequency of Occurrence
01	0.12	0.40	06.79	04.63	0.762
	0.36	1.18	13.12	08.95	0.422
	0.55	1.80	18.95	12.92	0.296
	0.71	2.32	24.87	16.96	0.096
	0.84	2.77	30.97	21.12	0.075
	0.97	3.18	37.23	25.38	0.025
	1.08	3.55	43.63	29.75	0.013
	1.18	3.89	50.14	34.19	0.004
	01	1.28	4.20	56.74	38.69
02	1.37	4.50	63.41	43.23	0.003
	1.46	4.78	70.14	47.82	0.001
02	1.54	5.04	76.92	52.44	0.000
	1.61	5.30	83.77	57.11	0.002
05	1.69	5.54	90.65	61.81	0.001

**WAVE HEIGHTS TRANSFORMED FROM
STATION 012 43.32°N 77.45°W
DEEP WATER WAVE CHARACTERISTICS WIND SPEEDS AND FREQUENCIES**

TO

**THE GENESEE RIVER ENTRANCE TO LAKE ONTARIO
AT ROCHESTER NEW YORK, 43° 15' 48" N 77° 35' 48" W**

AZIMUTH 45° 00' Fetch 433,000 Feet Depth 20 Feet (6.1 Meters)

Return Period (Yrs.)	Significant Wave Height H_o (meters)	Significant Wave Height H_o (feet)	Wind Speed (fps)	Wind Speed (mph)	Percent Frequency of Occurrence
01	0.12	0.39	06.71	04.57	1.989
	0.35	1.14	12.16	08.29	1.197
	0.52	1.71	16.53	11.27	0.588
	0.66	2.16	20.68	14.10	0.265
	0.77	2.53	24.81	16.92	0.237
	0.87	2.86	28.99	19.77	0.084
	0.96	3.15	33.28	22.69	0.050
	1.04	3.42	37.68	25.69	0.017
	1.12	3.68	42.19	28.77	0.025
	1.19	3.92	46.81	31.92	0.008
	1.26	4.14	51.51	35.12	0.008
	1.33	4.36	56.29	38.38	0.006
	01	1.39	4.57	61.15	41.69
02	1.45	4.76	66.07	45.05	0.003
02	1.48	4.86	68.66	46.81	0.001

AZIMUTH 67° 30' Fetch 397,000 Feet Depth 20 Feet (6.1 Meters)

Return Period (Yrs.)	Significant Wave Height H_o (meters)	Significant Wave Height H_o (feet)	Wind Speed (fps)	Wind Speed (mph)	Percent Frequency of Occurrence	
01	0.12	0.39	06.72	04.58	1.336	
	0.35	1.15	12.29	08.38	0.855	
	0.53	1.74	16.90	11.52	0.457	
	0.67	2.20	21.34	14.55	0.162	
	0.79	2.59	25.81	17.60	0.112	
	0.89	2.93	30.37	20.71	0.032	
	0.99	3.24	35.05	23.90	0.019	
	1.07	3.52	39.85	27.17	0.004	
	1.16	3.79	44.78	30.53	0.005	
	1.23	4.04	49.79	33.95	0.002	
	1.30	4.28	54.89	37.42	0.001	
	01	1.37	4.50	60.06	40.95	0.001

**WAVE HEIGHTS TRANSFORMED FROM
STATION 012 43.32°N 77.45°W
DEEP WATER WAVE CHARACTERISTICS WIND SPEEDS AND FREQUENCIES**

TO

**THE GENESEE RIVER ENTRANCE TO LAKE ONTARIO
AT ROCHESTER NEW YORK, 43° 15' 48" N 77° 35' 48" W**

AZIMUTH 292° 30' Fetch 455,000 Feet Depth 20 Feet (6.1 Meters)

Return Period (Yrs.)	Significant Wave Height H_o (meters)	Significant Wave Height H_o (feet)	Wind Speed (fps)	Wind Speed (mph)	Percent Frequency of Occurrence	
01	0.12	0.39	06.70	04.57	4.332	
	0.35	1.13	12.06	08.22	3.934	
	0.52	1.69	16.26	11.09	3.444	
	0.65	2.12	20.18	13.76	1.230	
	0.76	2.48	24.04	16.39	0.797	
	0.85	2.79	27.93	19.04	0.341	
	0.94	3.07	31.89	21.74	0.291	
	1.02	3.33	35.96	24.52	0.091	
	1.09	3.58	40.14	27.37	0.093	
	1.16	3.81	44.42	30.29	0.020	
	1.23	4.02	48.78	33.26	0.012	
	1.29	4.23	53.24	36.30	0.002	
	01	1.35	4.43	57.77	39.39	0.001
	02	1.41	4.62	62.37	42.52	0.004

AZIMUTH 315° 00' Fetch 325,000 Feet Depth 20 Feet (6.1 Meters)

Return Period (Yrs.)	Significant Wave Height H_o (meters)	Significant Wave Height H_o (feet)	Wind Speed (fps)	Wind Speed (mph)	Percent Frequency of Occurrence	
01	0.12	0.39	06.73	04.59	1.827	
	0.35	1.14	12.40	08.45	2.335	
	0.52	1.72	17.18	11.71	1.889	
	0.66	2.18	21.85	14.90	0.870	
	0.79	2.58	26.57	18.12	0.785	
	0.89	2.93	31.40	21.41	0.337	
	0.99	3.25	36.37	24.80	0.333	
	1.08	3.55	41.46	28.27	0.119	
	1.17	3.83	46.67	31.82	0.112	
	1.25	4.09	51.96	35.43	0.053	
	01	1.32	4.34	57.33	39.09	0.063
	02	1.39	4.57	62.78	42.80	0.020
		1.46	4.80	68.29	46.56	0.024
		1.53	5.01	73.85	50.35	0.011
02	1.56	5.12	76.77	52.34	0.009	

WAVE HEIGHTS TRANSFORMED FROM
 STATION 012 43.32°N 77.45°W
 DEEP WATER WAVE CHARACTERISTICS WIND SPEEDS AND FREQUENCIES

TO

THE GENESEE RIVER ENTRANCE TO LAKE ONTARIO
 AT ROCHESTER NEW YORK, 43° 15' 48" N 77° 35' 48" W

AZIMUTH 337° 30' Fetch 280,000 Feet Depth 20 Feet (6.1 Meters)

Return Period (Yrs.)	Significant Wave Height H _{o(meters)}	Significant Wave Height H _{o(feet)}	Wind Speed (fps)	Wind Speed (mph)	Percent Frequency of Occurrence
01	0.12	0.39	06.74	04.60	0.965
	0.35	1.15	12.64	08.62	0.798
	0.53	1.74	17.79	12.13	0.487
	0.68	2.22	22.91	15.62	0.226
	0.80	2.63	28.15	19.19	0.201
	0.92	3.01	33.52	22.85	0.059
	1.02	3.35	39.03	26.61	0.037
	1.12	3.67	44.67	30.46	0.012
	1.21	3.96	50.41	34.37	0.018
	1.29	4.24	56.24	38.34	0.007
01	1.37	4.50	62.13	42.36	0.005
02	1.45	4.75	68.09	46.42	0.002

in over Cross 2/feet PWI

SOUNDINGS IN FEET

K

E

03° 21 Miles to Point of Dep.

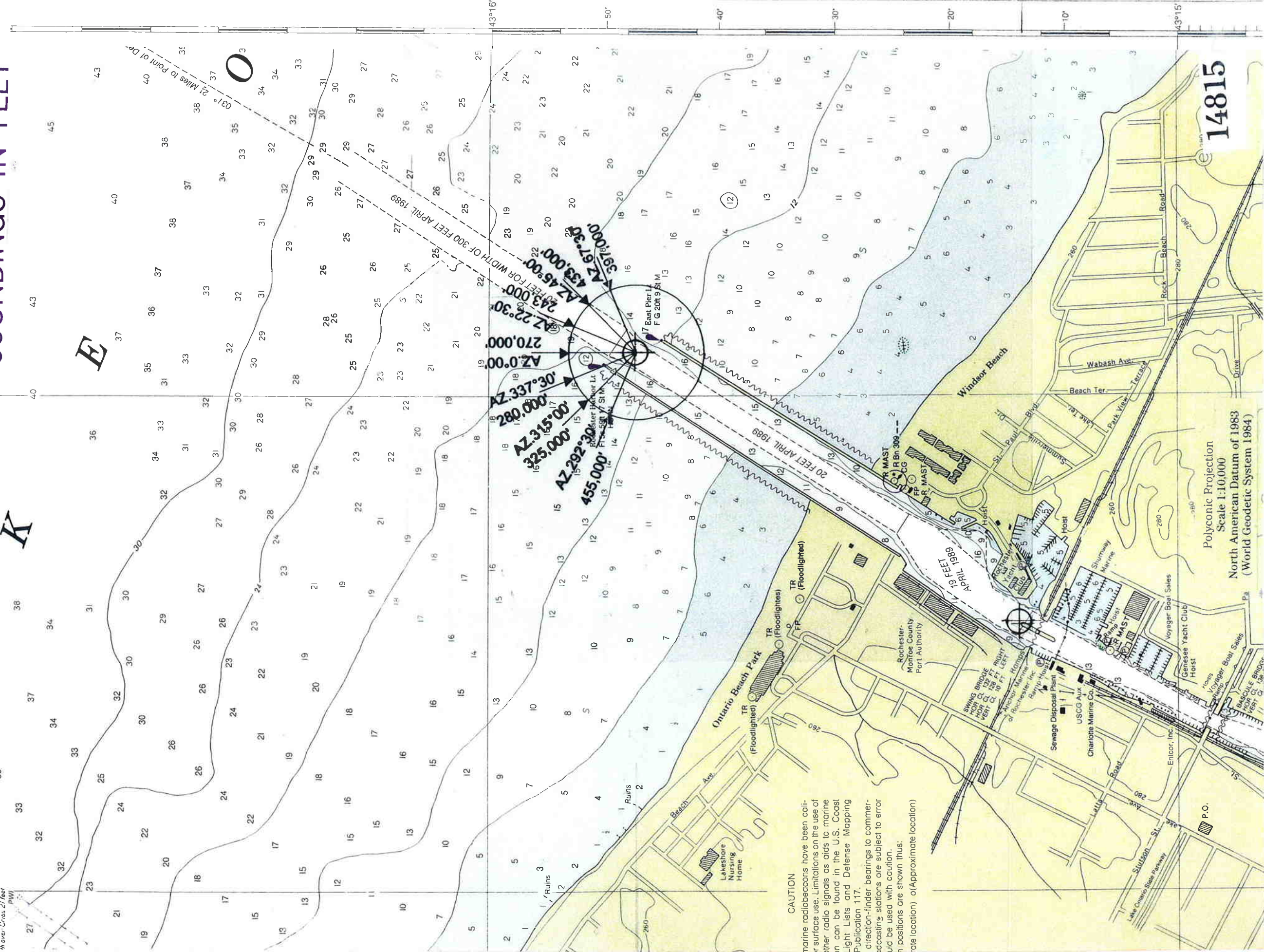

CAUTION
 marine radiobeacons have been col-
 or surface use. Limitations on the use of
 other radio signals as aids to marine
 navigation can be found in the U.S. Coast
 Light Lists and Defense Mapping
 Publication 117.
 direction-inder bearings to commer-
 cial stations are subject to error
 and should be used with caution.
 in positions are shown thus:
 (approximate location) a (Approximate location)

Polyconic Projection
 Scale 1:10,000
 North American Datum of 1983
 (World Geodetic System 1984)

14815

JOB NO:
 SHEET NO:

111 NORTH MAIN STREET
 CHEBOYGAN
 MICHIGAN 49721
uda
 united design associates
 231-857-2268
 231-857-3431
 FAX 231-857-9377

SHEET TITLE:
 SCALE:

CITY OF
 ROCHESTER NEW YORK
 WAVE STUDY

PRELIMINARY
 CONSTRUCTION
 FINAL RECORD

DRAWN:
 DATE:
 PRELIM:
 ISSUED:
 REVISIONS:

WIS REPORT 25 DATA

Rochester Design Still Water Level 248.23 + 0.48 = 248.71

At the Proposed Boat Harbor Entrance Area to Lake Ontario 43° 15' 14" N, 77° 36' 29" W.
Water Depth 19 Feet

(1985 LWD 243.3) Highest Wind Stress Deep Water Wave Heights for Each Exposure Azimuth.

Azimuth	Fetch F (Feet)	Wave Period T (Sec)	Wave Length L (Feet)	Wave Height H _r (Feet)	Wind Speed Time Req'd (t-hrs)	Tanh(2πd)/L	K _s Shoaling Coefficient	Wind Speed (fps) U _a	Wind Speed (mph) U _a
0.00°	274,250	5.33	131.86	5.06	2.16	0.718892	0.929939	81.05	55.26
22.5°	247,250	5.44	134.65	5.35	1.96	0.709703	0.932612	90.65	61.81
45.0°	437,250	5.34	132.16	4.69	2.71	0.717904	0.930218	68.66	46.81
67.5°	401,250	5.07	125.32	4.35	2.86	0.740958	0.924277	60.06	40.95
292.5°	459,250	5.20	120.71	4.46	2.89	0.729437	0.927100	62.37	42.52
315.0°	329,250	5.36	132.69	4.94	2.36	0.716162	0.930714	76.77	52.34
337.5°	284,250	5.06	125.28	4.59	2.42	0.741098	0.924245	68.09	46.42

WAVE DATA NOMENCLATURE:

d = Water Depth Below DWL (Design Water Level) T = Wave Period (Seconds)
 F = Fetch Length (Feet) H_b = Breaking Wave Height (Feet)
 L = Wave Length (Feet) d_b = Water Depth at Breaking (Feet)
 H_r = Wave Height (Feet) C₂ = Wave Celerity (fps)(ft/sec)
 K_s = Shoaling Coefficient tanh = Hyperbolic Tangent
 U_a = Wind Speed (fps) ft/sec or (mph) miles/hr
 t = Time in hrs to Generate Wave

**WAVE HEIGHTS TRANSFORMED FROM
STATION 012 43.32°N 77.45°W
DEEP WATER WAVE CHARACTERISTICS WIND SPEEDS AND FREQUENCIES**

TO

**THE PROPOSED BOAT HARBOR ENTRANCE AREA
43° 15'14" N, 77° 36' 29" W**

AZIMUTH 0° 00' FETCH 274,250 FEET DEPTH 19 FEET (5.79 Meters)

Return Period (Yrs.)	Significant Wave Height H_i (meters)	Significant Wave Height H_i (feet)	Wind Speed (fps)	Wind Speed (mph)	Percent Frequency of Occurrence
01	0.12	0.40	06.78	04.62	1.182
	0.36	1.18	12.97	08.84	0.729
	0.54	1.78	18.60	12.68	0.403
	0.69	2.28	24.30	16.57	0.142
	0.82	2.71	30.15	20.56	0.133
	0.94	3.09	36.16	24.65	0.052
	1.05	3.43	42.31	28.85	0.022
	1.14	3.75	48.58	33.12	0.014
	01	1.23	4.04	54.95	37.46
02	1.32	4.32	61.38	41.85	0.001
	1.39	4.58	67.88	46.28	0.002
	1.47	4.82	74.43	50.75	0.000
05	1.54	5.06	81.05	55.26	0.001

TO

**THE PROPOSED BOAT HARBOR ENTRANCE AREA
43° 15'14" N, 77° 36' 29" W**

AZIMUTH 22° 30' Fetch 247,250 Feet Depth 19 Feet (5.79 Meters)

Return Period (Yrs.)	Significant Wave Height H_i (meters)	Significant Wave Height H_i (feet)	Wind Speed (fps)	Wind Speed (mph)	Percent Frequency of Occurrence
01	0.12	0.40	06.79	04.63	0.762
	0.36	1.17	13.12	08.95	0.422
	0.54	1.78	18.95	12.92	0.296
	0.69	2.28	24.87	16.96	0.096
	0.83	2.72	30.97	21.12	0.075
	0.95	3.10	37.23	25.38	0.025
	1.05	3.46	43.63	29.75	0.013
	1.15	3.78	50.14	34.19	0.004
	01	1.25	4.09	56.74	38.69
02	1.33	4.37	63.41	43.23	0.003
	1.41	4.63	70.14	47.82	0.001
02	1.49	4.88	76.92	52.44	0.000
	1.56	5.12	83.77	57.11	0.002
05	1.63	5.35	90.65	61.81	0.001

**WAVE HEIGHTS TRANSFORMED FROM
STATION 012 43.32°N 77.45°W
DEEP WATER WAVE CHARACTERISTICS WIND SPEEDS AND FREQUENCIES**

TO

**THE PROPOSED BOAT HARBOR ENTRANCE AREA
43° 15'14" N, 77° 36' 29" W**

AZIMUTH 45° 00' Fetch 437,250 Feet Depth 19 Feet (5.79 Meters)

Return Period (Yrs.)	Significant Wave Height H_i (meters)	Significant Wave Height H_i (feet)	Wind Speed (fps)	Wind Speed (mph)	Percent Frequency of Occurrence
01	0.12	0.39	06.71	04.57	1.989
	0.35	1.13	12.16	08.29	1.197
	0.51	1.69	16.53	11.27	0.588
	0.64	2.11	20.68	14.10	0.265
	0.75	2.45	24.81	16.92	0.237
	0.85	2.78	28.99	19.77	0.084
	0.93	3.06	33.28	22.69	0.050
	1.01	3.32	37.68	25.69	0.017
	1.09	3.56	42.19	28.77	0.025
	1.15	3.79	46.81	31.92	0.008
	1.22	4.00	51.51	35.12	0.008
	1.28	4.21	56.29	38.38	0.006
	01	1.34	4.41	61.15	41.69
02	1.40	4.60	66.07	45.05	0.003
02	1.43	4.69	68.66	46.81	0.001

TO

**THE PROPOSED BOAT HARBOR ENTRANCE AREA
43° 15'14" N, 77° 36' 29" W**

AZIMUTH 67° 30' Fetch 401,250 Feet Depth 19 Feet (5.79 Meters)

Return Period (Yrs.)	Significant Wave Height H_i (meters)	Significant Wave Height H_i (feet)	Wind Speed (fps)	Wind Speed (mph)	Percent Frequency of Occurrence	
01	0.12	0.39	06.72	04.58	1.336	
	0.35	1.14	12.29	08.38	0.855	
	0.52	1.71	16.90	11.52	0.457	
	0.66	2.15	21.34	14.55	0.162	
	0.77	2.53	25.81	17.60	0.112	
	0.87	2.85	30.37	20.71	0.032	
	0.96	3.15	35.05	23.90	0.019	
	1.04	3.42	39.85	27.17	0.004	
	1.12	3.67	44.78	30.53	0.005	
	1.19	3.91	49.79	33.95	0.002	
	1.26	4.14	54.89	37.42	0.001	
	01	1.33	4.35	60.06	40.95	0.001

**WAVE HEIGHTS TRANSFORMED FROM
STATION 012 43.32°N 77.45°W
DEEP WATER WAVE CHARACTERISTICS WIND SPEEDS AND FREQUENCIES**

TO

**THE PROPOSED BOAT HARBOR ENTRANCE AREA
43° 15'14" N, 77° 36' 29" W**

AZIMUTH 292° 30' Fetch 459,250 Feet Depth 19 Feet (5.79 Meters)

Return Period (Yrs.)	Significant Wave Height H_i (meters)	Significant Wave Height H_i (feet)	Wind Speed (fps)	Wind Speed (mph)	Percent Frequency of Occurrence	
01	0.12	0.39	06.70	04.57	4.232	
	0.34	1.13	12.06	08.22	3.934	
	0.51	1.66	16.26	11.09	3.444	
	0.63	2.08	20.18	13.76	1.230	
	0.74	2.42	24.04	16.39	0.797	
	0.83	2.72	27.93	19.04	0.341	
	0.91	2.99	31.89	21.74	0.291	
	0.99	2.23	35.96	24.52	0.091	
	1.06	3.46	40.14	27.37	0.093	
	1.12	3.68	44.42	30.29	0.020	
	1.19	3.89	48.78	33.26	0.012	
	1.25	4.09	53.24	36.30	0.002	
	01	1.30	4.28	57.77	39.39	0.001
	02	1.36	4.46	62.37	42.52	0.004

TO

**THE PROPOSED BOAT HARBOR ENTRANCE AREA
43° 15'14" N, 77° 36' 29" W**

AZIMUTH 315° 00' Fetch 329,250 Feet Depth 19 Feet (5.79 Meters)

Return Period (Yrs.)	Significant Wave Height H_i (meters)	Significant Wave Height H_i (feet)	Wind Speed (fps)	Wind Speed (mph)	Percent Frequency of Occurrence	
01	0.12	0.39	06.73	04.59	1.827	
	0.35	1.13	12.40	08.45	2.335	
	0.52	1.69	17.18	11.71	1.889	
	0.65	2.14	21.85	14.90	0.870	
	0.77	2.52	26.57	18.12	0.785	
	0.87	2.86	31.40	21.41	0.337	
	0.96	3.17	36.37	24.80	0.333	
	1.05	3.45	41.46	28.27	0.119	
	1.13	3.71	46.67	31.82	0.112	
	1.21	3.96	51.96	35.43	0.053	
	01	1.28	4.20	57.33	39.09	0.063
	02	1.35	4.42	62.78	42.80	0.020
		1.41	4.64	68.29	46.56	0.024
	02	1.48	4.84	73.85	50.35	0.011
1.51		4.94	76.77	52.34	0.009	

**WAVE HEIGHTS TRANSFORMED FROM
STATION 012 43.32°N 77.45°W
DEEP WATER WAVE CHARACTERISTICS WIND SPEEDS AND FREQUENCIES**

TO

**THE PROPOSED BOAT HARBOR ENTRANCE AREA
43° 15'14" N, 77° 36' 29" W**

AZIMUTH 337° 30' Fetch 284,250 Feet Depth 19 Feet (5.79 Meters)

Return Period (Yrs.)	Significant Wave Height H_i (meters)	Significant Wave Height H_i (feet)	Wind Speed (fps)	Wind Speed (mph)	Percent Frequency of Occurrence
01	0.12	0.39	06.74	04.60	0.965
	0.35	1.14	12.64	08.62	0.798
	0.52	1.71	17.79	12.13	0.487
	0.66	2.18	22.91	15.62	0.226
	0.79	2.58	28.15	19.19	0.201
	0.90	2.94	33.52	22.85	0.059
	1.00	3.27	39.03	26.61	0.037
	1.09	3.57	44.67	30.46	0.012
	1.17	3.85	50.41	34.37	0.018
	1.25	4.11	56.24	38.34	0.007
01	1.33	4.36	62.13	42.36	0.005
02	1.40	4.59	68.09	46.42	0.002

IV. Marina Entrance Recommendations

Based upon the summary of information, including size and occurrence of waves, alternatives available for dampening wave energies and our experience with marinas, our team has the following recommendations:

A. Initial Entrance Design

The initial marina entrance design should include:

- Construct a stone revetment throughout the interior of the marina basin walls to reduce wave energies.
- Construct wave attenuating floating dockage containing baffle systems for dockage within the marina basin.
- Construct a narrow marina entrance per the attached drawings with a 60' width. (see Appendix)
- Construct wave attenuating devices, including an improved baffle wall system off the existing debris wall on the up and downstream side of the existing ferry platform structure.
- Construct floating wave attenuators which could also be used as transient dockage/access docks on the up and downstream side of the ferry terminal building.

It is anticipated that this work will result in wave energies significantly less than other nearby marinas, i.e., Rochester Yacht Club, Shumway Marine, etc., however, on a few occurrences during the boating season, waves could exceed 1' inside the marina basin. Again, a Great Lakes standard would be for waves less than 6", however, locally in the Rochester Harbor, boaters are accustomed to worse conditions, given the configuration of the marina locations relative to the existing Army Corps of Engineers' breakwaters.

B. Future Wave Improvements

A future wave improvement program would be to construct a hydraulic gate inside the entrance described above where the gate would mechanically close the entrance during storm events and perhaps during the winter. This would further protect the dockage inside the marina from ice damage and wave energies to assure meeting a design standard of less than 6" waves in the marina basin. The gate concept could be phased with construction in the future, after experience of operating the marina warrants additional construction and operation of this gate device.

V. Actual Wave Observations

In reviewing the ideal entrance configurations and wave studies, additional actual wave observations and research were conducted by the study team during the course of this assignment. These observations included both review of a minor northeasterly storm event on March 24, 2009, in addition to meetings and discussions with area marina owners and operators, including Rochester Yacht Club and its boaters, and Skip Shumway of Shumway Marine. The following summarizes the actual observations in the harbor.

A. Actual Wind and Wave Observations

Rochester, New York

Waves were observed on March 24, 2009 between 12:00 noon and 5:00 p.m. by Ronald Schults, Dan Savage, Tim Hubbard and Tim Harris.

1. Steady winds out of the northeast at approximately 10 to 15 knots
2. Observations
 - A. Lake Ontario sea conditions: 2' to 4'
 - B. From the inner harbor near the Coast Guard Station: 18" to 24"
 - C. At the Sasaki entrance: 18"
 - D. In front of the Rochester Yacht Club: 18" to 24"
 - E. North of the ferry terminal ramp: 12"
 - F. South of the ferry terminal ramp: 8" to 12"
 - G. In the boat launch itself: 12" (harmonic condition between vertical walls)
 - H. At Rochester Yacht Club in their marina entrance: 6" movement
 - I. In the northeasterly section of Rochester Yacht Club: ± 2 " vertical water movement on piles
 - J. Upstream south of railroad bridge

The conclusion of the above is that waves dissipate significantly as they enter the Rochester Harbor from Lake Ontario and reach the upper river limit of the railroad trestle. These observed waves/surge conditions range from 3' to 4' at the outside of the harbor and reduce to 1' to 2' inside the harbor, with a further reduction of 2" or less inside Rochester Yacht Club's northeasterly corner of their basin.

The following photographs were taken depicting these wave conditions on March 24, 2009:

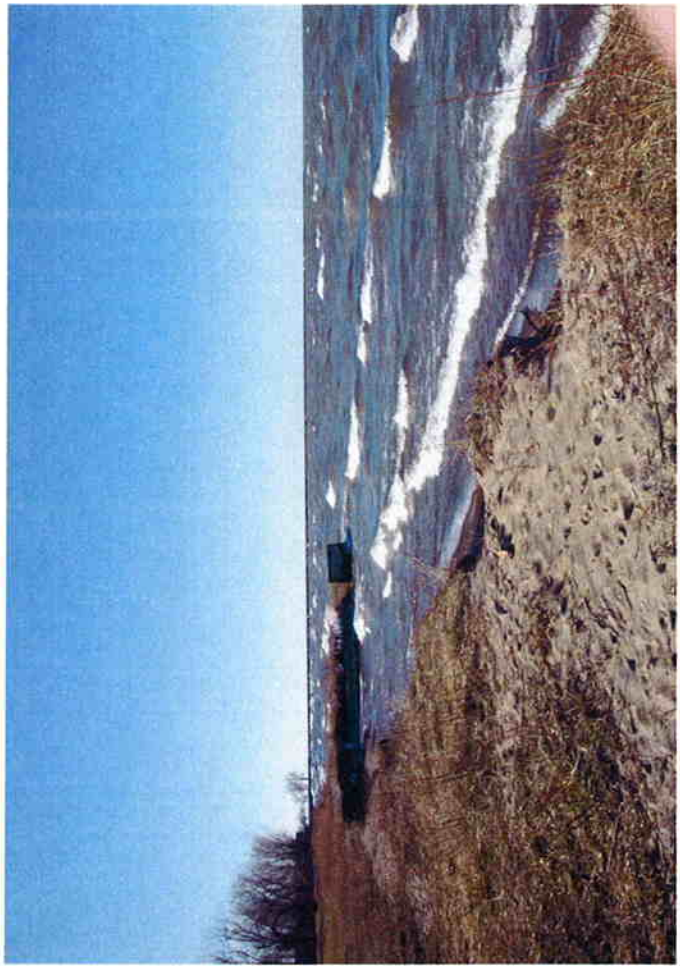
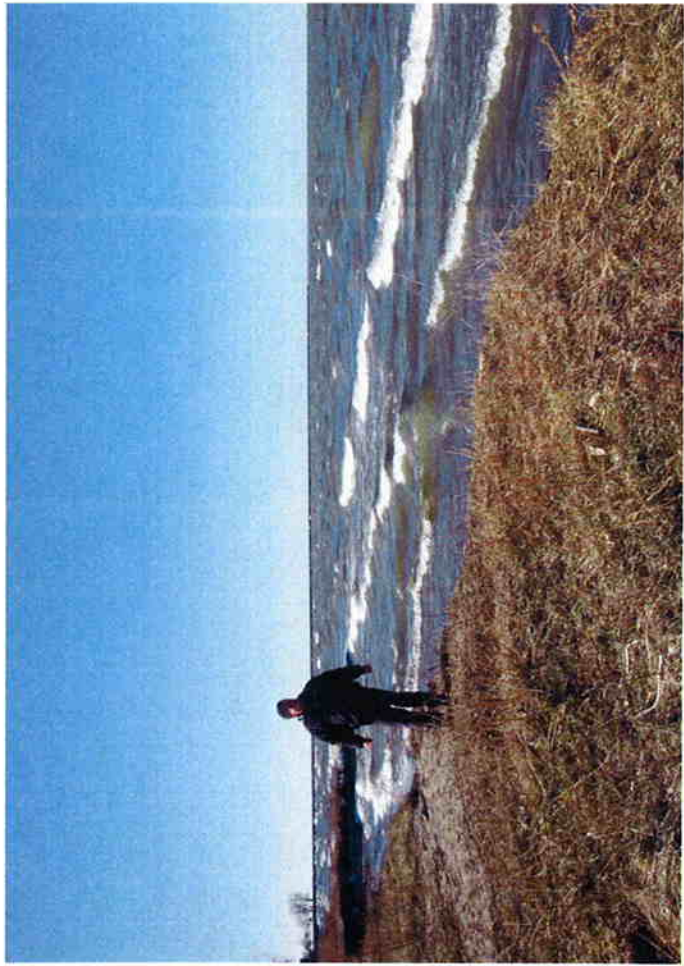

Rochester Harbor Photos - 03/24/09

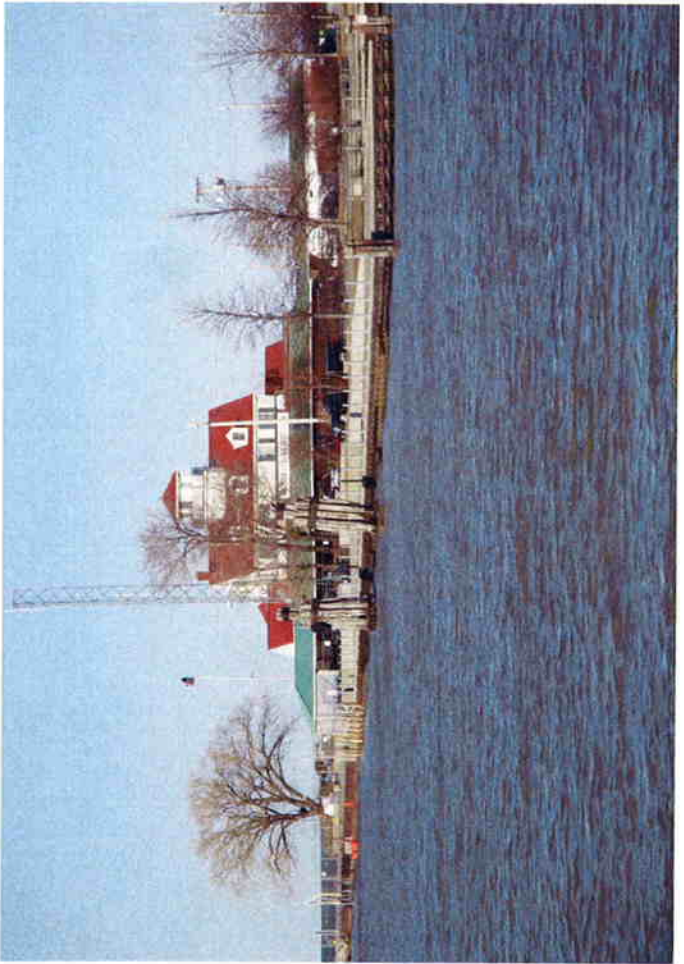
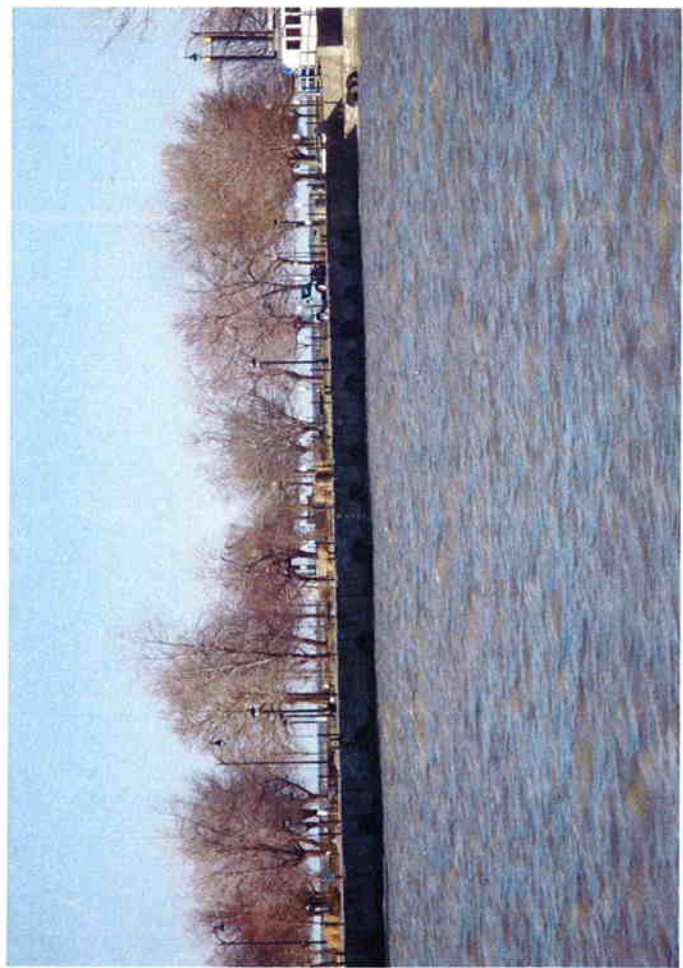

Rochester Harbor Photos - 03/24/09

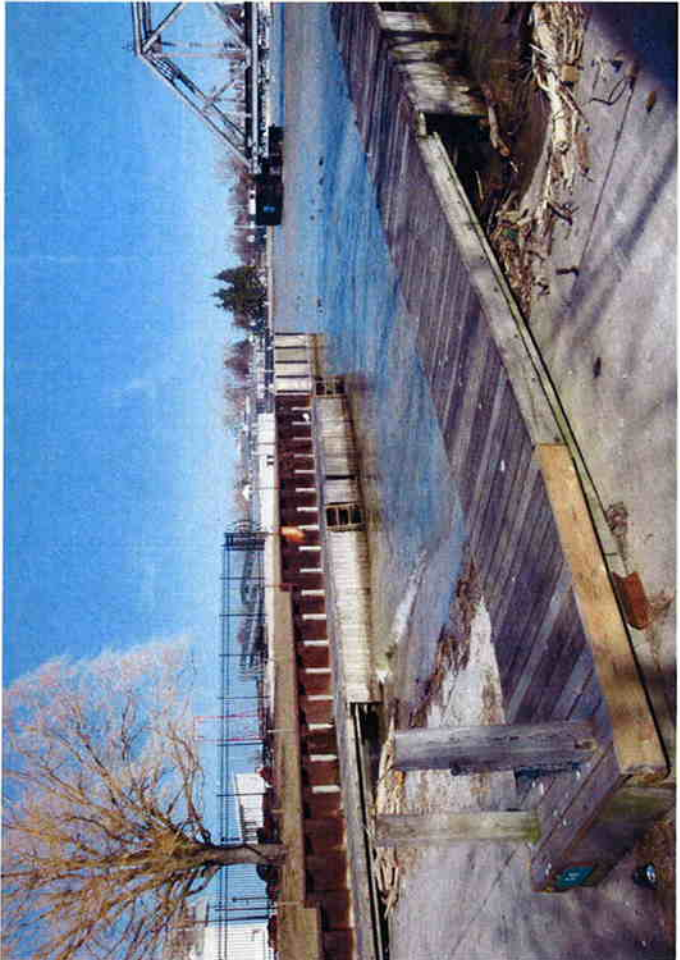
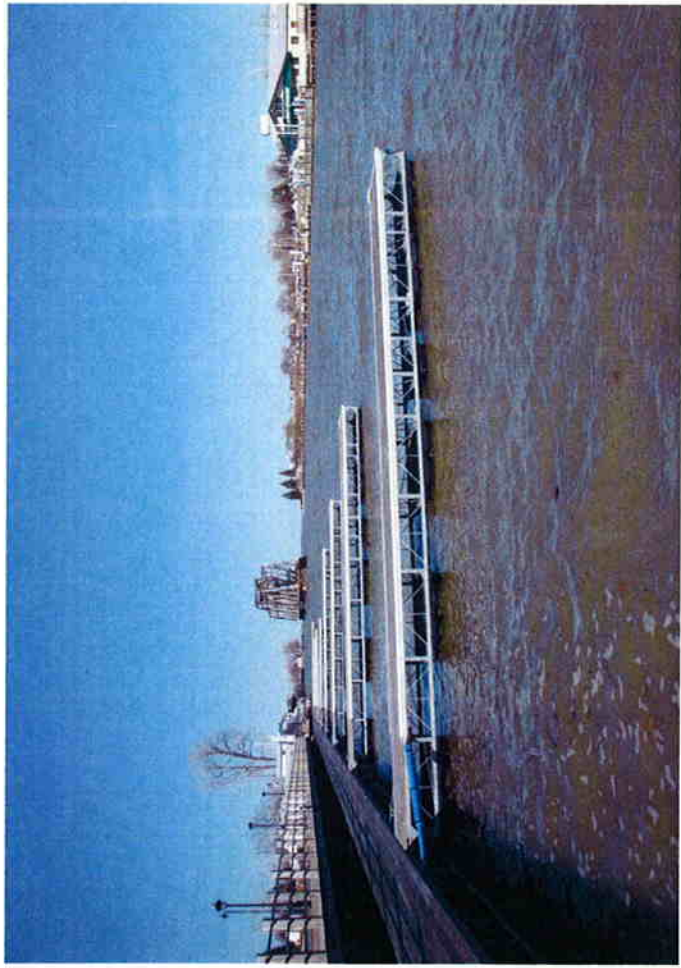

Rochester Harbor Photos - 03/24/09

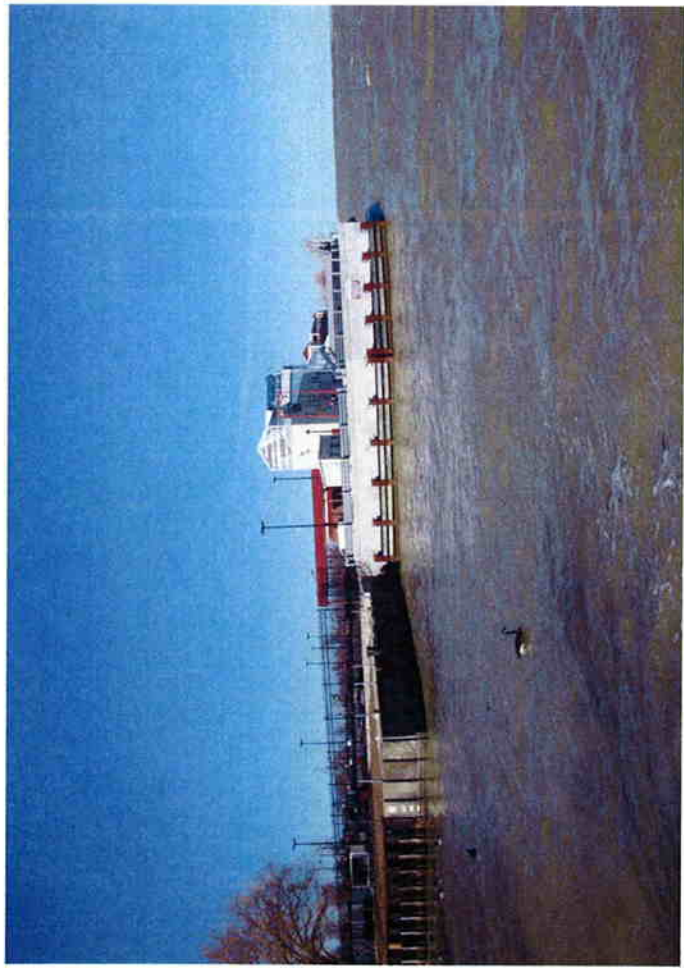

Rochester Harbor Photos - 03/24/09

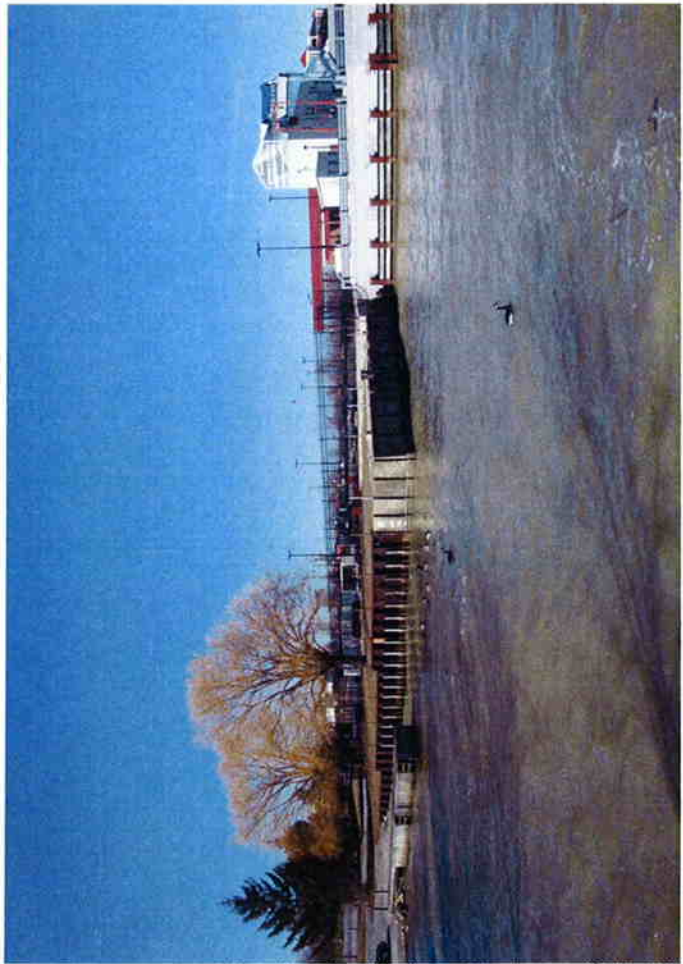
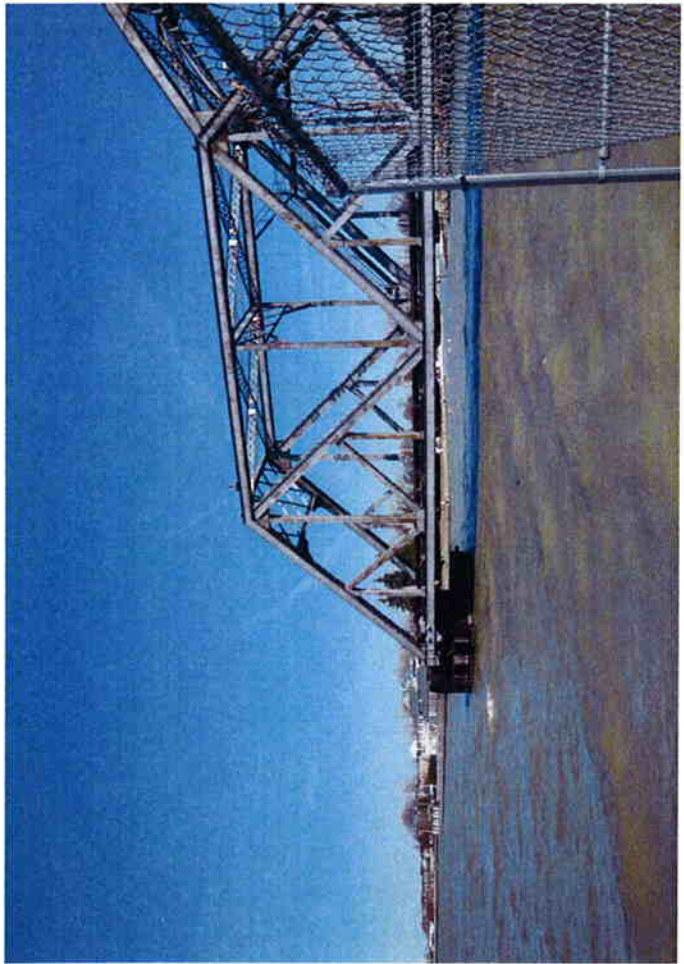

Rochester Harbor Photos - 03/24/09

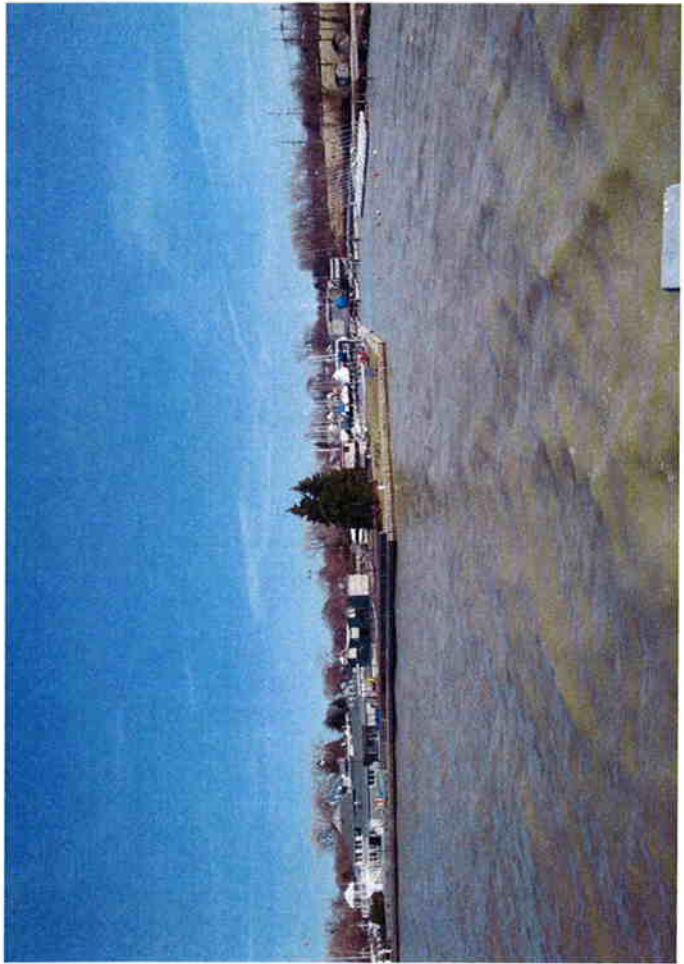

Rochester Harbor Photos - 03/24/09

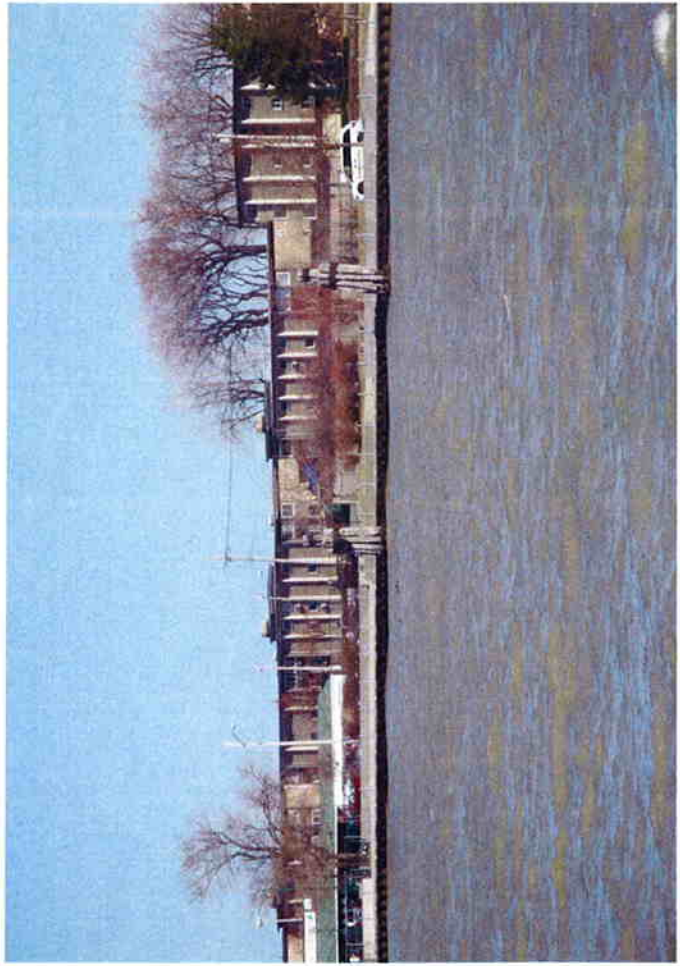
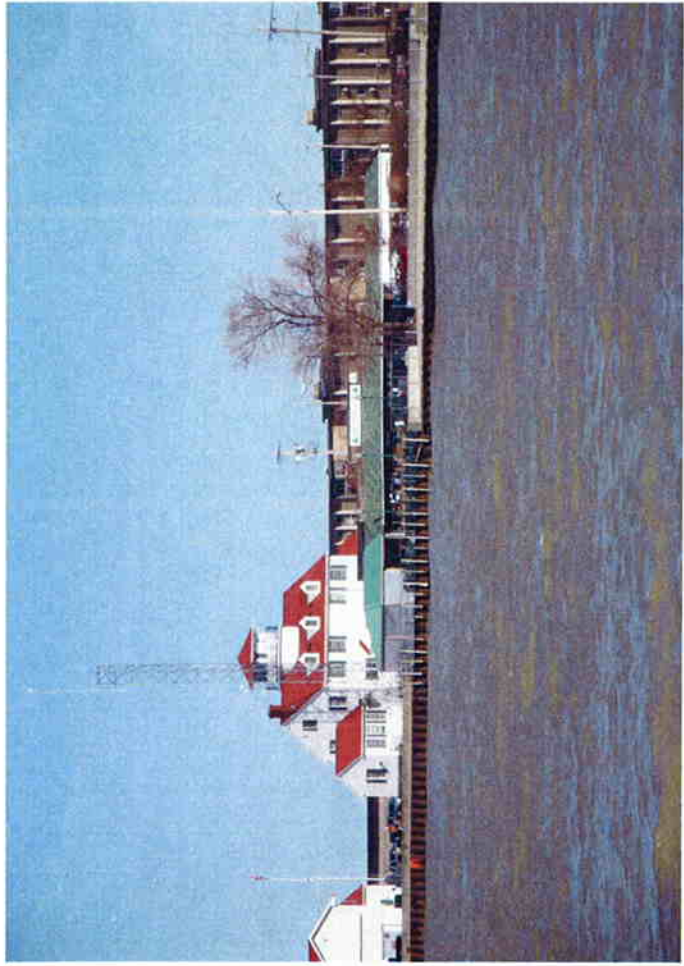

Rochester Harbor Photos - 03/24/09

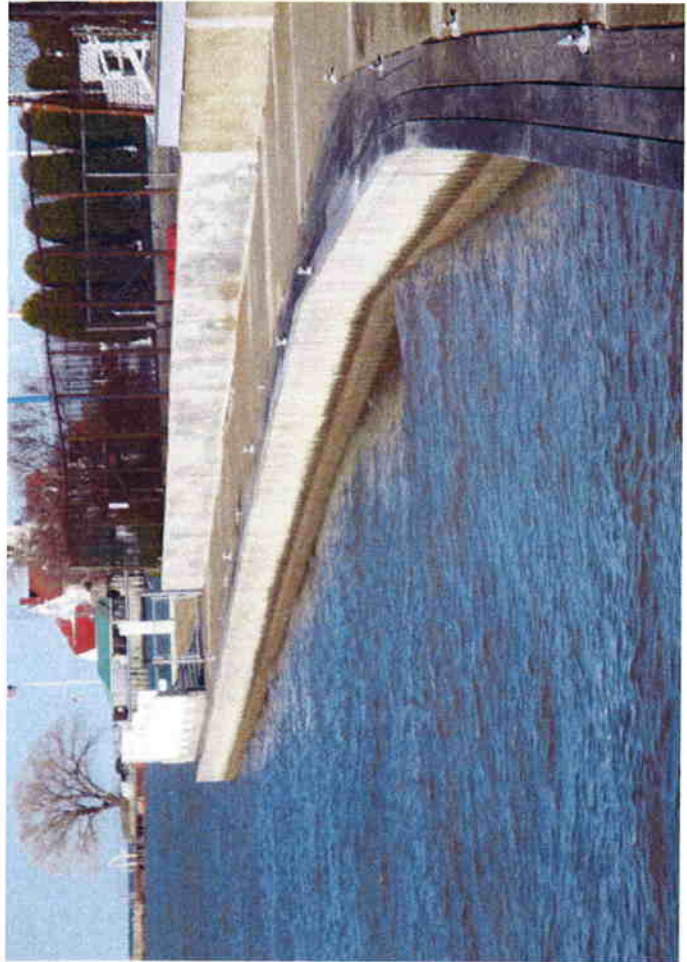
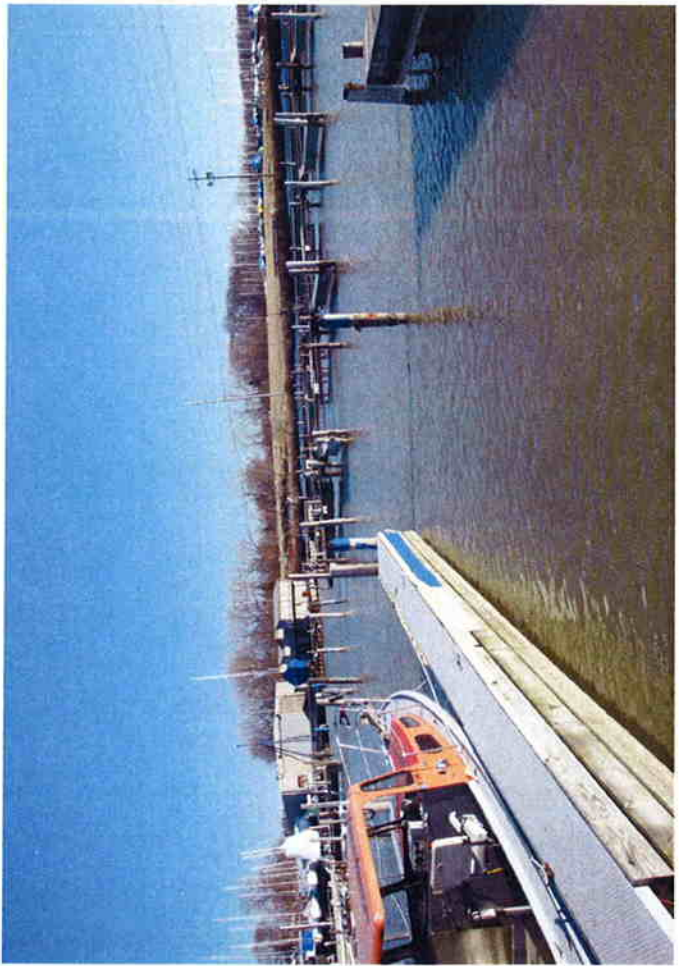

Rochester Harbor Photos - 03/24/09

B. Shumway Video Photos

Shumway Marine provided photographs and a video taken on February 6, 2008 of a 15- to 25-knot sustained northeasterly storm with the sea conditions as identified on the photos/video. The waves in the harbor ranged from 8' to 12'. The photographs speak for themselves, however, show the amount of surge and large waves that occur at the outside of the Army Corps breakwater and as they enter upstream and past the railroad trestle.

The conclusion of these photos and video is that anticipated waves at the proposed marina entrance near the Monroe County boat launch will be in the 1' to 3' range and will dissipate significantly as they enter the marina basin, assuming the sides of the basin are armored with a wave-dissipating, stone revetment. Based upon discussions with Rochester Yacht Club boaters, this surge occurs a few times during the boating season; however, it is acceptable given the alternative of not boating.

It should be noted that the entrance configuration and size for the port marina will perform much better than the existing Rochester Yacht Club entrance due to the following:

- Port marina entrance is 60' wide with stone on both sides. (Rochester Yacht Club is 150' wide with vertical wall on one side.)
- Port marina entrance is angled to the north making it more difficult for waves to enter the marina basin. (Rochester Yacht Club and Shumway's entrance is at 90° to the river.)
- Port marina entrance will have sufficient wave-attenuating structures (2 baffle walls and floating wave attenuators both sides of the ferry terminal platform) which do not exist at Rochester Yacht Club or Shumway Marine.

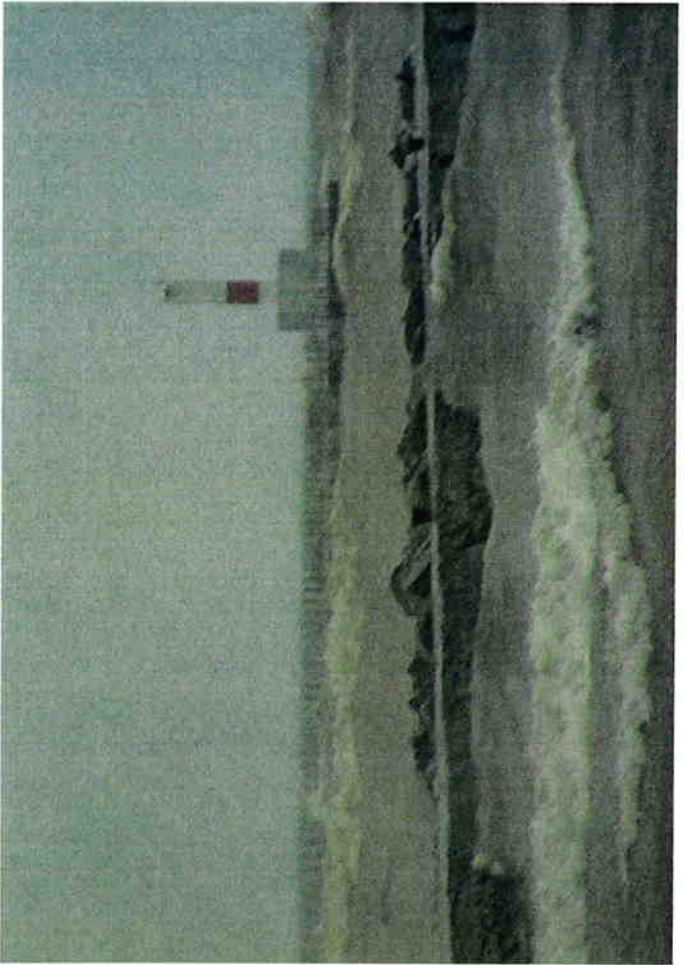
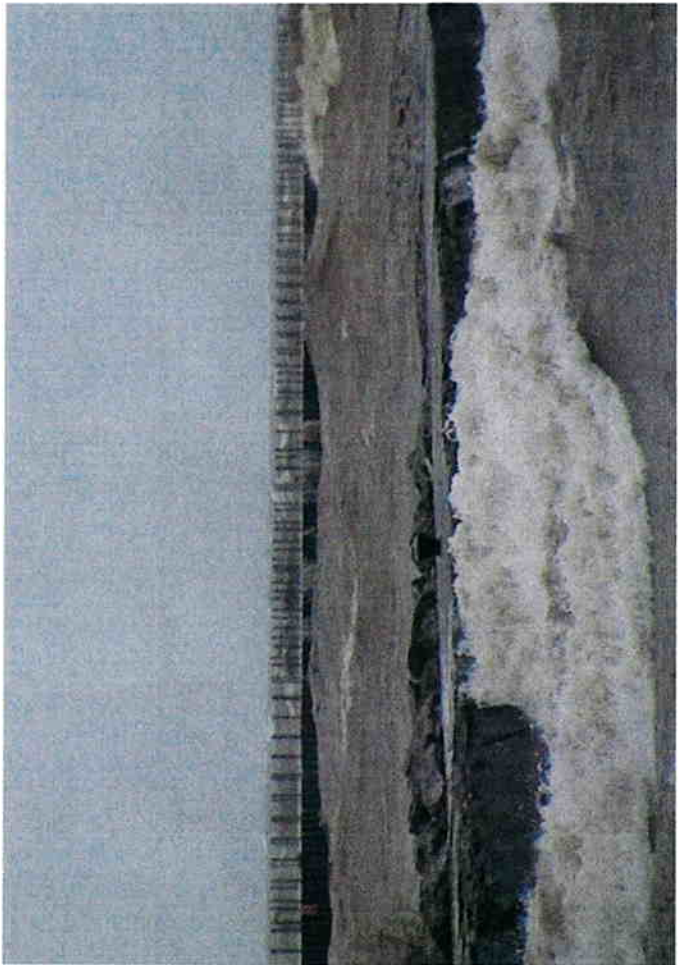

Rochester Harbor Photos - 02/06/08



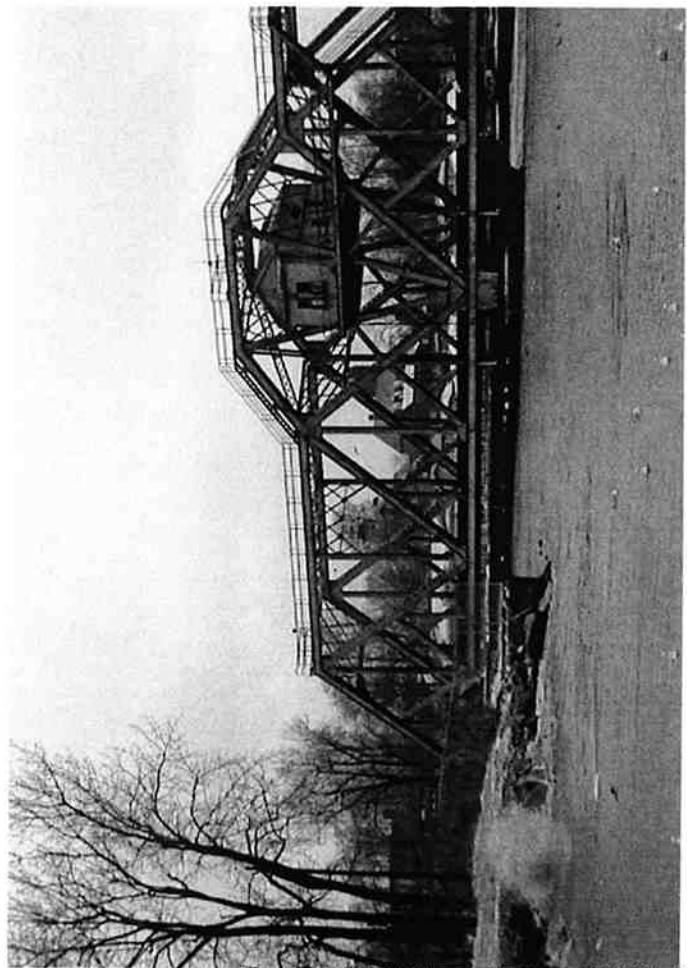
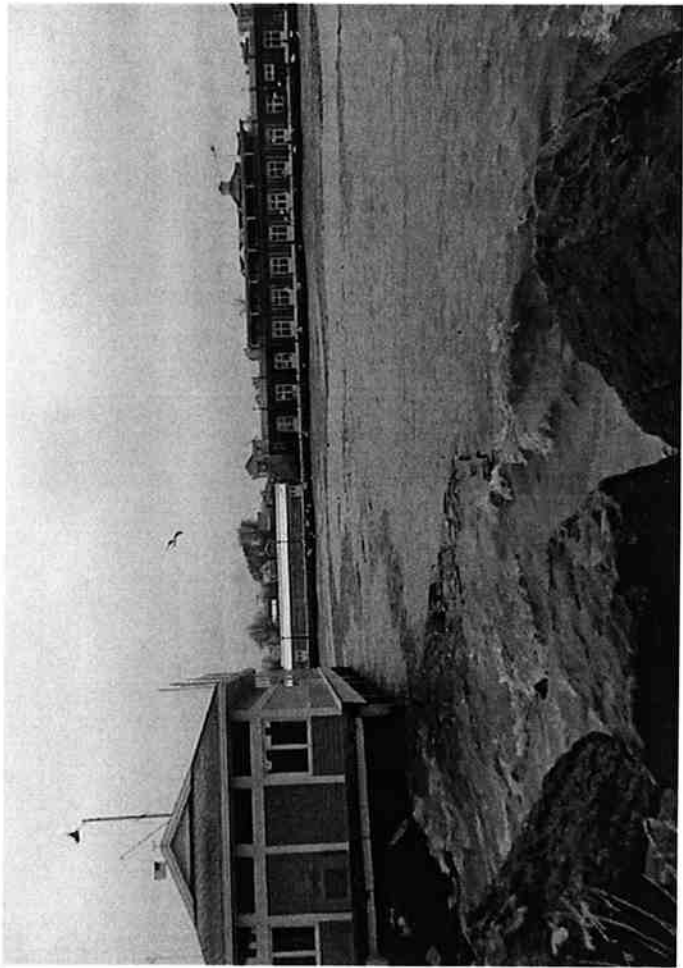

Rochester Harbor Photos - 02/06/08

VI. Entrance Design Options

A. Open Channel with Floating Wave Attenuators and Platform Baffle System.

The study team considered several marina entrances for the marina basin and have identified them as follows:

1. An initial considered entrance was north/upstream of the existing ferry terminal location. Based upon the observed and theoretical wave conditions, this entrance is not recommended as there will be unacceptable waves entering into the marina basin at that location.
2. The second marina location is upstream of the ferry terminal platform and adjacent to the Monroe County boat launch. This is the recommended entrance and should be lined with a stone revetment with wave attenuating devices, floating breakwater on the up and downstream sides of the ferry terminal structure in order to attenuate waves and surge as it moves upstream in the river and into the marina basin. It is further recommended that a baffle wall be constructed on the up and downstream sides of the ferry terminal platform in accordance with the exhibits attached hereto. It is anticipated that this combination baffle wall and floating wave attenuators will significantly reduce the wave energy through the ferry terminal structure which will reduce the maximum waves in the marina basin to a height of approximately 18" (or less) during most of the worst-predicted storms. These worst storms are anticipated to occur two to four times per year, as identified in the earlier wave study portion of the report.

B. Gated Channel

An alternative entrance would be to allow for future installation of a hydraulic gate that could entirely seal off the marina basin from the Genesee River mouth. This gate would eliminate waves during storms, however, would need to be manually operated, resulting in an annual operational cost, plus an additional installation cost, which is estimated at \$415,200.

It would be reasonable to recommend building the marina without the gate initially and verify the performance of the marina (without the gate) over the course of time. Thereafter, at a future date, the mechanical gate could be considered should conditions in the marina warrant additional investment in the entrance structure. It is noted that the entrance without the gate will provide better wave dynamic conditions than those experienced in both the Rochester Yacht Club and Shumway Marina locations due to the vertical walls within their marina basins and immediate exposure off the Rochester River without a significant acute-angle entrance configuration that reduces energy. Additionally, it is noted that the Rochester Yacht Club opening is approximately 150' versus the proposed opening at the marina access channel of 60', further preventing large waves from entering the marina.

It is further recommended that the interior basin also have floating wave attenuating-type dockage to further limit movement of docks and reduce wave energies inside the marina basin.

C. Cost of Mechanical Gate

The following is the estimated cost of installing a mechanical gate at the marina entrance:

Estimated Cost for Marina Gate	
	Cost
2 Gates @ 12,000 lbs. each @ \$4.00 per lb.	\$96,000
Hydraulic Control System Lump Sum	\$79,000
Quoin Gate Hanger Bearings - 2 @ \$6,000	\$12,000
Control Building with Electrical Power for Gates	\$15,000
Concrete Work - 230 c.y. @ \$300/c.y.	\$69,000
Dewatering - Lump Sum	\$50,000
Excavation & Backfill - Lump Sum	\$5,000
12 - 12" Pipe Piles - Furnished & Driven	\$20,000
Subtotal	\$346,000
Contingencies (10%)	\$34,600
Engineering (10%)	\$34,600
TOTAL	\$415,200



**Design and Construction
Of An Experimental Floating
Breakwater System**

By
James E. Muschell, PE
Senior Engineer
United Design Associates
Cheboygan, Michigan

University of Wisconsin
Floating Structures
Design Conference

June 12-14, 1991
Madison, Wisconsin

INTRODUCTION

There is a high demand for increased mooring of recreational craft in small harbors as more and more people recognize the attributes of water related recreation. As a matter of fact the development, construction, and expansion of berthing facilities and the manufacture of small recreational craft has become big business.

Since all of the easy small craft harbor facilities have already been constructed or are being renovated, the need for additional facilities has increased with the recreational boating demand. In conjunction with this demand for increased berthing space, environmental concerns have likewise developed with regards to harmful impacts on paths of migratory fish, fish habitat, littoral transport, and spawning grounds when rubble mound breakwaters or fixed structures are planned for the protection of newly proposed small craft harbors, and alternative solutions have been, and are being sought for prospective harbors.

HISTORICAL REVIEW

As a result of the boating recreational demand and the environmental concerns of rubble mound breakwaters, and interest in the use and development of floating breakwaters has been renewed. I use the word renewed because the present nomenclature for floating breakwaters apparently dates back to 1905 and laid dormant until World War II when the Bombardon was deployed in Europe. The Bombardon was not successful, and its failure was attributed to the collapse of the links between the units rather than the breaking of anchor lines or the failure of the structural body.

In 1957, the Naval Civil Engineering Laboratory began a concerted exploration of the existing knowledge of transportable units that could serve as breakwaters or piers. The results were summarized as TR 127 (1961) with a sequel report issued as TR 727 (1971) with the statement "Recurring efforts, spanning 125 years or more, have not produced a temporary breakwater easily transportable, effective over a broad range of wave conditions, and able to endure high seas." However, we should not give up simply because we have been unable to find as yet an effective solution. The conclusions of the report and our own experience indicates that locations for floating breakwaters are site specific, and of course, to be successful, must be designed for the seasonal fluctuations of boaters and limited to wave periods of approximately 4 to 6 seconds depending upon the economic considerations of both construction and maintenance.

BASIC PRINCIPLES OF FLOATING BREAKWATERS

The general function of a floating breakwater is to reduce wave heights and it does not change the wave length or period. On this basis the floating breakwater can be reasonably successful in reducing the problem of the incident wave heights by energy absorption, reflection, and turbulence. The design and construction of our experimental floating breakwater system is based upon a concept of water encapsulation in conjunction with a time rate release principle that absorbs wave energy and dissipates the wave crest during a time rate energy release cycle.

WAVE THEORY

In general, the actual water-wave phenomena are complex and difficult to describe mathematically, much less than to try to describe as yet the mathematics of the energy absorption of the time rate release principle of the encapsulation and release of water in this experimental system. The basic wave theory used to calculate the various wave characteristics for the four experimental floating breakwaters reported herein is the linear wave theory or small-amplitude wave theory, or the progressive wave theory developed by Airy. However, a review of Lambs (1945) Hydrodynamics and Wiegel's expansion and solutions thereof for the total energy of a wave per unit width of crest indicates that there is a need for a re-definition in the integral limits for floating structures, or for open piled structures for that matter since they consider the total depth of the water and not just the area impacted by the wave.

APPLICABILITY OF FLOATING BREAKWATER

Since the physical conditions of wind direction, wind stress, frequency, wave height, currents, and ice conditions are important factors in calculating the potential exposure conditions, it is important that as much historical weather data as possible be accumulated to make a valid engineering decision as to the design criteria that should be used in designing a floating breakwater.

An excellent source for surface winds is the U.S. Air Force Environmental Technical Application Center (USAFETAC) located in Asheville, North Carolina. The problem of seasonal fluctuations or seasonal periods, and the recurrence intervals of exposure is very important and the four experimental breakwaters which form the basis of this report were based upon the compilation and analysis of this data.

EXPERIMENTAL BREAKWATER CONCEPT

This experimental floating breakwater system was based in part on the literature, search, and discussion of floating breakwaters (Chen & Wiegel) based upon the concept of a large effective mass or moment of inertia resulting from "entrained water" might be more effective than other types. Field observations also verified previous laboratory testing that square cross sections give better wave reduction, and that entraining the water in relationship to the floatation pad so that two-thirds to full submergence of the structure seemed to work best.

DESIGN CONCEPT

The exploded view shows the open ends of the two lower chambers that are submerged directly beneath the flotation pod. From our observations this prototype floating breakwater suppresses or absorbs wave energy and reflects wave energy during the three major simultaneous dynamic oscillatory motions during periods of longitudinal pitch, rotation about the longitudinal axis, and vertical heaving because of the mass of inertia of the entrained water and its resistance to movement with accompanying turbulence and dissipation of orbital motion energy due to its restricted rate of release through the open end sections.

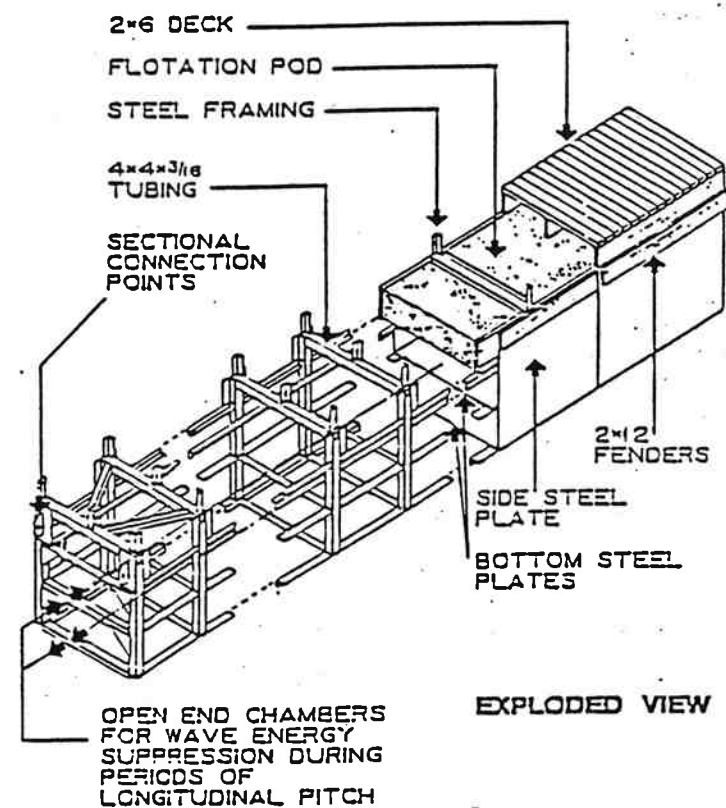

DESIGN CONCEPT (Continued)

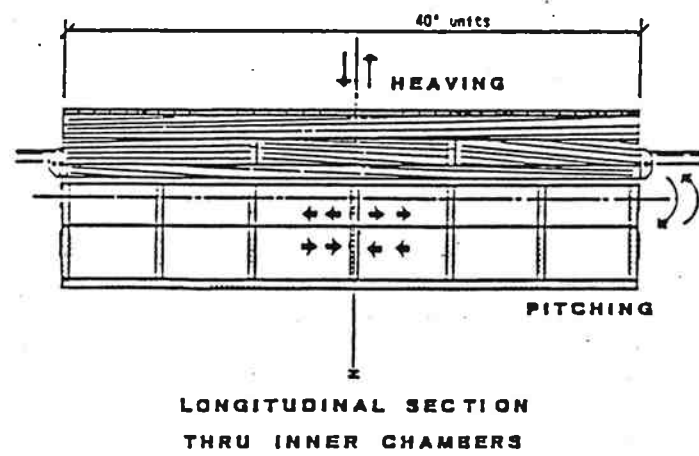
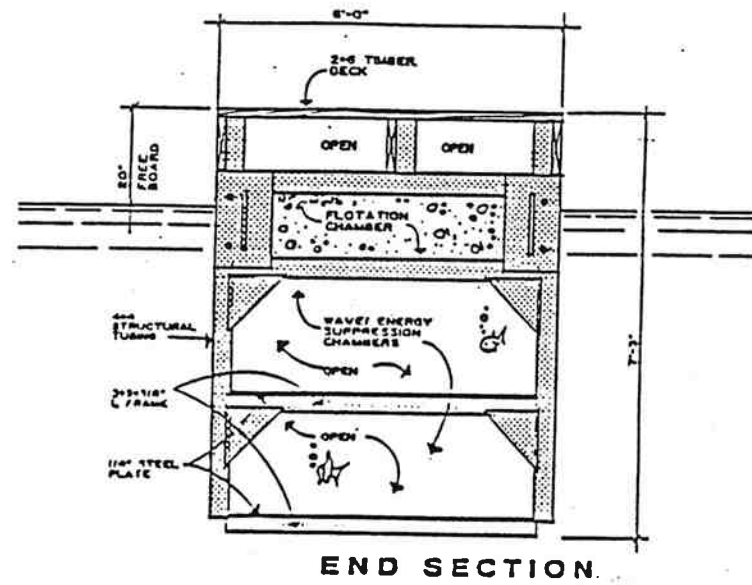

DESIGN CONCEPT (Continued)

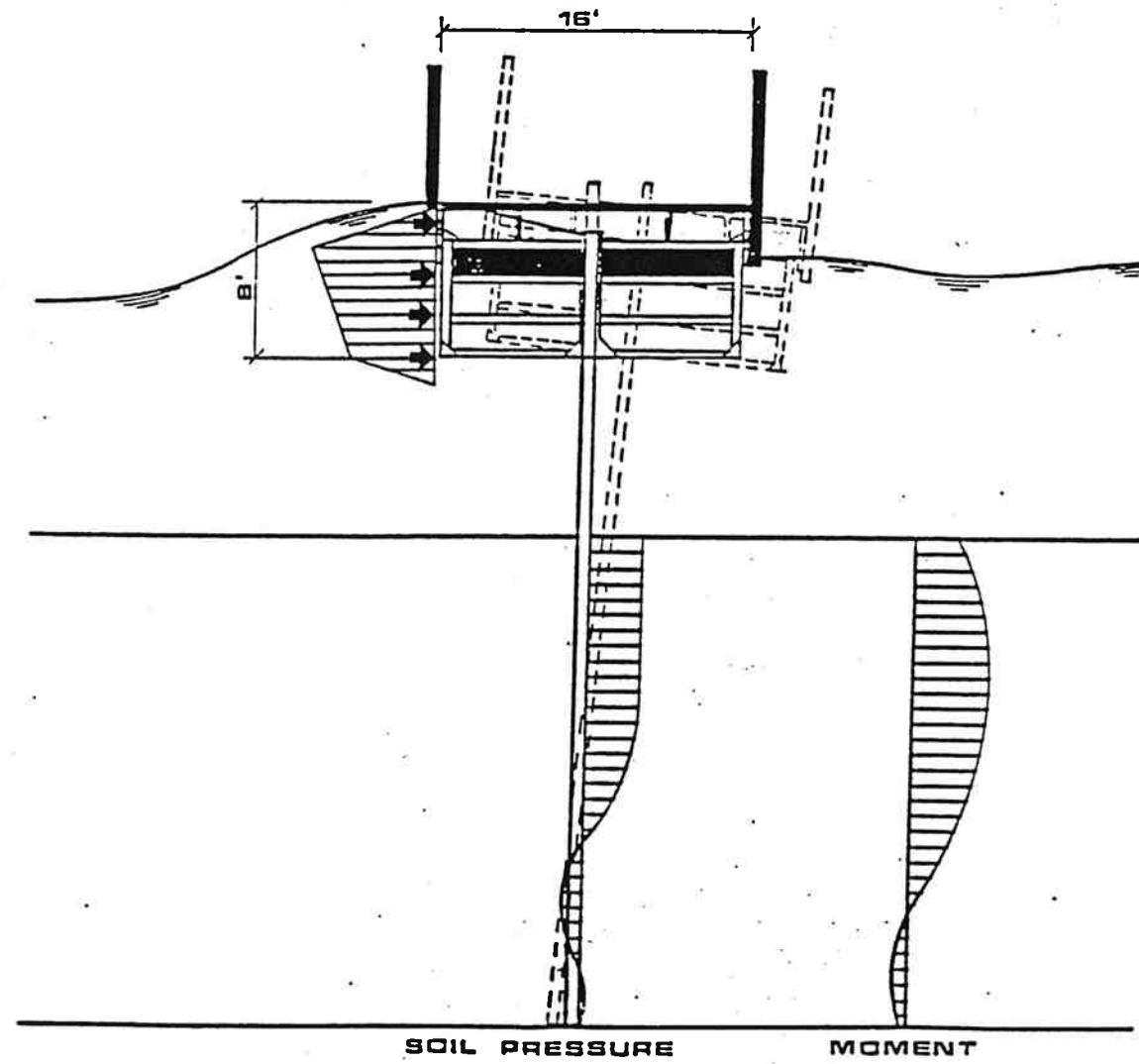

END SECTION

DESIGN CONCEPT (Continued)

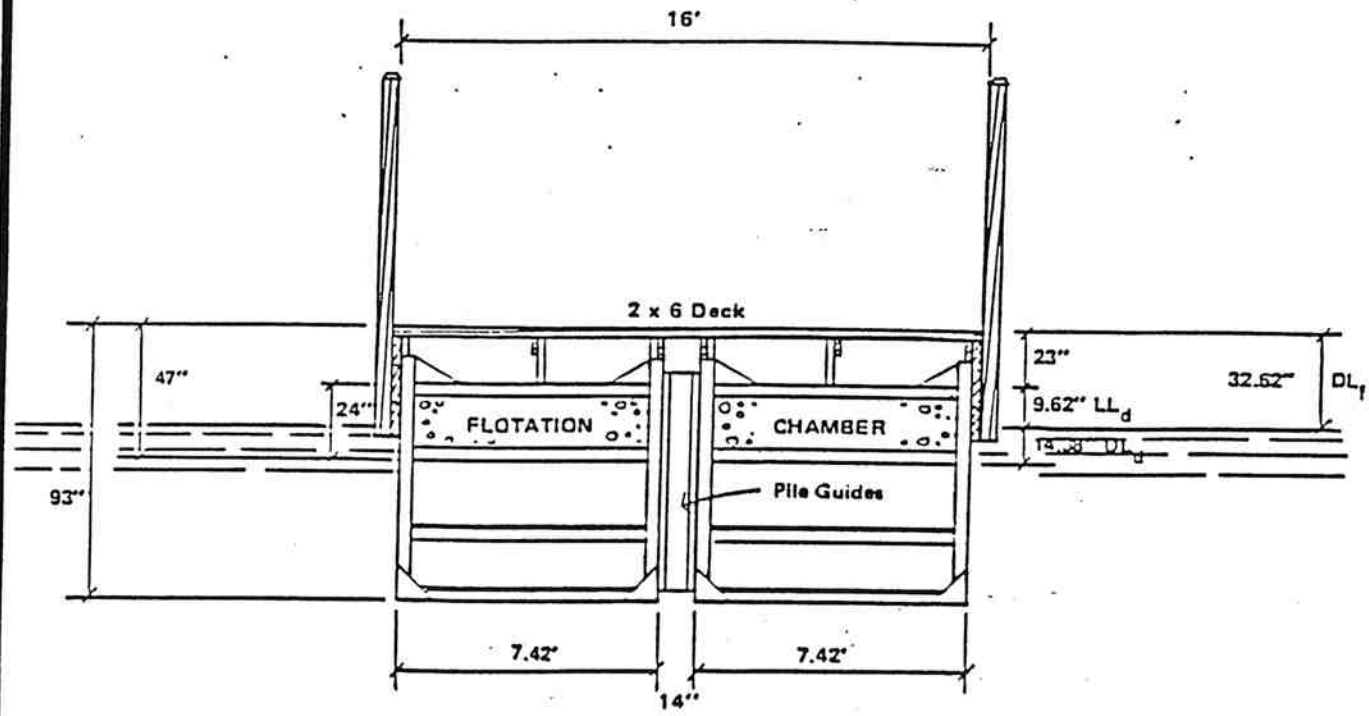

END SECTION

DESIGN CONCEPTS (Continued)

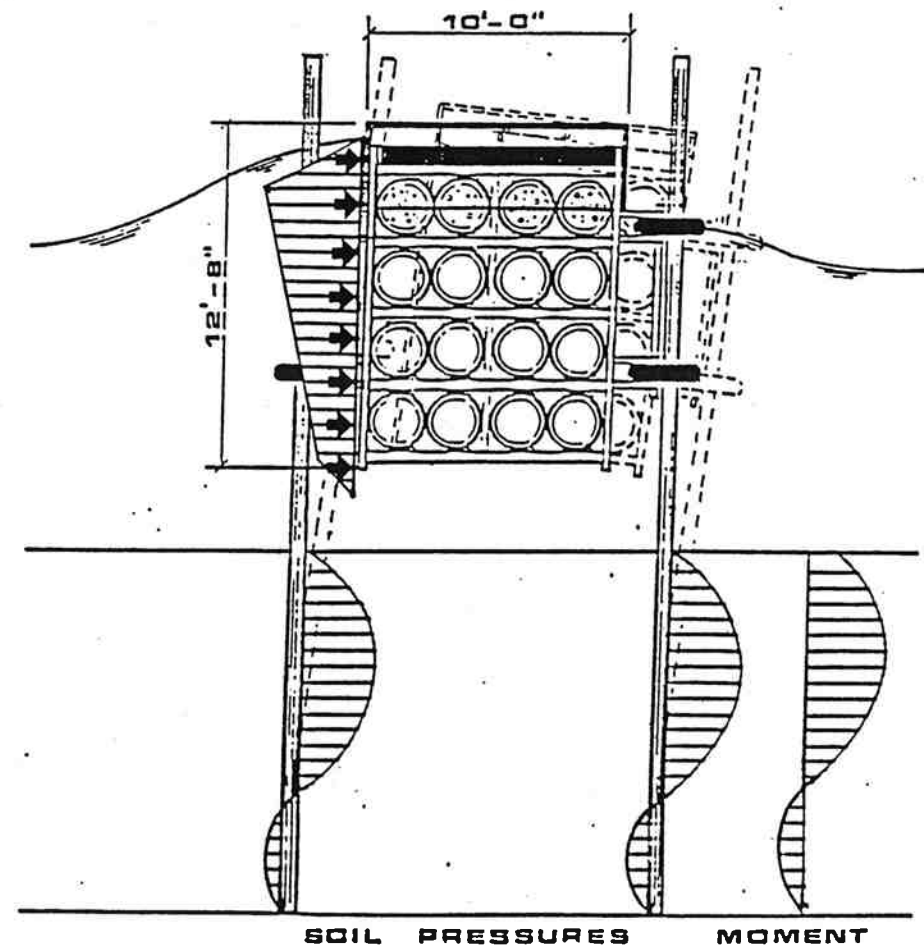

END SECTION

WAVE CHARACTERISTICS

The wave characteristics as used herein are based on the small amplitude wave theory and include the wave energy equations developed by Lamb (1945) with solutions as presented by Wiegel. The wave profiles submitted herein are only a fraction of the computer analysis made of varying wind stress intensities and directions, but are perhaps typical of some of the conditions and are by no means conclusive. A great deal of continued research and testing will be essential for the formulation of any specific recommendations for floating breakwaters of the type as presented herein. Although they have been successful to date as far as the clients have been concerned in view of the fact that some type of protection is better than none at all and much less costly than the conventional type of rubble mound breakwater or some other type of fixed structure. The general method of calculating the wave profiles used in this report are based upon the following equations of the Shore Protection Manual 1984 Volume I, Coastal Engineering Research Center.

SHALLOW WATER WAVE FORECASTING EQUATIONS:

$$\frac{gH}{U_A^2} = 0.283 \tanh \left[0.530 \left(\frac{gd}{U_A^2} \right)^{3/4} \right] \tanh \left\{ \frac{0.00565 \left(\frac{gF}{U_A^2} \right)^{1/2}}{\tanh \left[0.530 \left(\frac{gd}{U_A^2} \right)^{3/4} \right]} \right\} \quad (3-39)$$

$$\frac{gT}{U_A} = 7.54 \tanh \left[0.833 \left(\frac{gd}{U_A^2} \right)^{3/8} \right] \tanh \left\{ \frac{0.0379 \left(\frac{gF}{U_A^2} \right)^{1/3}}{\tanh \left[0.833 \left(\frac{gd}{U_A^2} \right)^{3/8} \right]} \right\} \quad (3-40)$$

$$\frac{g\tau}{U_A} = 5.37 \times 10^2 \left(\frac{gT}{U_A} \right)^{7/3} \quad (3-41)$$

$$L = \frac{gT^2}{2\pi} \tanh \left(\frac{2\pi d}{L} \right) \quad (2-4a)$$

WAVE CHARACTERISTICS (Continued)

Although these equations refer to forecasting for shallow water, the term "Shallow Water" as used therein is a relative expression for ocean depths up to 300 feet. Experience over the years has shown that these forecasting equations have performed well on the Great Lakes, and since there is no single theoretical development or presumably more accurate method for determining random wave fronts that are generated by winds blowing over relatively shallow water, these equations have been used. These equations are based on successive approximations in which wave energy is added due to wind stress and subtracted due to bottom friction and percolation. Modifications to the shallow water forecasting equations were made to provide a transition between the revised deepwater forecasting equations and the shallow water forecasting model. Research is underway that may revise the shallow water forecasting model and until the results of this new research are available it is the writers opinion that these equations should be used, at least, on the Great Lakes.

NOMENCLATURE (English Units)

U_A	=	Wind Stress (fps)	K_s	=	Shoaling Coefficient
d	=	Water depth (ft)	t	=	Time to generate wave (hrs)
F	=	Fetch (ft)	H_i	=	Incident Wave Height (ft)
T	=	Wave Period (Secs)	H_t	=	Transmitted wave Height (ft)
L	=	Wave Length (ft)	C_t	=	Coefficient of Transmission
C_t	=	$\frac{H_t}{H_i}$			

TYPICAL WAVE PROFILES

BOWERS HARBOR													
Azimuth	U _A	d	F	T	L	K _s	t	d/L	tanh (2 π d/L)	H _I	H _t	C _t	
204°	50	10	53,000	3.10	49.10	.9138	1.16	.2037	.8564	2.15	0.54	.25	
204°	50	20	53,000	3.34	57.15	.9617	1.38	.3499	.9757	2.71	0.68	.25	
BOYNE CITY													
Azimuth	U _A	d	F	T	L	K _s	t	d/L	tanh (2 π d/L)	H _I	H _t	C _t	
262°	82*	18	11,000	2.56	33.54	.9933	0.38	.5367	.9976	2.24	NA	NA	
288°	82*	18	18,800	2.98	45.57	.9738	0.55	.3950	.9861	2.80	NA	NA	
224°	48	18	5,000	1.69	14.69	.9999	0.30	1.2256	1.0000	0.95	0.29	0.31	
HARBOR SPRINGS													
Azimuth	U _A	d	F	T	L	K _s	t	d/L	tanh (2 π d/L)	H _I	H _t	C _t	
100°	58*	7	20,000	2.51	32.38	.9159	0.59	.2162	.8760	1.67	NA	NA	
110°	58*	7	18,000	2.45	30.79	.9187	0.55	.2274	.8914	1.62	NA	NA	
100°	58*	10	20,000	2.60	34.58	.9404	0.63	.2892	.9485	1.87	NA	NA	
110°	58*	10	18,000	2.53	32.77	.9464	0.59	.3052	.9577	1.81	NA	NA	

*Design criteria based on 11,000 daily observations at the azimuth shown



FLOATING
BREAKWATER

FETCH 83,000 FT
(25,314 M)

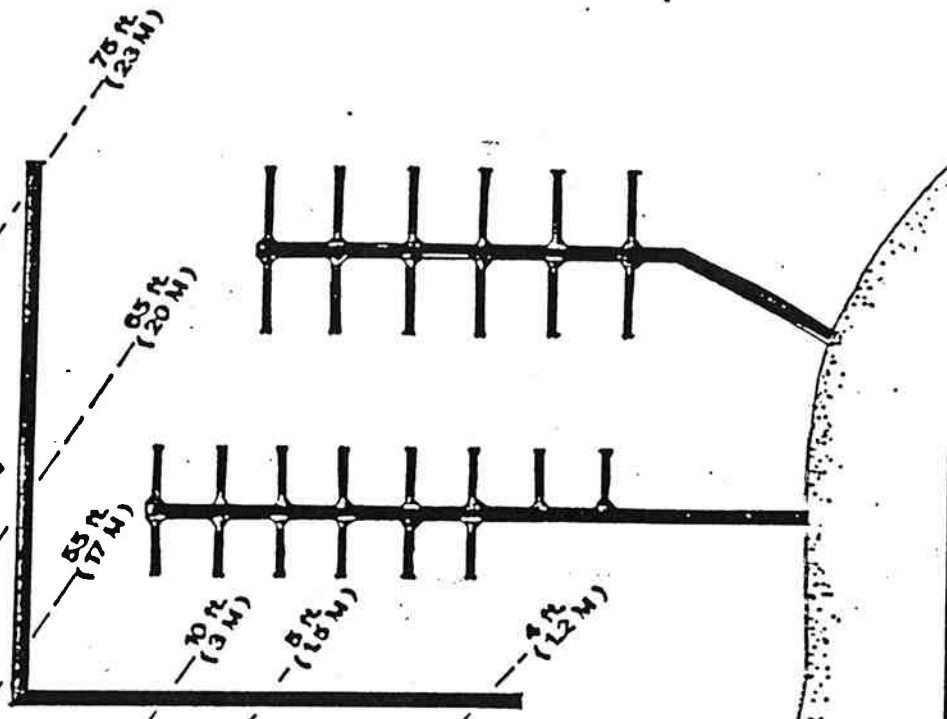

14 - 6' x 40' UNITS

BOYNE CITY

NORTH



PARK

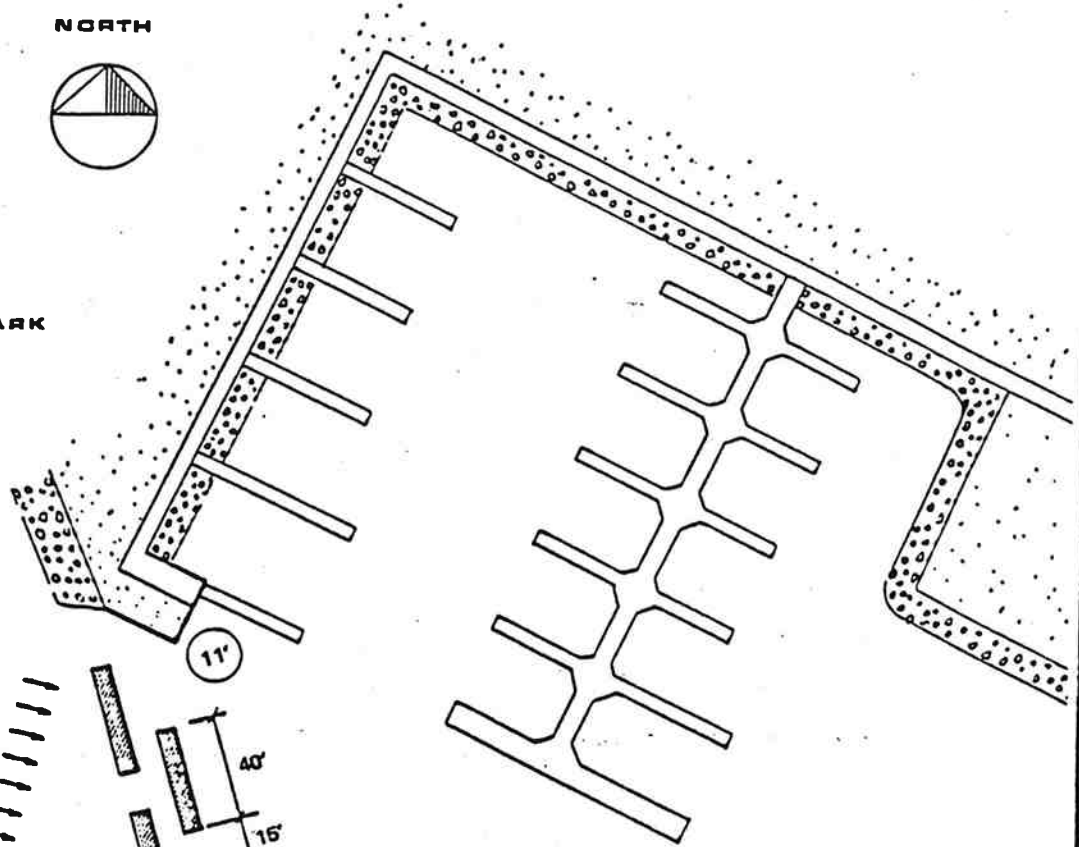

Azimuth 288°
Fetch 18,800'

Azimuth 262°
Fetch 11,000'

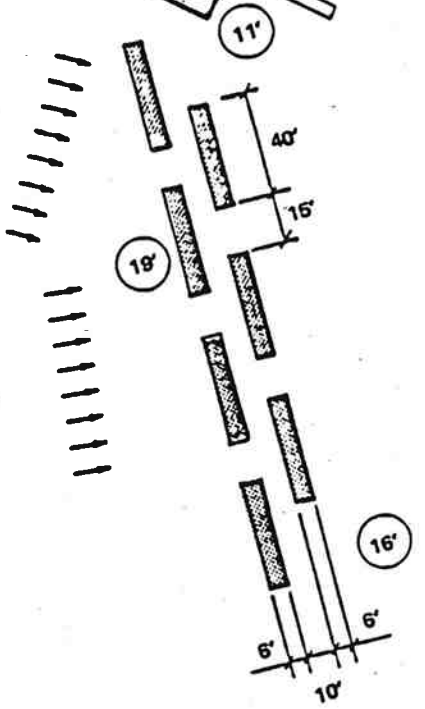

LAKE

CHARLEVOIX

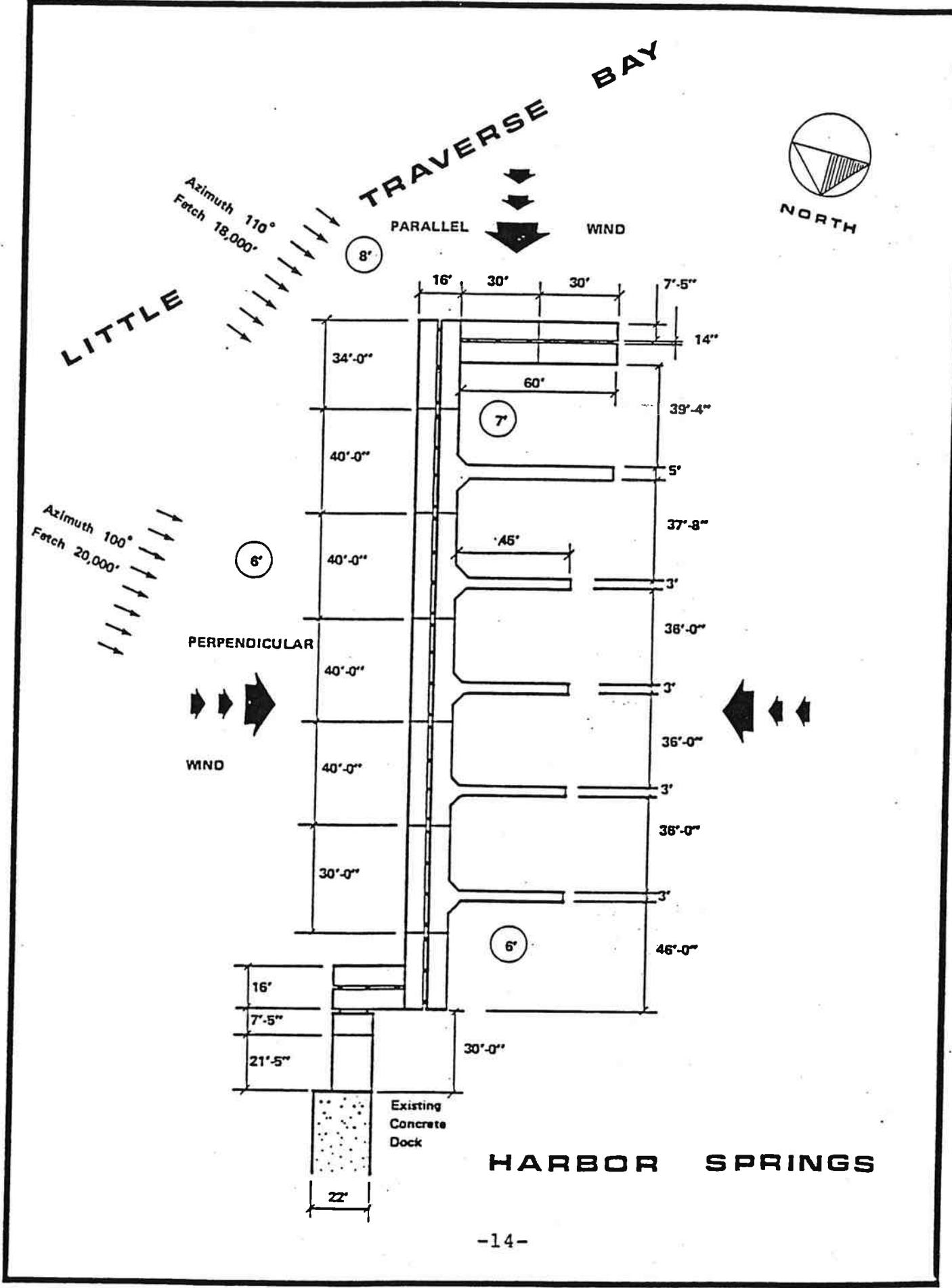

WAVE FORCES ON FLOATING BREAKWATERS

The determination of the wave forces exerted by waves on structures is difficult and in most cases semi-empirical methods have been taken from the treatment of standard hydraulic problems and adapted to the special conditions associated with wave motion. Regardless of the method of force prediction it is dependent upon the knowledge of water particle motion and empirically determined coefficients. The value of such coefficients need to be determined by measurement in conjunction with the theoretical values of fluid motion to more correctly predict particle motion. Therefore continued experimental research and actual measurement of numerous wave forces acting on floating structures under varying conditions need to be completed to determine what coefficients correctly calibrate the theoretical values of fluid motion with actual wave conditions.

In the meantime a review of Lambs (1945) theoretical development of the energy of surface waves per unit width of crest indicates that the total energy of a wave system is the sum of its kinetic energy and its potential energy or:

$$E = E_k + E_p$$

The kinetic energy is that part of the total energy due to water particle velocities associated with wave motion, and according to the Airy theory, if the potential energy is determined relative to the SWL and all waves are propagated in the same direction, potential and kinetic energy components are equal and therefore should generally be applicable to floating breakwaters during any one period of wind/wave intensity.

Or:
$$E_k = \int_0^L \int_0^{-d} \frac{\gamma}{2g} (u^2 + v^2) dy dx \quad (\text{Wiegel 2.60})$$

$$E_k = \int_0^L \int_0^{-d} \frac{\gamma}{2g} \left[\left(\frac{g a k \cosh k(y+d)}{\sigma \cosh kd} \cos(kx - \sigma t) \right)^2 + \left(\frac{g a k \sinh k(y+d)}{\sigma \cosh kd} \sin(kx - \sigma t) \right)^2 \right] dx dy$$

Letting:

$$E_t = 2E_k \quad \text{the foregoing equation may be written:}$$

$$E_t = 2 \int_0^L \int_0^{-d} \frac{\gamma}{2g} \left[\left(\frac{HgT \cosh [2\pi(z+d)/L]}{2L \cosh(2\pi d/L)} \cos\left(\frac{2\pi x}{L} - \frac{2\pi t}{T}\right) \right)^2 + \left(\frac{HgT \sinh [2\pi(z+d)/L]}{2L \cosh(2\pi d/L)} \sin\left(\frac{2\pi x}{L} - \frac{2\pi t}{T}\right) \right)^2 \right] dy dx$$

WAVE FORCES ON FLOATING BREAKWATERS (Continued)

The foregoing equations are based on a total depth (d) from the SWL to the bottom and with a floating structure the writer suggests that the above equations re-define the boundary limits by letting $d = SD$ (Structure Depth) - FB (Free Board) + an allowance for turbulence/shear as the remainder of the wave passes beneath the floating structure, and then solving the foregoing equation which uses the transitional water particle velocities for the horizontal component (u) and the vertical component (v) of the local fluid velocity.

In any event the total wave energy depending upon the structure depth, and water depth:

$$E_t \text{ should be } < \frac{\gamma H^2 L}{8}$$

The present methodology for determining wave forces on floating structures with depths below the incoming wave trough, is in the writers opinion, not very well defined as yet. Just what allowance or empirical coefficient should be made for turbulence/shear will depend upon additional basic research involving numerous field measurements under variable wave conditions.

Regardless of what wave forces actually occur on floating breakwaters, until a more accurate determination as to the effects of structure depth, turbulence/shear have been made and empirical coefficients determined, it would not seem prudent to attempt to mathematically describe how an unknown energy is absorbed by the floating breakwaters as presented herein.

CONCLUSIONS

The preliminary testing of the proto-type described herein although limited, is encouraging, and the gen-conclusions to date are:

1) There is a definite need for continued research and development of a floating breakwater concept for moderate wave periods and wave heights to lessen the environmental concerns with respect to littoral drift, habitat, paths for migrating fish, and restraint of water circulation.

2) The determination of the actual forces exerted by waves on floating breakwaters is difficult and to date is semi-empirical. Regardless of the method of force prediction it is dependent upon knowledge of water particle motion and empirically determined coefficients for floating structures/breakwaters with depths below the incoming wave trough. The value of such coefficients needs to be determined by field measurements in conjunction with the theoretical values of fluid motion.

3) Once the wave forces can be more accurately determined, basic research and analysis can be conducted towards mathematically describing the method of energy dissipation through absorption, reflection, and turbulence.

4) The foregoing types of breakwaters will in all probability be limited to wave periods of 4 to 6 seconds. Although once there is a better understanding of wave suppression, it is quite likely that new and more ambitious attempts will be made.

REFERENCES

- 1) Lamb (1945) Hydrodynamics, Dover Publications Inc., New York.
- 2) Wiegel (1964) Oceanographical Engineering, Prentice-Hall International Inc., London.
- 3) Kowalski, Editor (1974), Floating Breakwater Conference Papers, Sea Grant Ocean Engineering, University of Rhode Island, Marina Technical Report Series Number 24.
- 4) Kinsman (1984) Wind Waves, Dover Publications Inc., New York.
- 5) Chen and Wiegel (1970) Floating Breakwater for Reservoir Marinas, Proceedings, Twelfth Conference on Coastal Engineering, Washington, D.C.
- 6) Tsinker (1986) Floating Ports, Gulf Publishing Co., Houston, Texas.
- 7) Shore Protection Manuals (1984), Volumes I,II, Coastal Engineering Research Center, Department of the Army W.E.S. Vicksburg, Mississippi.

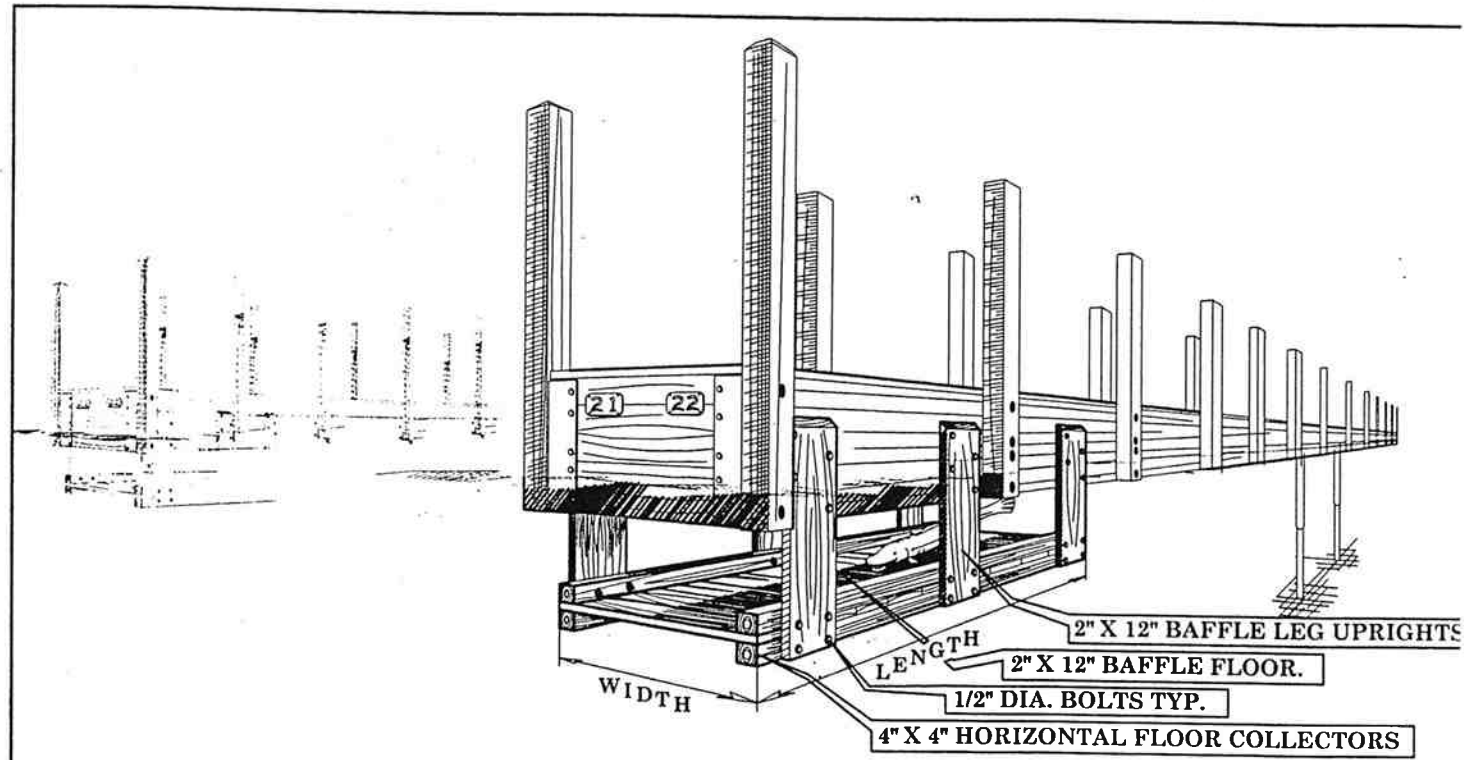

NOTE: SPANS OVER 8'-0" WILL USE 3" X 12" LUMBER FOR HORIZONTAL BAFFLE.

FLOTATION DOCKING SYSTEMS
of
CEDARVILLE MICHIGAN

BAFFLE

DETAIL #