



CITY OF ROCHESTER & MONROE COUNTY

APPENDICES

GREEN INFRASTRUCTURE RETROFIT MANUAL

Project Funded By
The National Oceanic and
Atmospheric Administration and
New York Sea Grant



CHERYL DINOLFO
COUNTY EXECUTIVE



City of Rochester, NY
Lovely A. Warren, Mayor
Rochester City Council

Prepared By Barton & Loguidice, DPC

APPENDICES

- 1. POLLUTANT REMOVAL EFFICIENCIES OF GREEN INFRASTRUCTURE PRACTICES**
- 2. INFILTRATION TESTING PROTOCOL**
- 3. SOIL MEDIA, TESTING AND AMENDMENT**
- 4. CONSTRUCTION INSPECTION FORMS**
- 5. OPERATION AND MAINTENANCE INSPECTION FORMS**
- 6. SAMPLE MAINTENANCE AGREEMENT**
- 7. CONSTRUCTION AND MAINTENANCE COSTS**
- 8. RECOMMENDED PLANTS FOR GI PRACTICES**
- 9. GREEN INFRASTRUCTURE FUNDING SOURCES**
- 10. SAMPLE PLANS, PROFILES & DETAILS**

APPENDIX 1

POLLUTANT REMOVAL EFFICIENCIES OF GREEN INFRASTRUCTURE PRACTICES

The stormwater field is continuously evolving as new technologies emerge and stormwater quality is acquired and evaluated. The NYS SMDM has a list of standard stormwater management practices that they have determined are capable of removing 80% total suspended solids (TSS) and 40% total phosphorus (TP) if designed, installed and maintained in accordance with the NYS SMDM. These standard practices include stormwater ponds, wetland, infiltration practices, filtering practices and open channel practices. Some of the GI practices included within this Retrofit Manual are considered standard practices within the NYS SMDM. This Retrofit Manual also includes additional GI practices that are not considered as standard practices in the NYS SMDM. Many of the GI practices listed within this Retrofit Manual can reduce total phosphorus loads, but not all. Some practices such as green roofs and bioretention practices, could actually contribute phosphorus to stormwater runoff. It should be noted that pollutant removal is not the only measurement for a well performing GI practice. These practices also offer runoff reduction, decreased thermal impacts, aesthetics and additional community benefits as presented in Section 2.3 of this Retrofit Manual. While many GI Practices can provide pollutant removal, the planning and design of specific GI practices should be carefully considered to ensure that the overall goals of the retrofit project are being achieved.

The following figures are excerpts from the December 2014 International Stormwater BMP Database Pollutant Category Statistical Summary Report <www.bmpdatabase.org> prepared by Geosyntec Consultants, Inc. and Wright Water Engineers, Inc. under support from Water Environment Research Foundation, Federal Highway Administration, Environment and Water Resources Institute of the American Society of Civil Engineers. The following illustrations are intended to provide some context of pollutant removal efficiencies for various GI Retrofit practices based on the data collected through www.bmpdatabase.org. The figures and tables present influent and effluent pollutant loads, along with the number of studies utilized to generate the data. The above referenced document and website should be referred to for additional information.

Total Suspended Solids

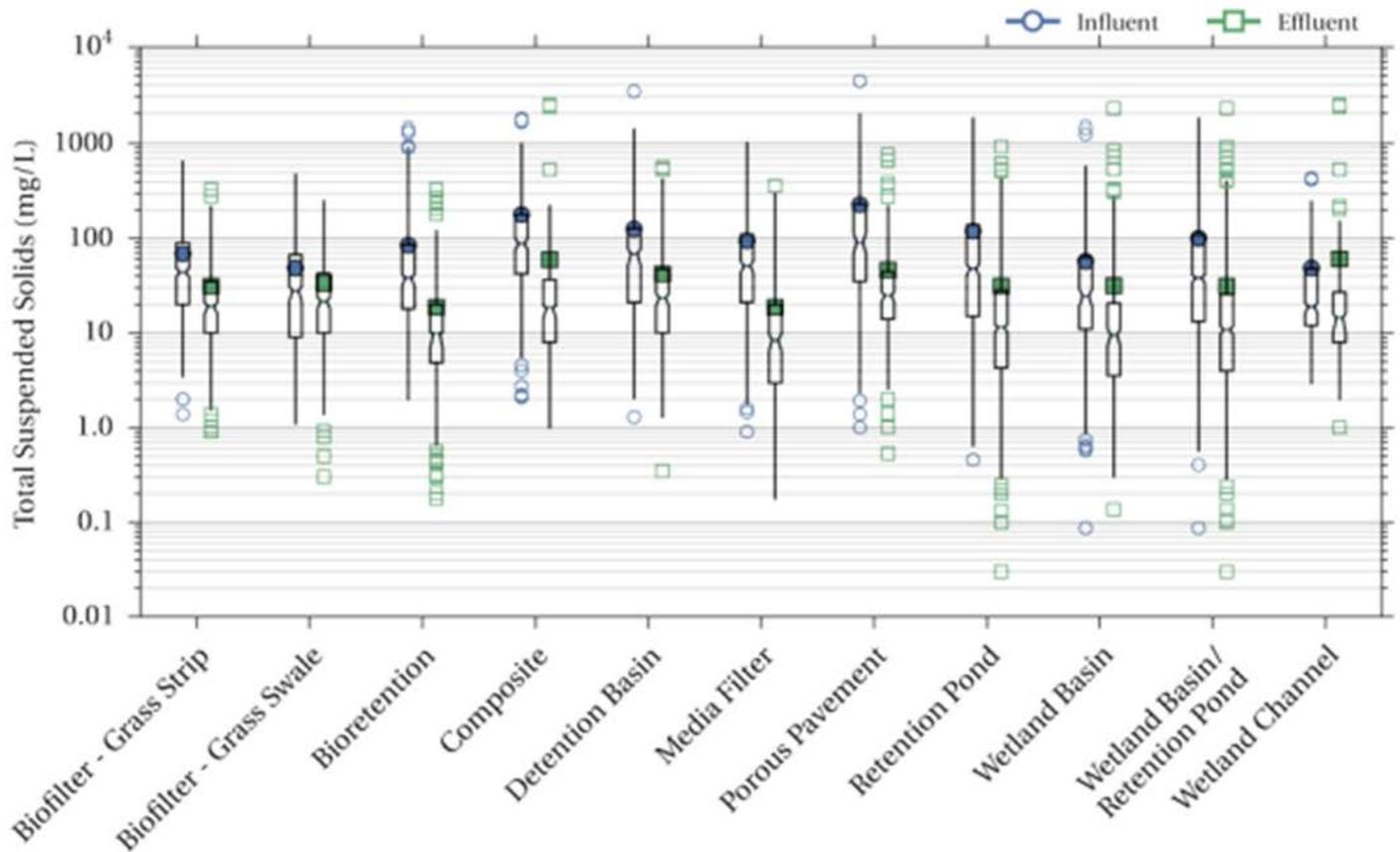

BMP Type	Count of Studies and EMCs		25th Percentile		Median (95% Conf. Interval)*		75th Percentile	
	In	Out	In	Out	In	Out	In	Out
Biofilter - Grass Strip	19; 361	19; 282	20.0	10.0	44.1 (39, 48)	19 (15.9, 21)**	90.0	35.0
Biofilter - Grass Swale	23; 399	23; 346	9.0	10.0	27.7 (21, 31.6)	21.6 (17.8, 24)**	67.0	43.0
Bioretention	22; 461	22; 393	18.0	4.9	38.1 (31, 42)	9.9 (7, 10)**	86.0	20.0
Composite	10; 202	10; 174	42.4	8.0	87.6 (75.1, 101.5)	18.4 (14, 19.3)**	178.8	36.5
Detention Basin	22; 321	22; 336	21.0	10.0	68.2 (52.3, 77.3)	23.3 (19.5, 26)**	128.0	47.0
Media Filter	23; 381	23; 358	21.1	3.0	50.9 (42.8, 58)	8.4 (6.3, 9.8)**	110.5	19.9
Porous Pavement	8; 356	8; 220	35.0	14.0	90.3 (69, 115)	24.9 (21.5, 27)**	230.0	44.4
Retention Pond	56; 923	56; 933	15.0	4.3	47.7 (40, 54)	11.5 (10, 12.3)**	139.8	28.0
Wetland Basin	19; 395	19; 385	11.0	3.5	24.5 (19.1, 28.9)	9.4 (7.4, 11)**	63.3	20.6
Wetland Basin/Retention Pond	75; 1318	75; 1318	13.3	4.0	37.9 (34, 41.6)	10.9 (9.6, 11.7)**	110.0	25.4
Wetland Channel	8; 171	8; 151	12.0	8.0	18.9 (16, 21)	14.4 (10, 16)**	47.5	27.0

NA – not available or less than 3 studies for BMP/constituent.

*Computed using the BCa bootstrap method described by Efron and Tibishirani (1993).

**Hypothesis testing in Attachment 1 shows statistically significant decreases for this BMP category.

APPENDIX 1

Bacteria: E.coli

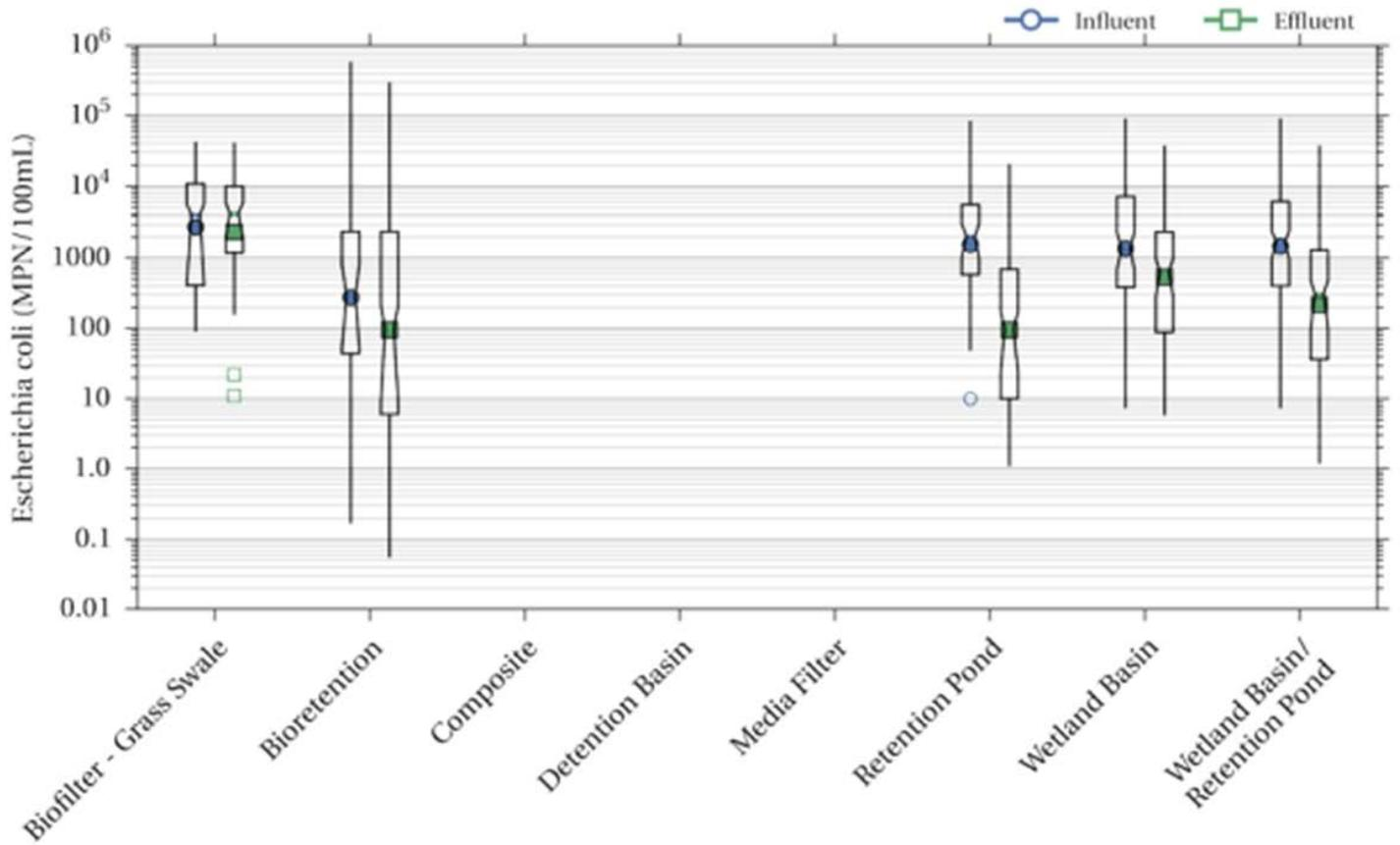

BMP Type	Count of Studies and EMCs		25th Percentile		Median (95% Conf. Interval)*		75th Percentile	
	In	Out	In	Out	In	Out	In	Out
Biofilter - Grass Strip	NA	NA	NA	NA	NA	NA	NA	NA
Biofilter - Grass Swale	5; 39	5; 39	411	1200	4010 (411, 5600)	4182 (1200, 5900)	11000	10000
Bioretention	4; 61	4; 61	44	6.0	290 (52, 820)	101 (9, 213)**	2400	2400
Composite	NA	NA	NA	NA	NA	NA	NA	NA
Detention Basin	NA	NA	NA	NA	NA	NA	NA	NA
Media Filter	NA	NA	NA	NA	NA	NA	NA	NA
Porous Pavement	NA	NA	NA	NA	NA	NA	NA	NA
Retention Pond	4; 69	4; 65	582	10	2063 (1000, 3106)	100 (24, 172)**	5500	697
Wetland Basin	5; 60	5; 59	383	88	1369 (694, 2336)	637 (279, 988)**	7169	2376
Wetland Basin/Retention Pond	9; 129	9; 124	403	36	1713 (988, 2433)	311 (100, 485)**	6100	1300
Wetland Channel	NA	NA	NA	NA	NA	NA	NA	NA

NA – not available or less than 3 studies for BMP/constituent.

*Computed using the BCa bootstrap method described by Efron and Tibishirani (1993).

**Hypothesis testing in Attachment 2 shows statistically significant decreases for this BMP category.

APPENDIX 1

Phosphorus

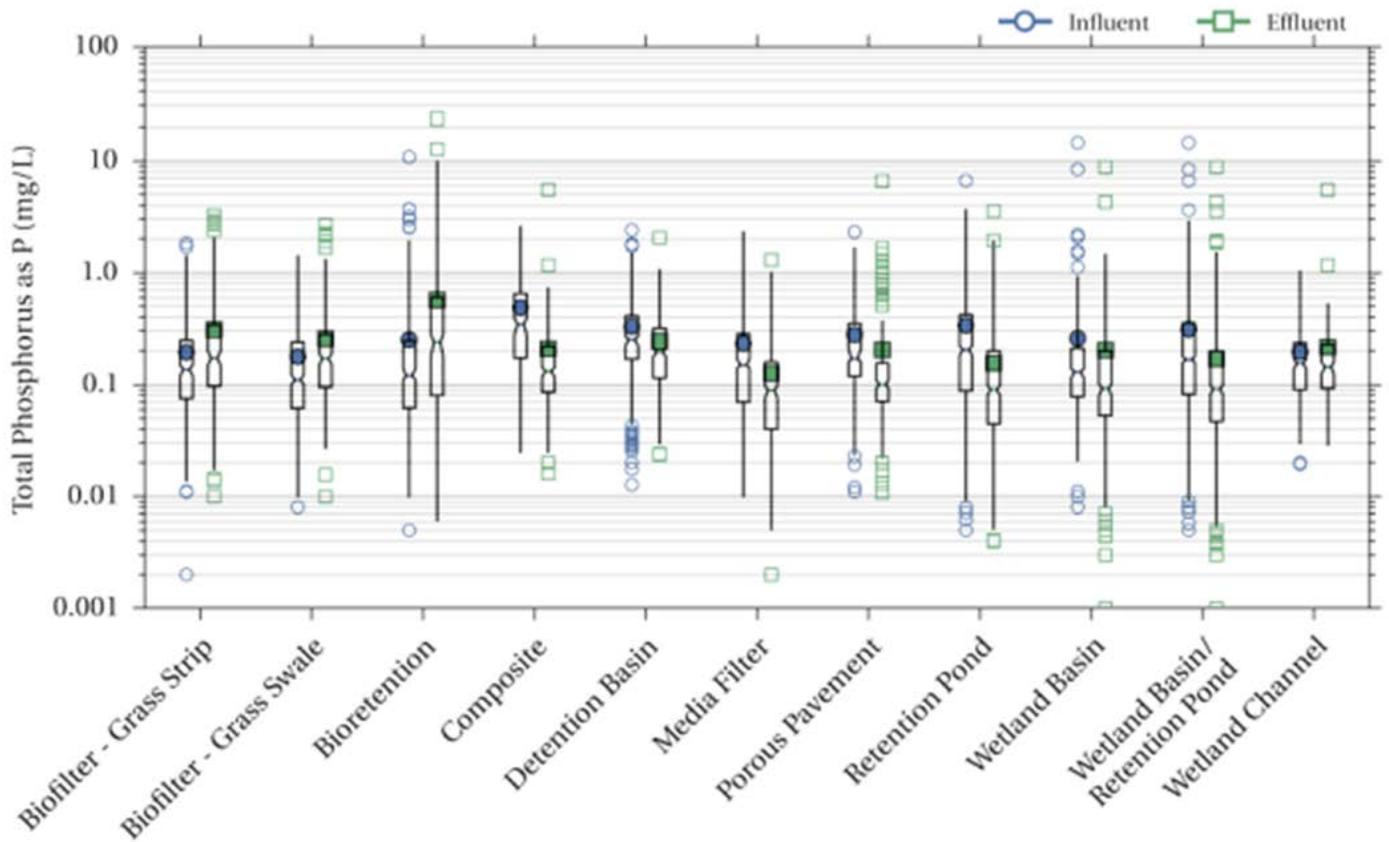

BMP Type	Count of Studies and EMCs		25th Percentile		Median (95% Conf. Interval)*		75th Percentile	
	In	Out	In	Out	In	Out	In	Out
Biofilter - Grass Strip	19; 360	19; 276	0.075	0.097	0.137 (0.120, 0.150)	0.173 (0.150, 0.199)***	0.249	0.339
Biofilter - Grass Swale	22; 393	22; 341	0.062	0.095	0.110 (0.100, 0.124)	0.171 (0.150, 0.190)***	0.240	0.280
Bioretention	27; 515	27; 435	0.062	0.080	0.120 (0.110, 0.140)	0.240 (0.183, 0.280)***	0.246	0.600
Composite	10; 184	10; 166	0.173	0.086	0.344 (0.276, 0.397)	0.132 (0.116, 0.144)**	0.650	0.219
Detention Basin	21; 307	21; 322	0.169	0.114	0.253 (0.224, 0.27)	0.197 (0.178, 0.213)**	0.410	0.319
Media Filter	22; 365	22; 349	0.070	0.040	0.150 (0.140, 0.170)	0.089 (0.075, 0.097)**	0.283	0.160
Porous Pavement	7; 325	7; 192	0.119	0.071	0.176 (0.150, 0.178)	0.100 (0.093, 0.110)**	0.350	0.155
Retention Pond	54; 874	54; 867	0.088	0.045	0.206 (0.184, 0.224)	0.091 (0.08, 0.099)**	0.421	0.200
Wetland Basin	17; 376	17; 369	0.078	0.053	0.130 (0.115, 0.138)	0.093 (0.080, 0.100)**	0.212	0.200
Wetland Basin/Retention Pond	71; 1250	71; 1236	0.082	0.047	0.168 (0.157, 0.18)	0.091 (0.082, 0.098)**	0.354	0.200
Wetland Channel	8; 165	8; 146	0.090	0.093	0.156 (0.138, 0.170)	0.144 (0.122, 0.160)	0.238	0.229

*Computed using the BCa bootstrap method described by Efron and Tibishirani (1993).

**Hypothesis testing in Attachment 4 shows statistically significant decreases for this BMP category.

***Hypothesis testing in Attachment 4 shows statistically significant *increases* for this BMP category.

APPENDIX 1

Pollutant Removal Efficiencies of
Green Infrastructure Practices

APPENDIX 2

INFILTRATION TESTING PROTOCOL

The following is the Infiltration Testing Protocol included in the NYS SMDM.

General Notes Pertinent to All Testing

1. For infiltration practices, a minimum field infiltration rate (f_c) of 0.5 inches per hour is required; areas yielding a lower rate preclude these practices. If the minimum f_c exceeds two inches per hour, half of the WQ_v must be treated by an upstream SMP that does allow infiltration. For F-1 and F-6 practices, no minimum infiltration rate is required if these facilities are designed with a “day-lighting” underdrain system; otherwise these facilities require a 0.5 inch per hour rate.
2. Number of required borings is based on the size of the proposed facility. Testing is done in two phases, (1) Initial Feasibility, and (2) Concept Design Testing.
3. Testing is to be conducted by a qualified professional. This professional shall either be a registered professional engineer in the State of New York, a soils scientist or geologist also licensed in the State of New York.

Initial Feasibility Testing

Feasibility testing is conducted to determine whether full-scale testing is necessary, and is meant to screen unsuitable sites, and reduce testing costs. A soil boring is not required at this stage. However, a designer or landowner may opt to engage Concept Design Borings per Table H-1 at his or her discretion, without feasibility testing.

Initial testing involves either one field test per facility, regardless of type or size, or previous testing data, such as the following:

- * septic percolation testing on-site, within 200 feet of the proposed SMP location, and on the same contour [can establish initial rate, water table and/or depth to bedrock]
- * previous written geotechnical reporting on the site location as prepared by a qualified geotechnical consultant
- * NRCS County Soil Mapping *showing an unsuitable soil group* such as a hydrologic group “D” soil in a low-lying area, or a Marlboro Clay

If the results of initial feasibility testing as determined by a qualified professional show that an infiltration rate of greater than 0.5 inches per hour is probable, then the number of *concept design test* pits shall be per the following table. An encased soil boring may be substituted for a test pit, if desired.

Table D-1 Infiltration Testing Summary Table

Type of Facility	Initial Feasibility Testing	Concept Design Testing (initial testing yields a rate greater than 0.5"/hr)	Concept Design Testing (initial testing yields a rate lower than 0.5"/hr)
I-1 (trench)	1 field percolation test, test pit not required	1 infiltration test and 1 test pit per 50' of trench	not acceptable practice
I-2 (basin)	1 field percolation test, test pit not required	1 infiltration test* and 1 test pit per 200 sf of basin area	not acceptable practice
F-1 (sand filter)	1 field percolation test, test pit not required	1 infiltration test and 1 test pit per 200 sf of filter area (no underdrains required**)	underdrains required
F-6 (bioretention)	1 field percolation test, test pit not required	1 infiltration test and 1 test pit per 200 sf of filter area (no underdrains required**)	underdrains required

*feasibility test information already counts for one test location

** underdrain installation still strongly suggested

Documentation

Infiltration testing data shall be documented, which shall also include a description of the infiltration testing method, if completed. This is to ensure that the tester understands the procedure.

Test Pit/Boring Requirements

- a. excavate a test pit or dig a standard soil boring to a minimum depth of 4 feet below the proposed facility bottom elevation
- b. determine depth to groundwater table (if within 4 feet of proposed bottom) upon initial digging or drilling, and again 24 hours later
- c. conduct Standard Penetration Testing (SPT) every 2' to a depth of 4 feet below the facility bottom
- d. determine USDA or Unified Soil Classification System textures at the proposed bottom and 4 feet below the bottom of the SMP
- e. determine depth to bedrock (if within 4 feet of proposed bottom)
- f. The soil description should include all soil horizons.
- g. The location of the test pit or boring shall correspond to the SMP location; test pit/soil boring stakes are to be left in the field for inspection purposes and shall be clearly labeled as such.

Infiltration Testing Requirements

- a. Install casing (solid 4-6 inch diameter, 30" length) to 24" below proposed SMP bottom (see Figure D-1).

- b. Remove any smeared soiled surfaces and provide a natural soil interface into which water may percolate. Remove all loose material from the casing. Upon the tester's discretion, a two (2) inch layer of coarse sand or fine gravel may be placed to protect the bottom from scouring and sediment. Fill casing with *clean* water to a depth of 24" and allow to pre-soak for twenty-four hours
- c. Twenty-four hours later, refill casing with another 24" of clean water and monitor water level (measured drop from the top of the casing) for 1 hour. Repeat this procedure (filling the casing each time) three additional times, for a total of four observations. Upon the tester's discretion, the final field rate may either be the average of the four observations, or the value of the last observation. The final rate shall be reported in *inches per hour*.
- d. May be done though a boring or open excavation.
- e. The location of the test shall correspond to the SMP location.
- f. Upon completion of the testing, the casings shall be immediately pulled, and the test pit shall be back-filled.

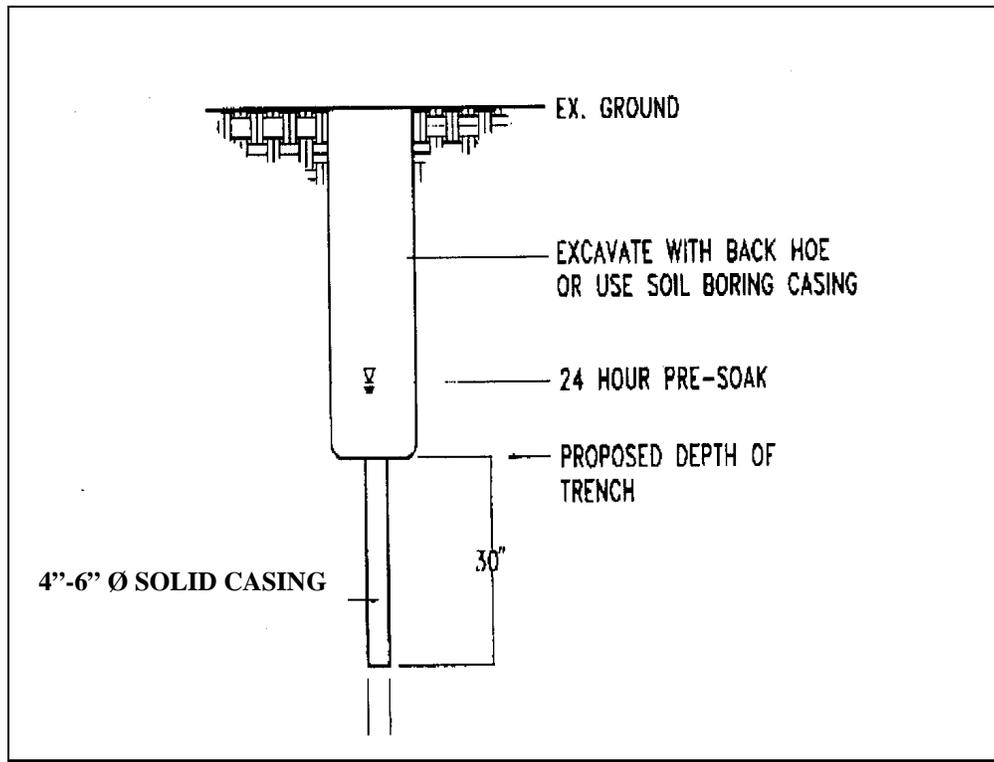
Figure D.1 Infiltration Testing Requirements**Laboratory Testing**

- a. Grain-size sieve analysis and hydrometer tests where appropriate may be used to determine USDA soils classification and textural analysis. Visual field inspection by a qualified professional may also be used, provided it is documented. *The use of lab testing to establish infiltration rates is prohibited.*

Bioretention Testing

All areas to be used as bioretention facilities shall be back-filled with a suitable sandy loam planting media. The borrow source of this media, which may be the same or different location from the bioretention area itself, must be tested as follows:

If the borrow area is virgin, undisturbed soil, one test is required per 200 sf of borrow area; the test consists of “grab” samples at one foot depth intervals to the bottom of the borrow area. All samples at the testing location are then mixed, and the resulting sample is then lab-tested to meet the following criteria:

- a) USDA minimum textural analysis requirements: A textural analysis is required from the site stockpiled topsoil. If topsoil is imported, then a texture analysis shall be performed for each location where the top soil was excavated.

Minimum requirements:

sand	35 - 60%
silt	30 - 55%
clay	10 - 25%

- b) The soil shall be a uniform mix, free of stones, stumps, roots or other similar objects larger than two inches.
- c) Consult the bioretention construction specifications (Appendix J) for further guidance on preparing the soil for a bioretention area.

APPENDIX 3

SOIL MEDIA, TESTING AND AMENDMENT

The following are soil specifications designed by the University of New Hampshire Stormwater Center. The UNH Stormwater Center conducts independent research on stormwater management technologies, with a focus on cold climate performance.

These specifications include:

- Definition of Terms
- Pre-amendment Soil Media Requirements
- Testing Requirements
- Amendment Requirements
- Construction and Soil Protection Requirements

Soil media characteristics are summarized below. Further details are included in the UNH Stormwater Center Bioretention Soil Specification on the following page.

Particle Size Distribution by Separates:

- Material > 4.76 mm = 0%
- Very Course Sand/Gravel (2.0-4.76 mm) = 0-5%
- Sand (0.42-2.0 mm) = 60-85 %
- Silt (0.074-0.42 mm) < 20%
- Clay (< 0.074 mm) < 5%

Soil Property Requirements

- Sticks and Roots should be minimized, preferably eliminated
- Debris and Other Foreign Materials: should be minimized
- Organic matter = 3-8%
- pH = 6-7
- CEC of Total Soil = Minimum 10 meq/100mL at pH of 7.0
- Soil Infiltration Rate: Minimum 8"/hour. Preferably 20-30"/hour

Note: The New York State Nutrient Runoff Law Prohibits using fertilizers that include phosphorus to fertilize lawns unless a soil test indicates a need for phosphorus or the lawn is newly established. This requirement does not apply to garden or tree plantings. See <http://www.dec.ny.gov/chemical/67239.html> for more information.

SOIL PREPARATION (PERFORMANCE SPECIFICATION) for Bioretention Systems

PART 1 - GENERAL

1.1 SUMMARY

- A. Section includes soil media for the bioretention system specified according to performance requirements of the mixes. In general the media is suitable for a variety of plant species however careful consideration of system hydrology and solar radiation should be included in plant selection.

1.2 ALLOWANCES

- A. Preconstruction and field quality-control testing are part of testing and inspecting allowance.

1.3 DEFINITIONS

- A. Bioretention Soil Mix (BSM): Existing, on-site soil; imported soil; or manufactured soil that has been modified as specified with soil amendments. A soil mixture best for media filtration.
- B. Cation exchange capacity (CEC): a measure of the soil's ability to hold positively charged ions
Organic Matter: The total organic materials in soil and the soil biomass; also called "humus" or "soil organic matter."
- C. Subgrade: Surface and/or elevation of subsoil remaining after excavation is complete, or the top surface of a fill or backfill above which a bioretention system is constructed.

1.4 PREINSTALLATION MEETINGS

- A. Pre-installation Conference: Conduct conference at **the Project site prior to commencement of construction activities**

1.5 ACTION SUBMITTALS

- A. Product Data: For each type of product.
 - 1. Include recommendations for application and use.
 - 2. Include test data substantiating that products comply with requirements.
 - 3. Include sieve analyses for aggregate materials.
 - 4. Material Certificates: For each type of imported soil, soil amendment and/or fertilizer, before delivery to the site, according to the following:
 - a. Manufacturer's qualified testing agency's certified analysis of standard products.
 - b. Analysis of nonstandard materials, by a qualified testing agency.

1.6 INFORMATIONAL SUBMITTALS

- A. Qualification Data: For each testing agency.
- B. Preconstruction Test Reports: For preconstruction soil analyses specified in "Preconstruction Testing" Article.
- C. Field quality-control reports.

1.7 QUALITY ASSURANCE

- A. Testing Agency Qualifications: An independent, state-operated, or university-operated laboratory; experienced in soil science, soil testing, and plant nutrition; with the experience and capability to conduct the testing indicated; and that specializes in types of tests to be performed.
 - 1. Laboratories: Subject to compliance with requirements.

1.8 TESTING REQUIREMENTS

- A. General: Perform tests on soil samples according to requirements in this article.
- B. Physical Testing:
 - 1. Soil samples must be obtained during the soil characterization field analysis and classified according to ASTM D2487 (Standard Practice for Classification of Soils for Engineering Purposes [Unified Soil Classification System]) and ASTM D2488 (Standard Practice for Description and Identification of Soils [Visual-Manual Procedure]).
 - 2. Soil samples must undergo laboratory particle size analysis according to ASTM D422 (Standard Test Method for Particle-Size Analysis of Soils).
 - 3. Saturated Hydraulic Conductivity: Using ASTM D5084-10 Standard Test Methods for Measurement of Hydraulic Conductivity of Saturated Porous Materials Using a Flexible Wall Permeameter at 85 percent compaction according to ASTM D 698 (Standard Proctor).
- C. Chemical Testing:
 - 1. Cation Exchange Capacity (CEC): Analysis by sodium saturation at pH 7
- D. Fertility Testing: Soil fertility analysis according to standard laboratory protocols including the following:
 - 1. Percentage of organic matter.
 - 2. CEC, calcium percent of CEC, and magnesium percent of CEC.
 - 3. Soil reaction (acidity/alkalinity pH value).
 - 4. Nitrogen ppm.
 - 5. Phosphorous ppm.
 - 6. Copper ppm.
- E. Organic-Matter Content: Using ASTM D 2974-00 Standard Test Methods for Moisture, Ash, and Organic Matter of Peat and Other Organic Soils. Analysis using loss-by-ignition method.

1.9 DELIVERY, STORAGE, AND HANDLING

- A. Packaged Materials: Deliver packaged materials in original, unopened containers showing weight, certified analysis, name and address of manufacturer, and compliance with state and Federal laws if applicable.
- B. Bulk Materials:

1. Do not dump or store bulk materials near structures, utilities, walkways and pavements, or on existing turf areas or plants.
2. Provide erosion-control measures to prevent erosion or displacement of bulk materials, discharge of soil-bearing water runoff, and airborne dust reaching adjacent properties, water conveyance systems, or walkways.
3. Do not move or handle materials when they are wet or frozen.

PART 2 - PRODUCTS

2.1 SOIL MEDIA SPECIFIED ACCORDING TO PERFORMANCE REQUIREMENTS

Particle Size Distribution according to ASTM D422 (Standard Test Method for Particle-Size Analysis of Soils).

1. Particle Size Distribution by Separates:
 - a. Exclude any material > 4.76 mm - 0%
 - b. Very Coarse Sand/Gravel: Gravel (2.0 to 4.76 mm) 5% maximum (percent by dry weight).
 - c. Sand (0.42 to 2.0 mm) 60 - 85% (percent by dry weight).
 - d. Silt (0.074 to 0.42 mm) 20% maximum (percent by dry weight).
 - e. Clay (less than 0.074mm) 5% maximum (percent by dry weight).

Table 1: Acceptable particle size distribution of final bioretention soil mix

Sieve #	Sieve Size in (mm)	% Passing
4	0.187 (4.76)	100
10	0.079 (2)	95
40	0.017 (0.42)	40
200	0.003 (0.075)	20
>200	0.001 >(0.075)	5

2. Fragment Size Distribution:
 - a. Sticks and Roots: should be minimized and preferably eliminated
 - b. Debris and Other Foreign Materials: should be minimized
3. Percentage of Organic Matter: Minimum 3 percent by volume and maximum 8 percent by volume.
4. Soil Reaction: pH of 6 to 7.
5. CEC of Total Soil: Minimum 10 meq/100 mL at pH of 7.0.
6. Soil infiltration rate: Minimum 8 inches per hour (preferably in the range of 20-30 in/hr providing a 3 x factor of safety to account for aging and surface clogging).
7. Basis-of-Design Product: Subject to compliance with requirements indicated on Drawings
8. Basic Properties: Manufactured soil **SHALL NOT** contain the following:
 - a. Unacceptable Materials: Concrete slurry, concrete layers or chunks, cement, plaster, building debris, asphalt, bricks, oils, gasoline, diesel fuel, paint thinner, turpentine, tar, roofing compound, acid, solid waste, and other extraneous materials that are harmful to plant growth.

- b. Unsuitable Materials: Stones, roots, plants, sod, clay lumps, and pockets of coarse sand that exceed a combined maximum of 5 percent by dry weight of the manufactured soil.
- c. Large Materials: Stones, clods, roots, clay lumps, and pockets of coarse sand exceeding 3 inches (76 mm) in any dimension.

2.2 ACCEPTABLE ORGANIC SOIL AMENDMENTS

- A. No compost should be used in the planting mix.
- B. Sphagnum Peat: Partially decomposed sphagnum peat moss, finely divided or of granular texture with 100 percent passing through a 1/2-inch (13-mm) sieve, a pH of 3.4 to 4.8.
- C. Wood Derivatives: Shredded wood, wood chips, ground bark, or wood waste; of uniform texture and free of stones, sticks, soil, or toxic materials.

PART 3 - EXECUTION

3.1 GENERAL

- A. Place soil media according to requirements in other Specification Sections.
- B. Verify that no foreign or deleterious material or liquid such as paint, paint washout, concrete slurry, asphalt/concrete layers or chunks, cement, plaster, oils, gasoline, diesel fuel, paint thinner, turpentine, tar, roofing compound, solid waste, or acid has been deposited in planting soil.
- C. Proceed with placement only after unsatisfactory conditions have been corrected.
- D. Compaction: Compact each blended lift of soil media to 75 percent of maximum Standard Proctor density according to ASTM D 698
- E. Finish Grading: Grade soil media to a smooth, uniform surface plane with loose, uniformly fine texture. Roll and rake, remove ridges, and fill depressions to meet finish grades.

3.2 FIELD QUALITY CONTROL

- A. Testing Agency: Engage a qualified testing agency to perform tests and inspections.
- B. Perform the following tests and inspections:
 - 1. Compaction: Test planting-soil compaction after placing each lift and at completion using a densitometer or soil-compaction meter calibrated to a reference test value based on laboratory testing according to ASTM D 698.
 - 2. Retain "Performance Testing" Subparagraph below if required; revise to suit Project.
 - 3. Performance Testing: For each amended soil media type, demonstrating compliance with specified performance requirements. Perform testing according to "Soil-Sampling Requirements" and "Testing Requirements" articles.
- C. Soil media will be considered defective if it does not pass tests and inspections.
- D. Prepare test and inspection reports.
- E. Label each sample and test report with the date, location keyed to a site plan or other location system, visible conditions when and where sample was taken, and sampling depth.

3.3 PROTECTION

- A. Protect areas of in-place soil from additional compaction, disturbance, and contamination. Prohibit the following practices within these areas except as required to perform planting operations:
 - 1. Storage of construction materials, debris, or excavated material.
 - 2. Parking vehicles or equipment.
 - 3. Vehicle traffic.
 - 4. Foot traffic.
 - 5. Erection of sheds or structures.
 - 6. Impoundment of water.
 - 7. Excavation or other digging unless otherwise indicated.
- B. If soil media or subgrade is overcompacted, disturbed, or contaminated by foreign or deleterious materials or liquids, remove the soil media and contamination; restore the subgrade as directed by Engineer and replace contaminated soil media with new soil media.

3.4 CLEANING

- A. Protect areas adjacent to soil media preparation and placement areas from contamination. Keep adjacent paving and construction clean and work area in an orderly condition.
- B. Remove surplus soil and waste material including excess subsoil, unsuitable materials, trash, and debris and legally dispose of them off Owner's property unless otherwise indicated.
 - 1. Dispose of excess subsoil and unsuitable materials on-site where directed by Owner.

APPENDIX 4

CONSTRUCTION INSPECTION FORMS

The following construction inspection checklists are from the NYS SMDM.

These checklists include:

- Stormwater/Wetland Pond Construction Inspection Checklist
- Infiltration Trench Construction Inspection Checklist
- Infiltration Basin Construction Inspection Checklist
- Bioretention Construction Inspection Checklist
- Open Channel System Construction Inspection Checklist

Stormwater/Wetland Pond Construction Inspection Checklist

Project:
 Location:
 Site Status:

Date:

Time:

Inspector:

CONSTRUCTION SEQUENCE	SATISFACTORY/ UNSATISFACTORY	COMMENTS
Pre-Construction/Materials and Equipment		
Pre-construction meeting		
Pipe and appurtenances on-site prior to construction and dimensions checked		
1. Material (including protective coating, if specified)		
2. Diameter		
3. Dimensions of metal riser or pre-cast concrete outlet structure		
4. Required dimensions between water control structures (orifices, weirs, etc.) are in accordance with approved plans		
5. Barrel stub for prefabricated pipe structures at proper angle for design barrel slope		
6. Number and dimensions of prefabricated anti-seep collars		
7. Watertight connectors and gaskets		
8. Outlet drain valve		
Project benchmark near pond site		
Equipment for temporary de-watering		

CONSTRUCTION SEQUENCE	SATISFACTORY/ UNSATISFACTORY	COMMENTS
2. Subgrade Preparation		
Area beneath embankment stripped of all vegetation, topsoil, and organic matter		
3. Pipe Spillway Installation		
Method of installation detailed on plans		
A. Bed preparation		
Installation trench excavated with specified side slopes		
Stable, uniform, dry subgrade of relatively impervious material (If subgrade is wet, contractor shall have defined steps before proceeding with installation)		
Invert at proper elevation and grade		
B. Pipe placement		
Metal / plastic pipe		
1. Watertight connectors and gaskets properly installed		
2. Anti-seep collars properly spaced and having watertight connections to pipe		
3. Backfill placed and tamped by hand under "haunches" of pipe		
4. Remaining backfill placed in max. 8 inch lifts using small power tamping equipment until 2 feet cover over pipe is reached		

CONSTRUCTION SEQUENCE	SATISFACTORY/ UNSATISFACTORY	COMMENTS
3. Pipe Spillway Installation		
Concrete pipe		
1. Pipe set on blocks or concrete slab for pouring of low cradle		
2. Pipe installed with rubber gasket joints with no spalling in gasket interface area		
3. Excavation for lower half of anti-seep collar(s) with reinforcing steel set		
4. Entire area where anti-seep collar(s) will come in contact with pipe coated with mastic or other approved waterproof sealant		
5. Low cradle and bottom half of anti-seep collar installed as monolithic pour and of an approved mix		
6. Upper half of anti-seep collar(s) formed with reinforcing steel set		
7. Concrete for collar of an approved mix and vibrated into place (protected from freezing while curing, if necessary)		
8. Forms stripped and collar inspected for honeycomb prior to backfilling. Parge if necessary.		
C. Backfilling		
Fill placed in maximum 8 inch lifts		
Backfill taken minimum 2 feet above top of anti-seep collar elevation before traversing with heavy equipment		

CONSTRUCTION SEQUENCE	SATISFACTORY/ UNSATISFACTORY	COMMENTS
4. Riser / Outlet Structure Installation		
Riser located within embankment		
A. Metal riser		
Riser base excavated or formed on stable subgrade to design dimensions		
Set on blocks to design elevations and plumbed		
Reinforcing bars placed at right angles and projecting into sides of riser		
Concrete poured so as to fill inside of riser to invert of barrel		
B. Pre-cast concrete structure		
Dry and stable subgrade		
Riser base set to design elevation		
If more than one section, no spalling in gasket interface area; gasket or approved caulking material placed securely		
Watertight and structurally sound collar or gasket joint where structure connects to pipe spillway		
C. Poured concrete structure		
Footing excavated or formed on stable subgrade, to design dimensions with reinforcing steel set		
Structure formed to design dimensions, with reinforcing steel set as per plan		
Concrete of an approved mix and vibrated into place (protected from freezing while curing, if necessary)		
Forms stripped & inspected for “honeycomb” prior to backfilling; parge if necessary		

CONSTRUCTION SEQUENCE	SATISFACTORY/ UNSATISFACTORY	COMMENTS
5. Embankment Construction		
Fill material		
Compaction		
Embankment		
1. Fill placed in specified lifts and compacted with appropriate equipment		
2. Constructed to design cross-section, side slopes and top width		
3. Constructed to design elevation plus allowance for settlement		
6. Impounded Area Construction		
Excavated / graded to design contours and side slopes		
Inlet pipes have adequate outfall protection		
Forebay(s)		
Pond benches		
7. Earth Emergency Spillway Construction		
Spillway located in cut or structurally stabilized with riprap, gabions, concrete, etc.		
Excavated to proper cross-section, side slopes and bottom width		
Entrance channel, crest, and exit channel constructed to design grades and elevations		

CONSTRUCTION SEQUENCE	SATISFACTORY / UNSATISFACTORY	COMMENTS
8. Outlet Protection		
A. End section		
Securely in place and properly backfilled		
B. Endwall		
Footing excavated or formed on stable subgrade, to design dimensions and reinforcing steel set, if specified		
Endwall formed to design dimensions with reinforcing steel set as per plan		
Concrete of an approved mix and vibrated into place (protected from freezing, if necessary)		
Forms stripped and structure inspected for "honeycomb" prior to backfilling; parge if necessary		
C. Riprap apron / channel		
Apron / channel excavated to design cross-section with proper transition to existing ground		
Filter fabric in place		
Stone sized as per plan and uniformly place at the thickness specified		
9. Vegetative Stabilization		
Approved seed mixture or sod		
Proper surface preparation and required soil amendments		
Excelsior mat or other stabilization, as per plan		

CONSTRUCTION SEQUENCE	SATISFACTORY/ UNSATISFACTORY	COMMENTS
10. Miscellaneous		
Drain for ponds having a permanent pool		
Trash rack / anti-vortex device secured to outlet structure		
Trash protection for low flow pipes, orifices, etc.		
Fencing (when required)		
Access road		
Set aside for clean-out maintenance		
11. Stormwater Wetlands		
Adequate water balance		
Variety of depth zones present		
Approved pondscaping plan in place Reinforcement budget for additional plantings		
Plants and materials ordered 6 months prior to construction		
Construction planned to allow for adequate planting and establishment of plant community (April-June planting window)		
Wetland buffer area preserved to maximum extent possible		

Comments:

Actions to be Taken:

Infiltration Trench Construction Inspection Checklist

Project:
 Location:
 Site Status:

Date:

Time:

Inspector:

CONSTRUCTION SEQUENCE	SATISFACTORY/ UNSATISFACTORY	COMMENTS
1. Pre-Construction		
Pre-construction meeting		
Runoff diverted		
Soil permeability tested		
Groundwater / bedrock sufficient at depth		
2. Excavation		
Size and location		
Side slopes stable		
Excavation does not compact subsoils		
3. Filter Fabric Placement		
Fabric specifications		
Placed on bottom, sides, and top		

CONSTRUCTION SEQUENCE	SATISFACTORY / UNSATISFACTORY	COMMENTS
4. Aggregate Material		
Size as specified		
Clean / washed material		
Placed properly		
5. Observation Well		
Pipe size		
Removable cap / footplate		
Initial depth = _____ feet		
6. Final Inspection		
Pretreatment facility in place		
Contributing watershed stabilized prior to flow diversion		
Outlet		

Comments:

Infiltration Basin Construction Inspection Checklist

Project:
 Location:
 Site Status:

Date:

Time:

Inspector:

CONSTRUCTION SEQUENCE	SATISFACTORY/ UNSATISFACTORY	COMMENTS
1. Pre-Construction		
Runoff diverted		
Soil permeability tested		
Groundwater / bedrock depth		
2. Excavation		
Size and location		
Side slopes stable		
Excavation does not compact subsoils		
3. Embankment		
Barrel		
Anti-seep collar or Filter diaphragm		
Fill material		

Bioretention Construction Inspection Checklist

Project:
 Location:
 Site Status:

Date:

Time:

Inspector:

CONSTRUCTION SEQUENCE	SATISFACTORY/ UNSATISFACTORY	COMMENTS
1. Pre-Construction		
Pre-construction meeting		
Runoff diverted		
Facility area cleared		
If designed as exfilter, soil testing for permeability		
Facility location staked out		
2. Excavation		
Size and location		
Lateral slopes completely level		
If designed as exfilter, ensure that excavation does not compact susoils.		
Longitudinal slopes within design range		

CONSTRUCTION SEQUENCE	SATISFACTORY / UNSATISFACTORY	COMMENTS
3. Structural Components		
Stone diaphragm installed correctly		
Outlets installed correctly		
Underdrain		
Pretreatment devices installed		
Soil bed composition and texture		
4. Vegetation		
Complies with planting specs		
Topsoil adequate in composition and placement		
Adequate erosion control measures in place		
5. Final Inspection		
Dimensions		
Proper stone diaphragm		
Proper outlet		
Soil/ filter bed permeability testing		
Effective stand of vegetation and stabilization		
Construction generated sediments removed		
Contributing watershed stabilized before flow is diverted to the practice		

Open Channel System Construction Inspection Checklist

Project:
 Location:
 Site Status:

Date:

Time:

Inspector:

CONSTRUCTION SEQUENCE	SATISFACTORY / UNSATISFACTORY	COMMENTS
1. Pre-Construction		
Pre-construction meeting		
Runoff diverted		
Facility location staked out		
2. Excavation		
Size and location		
Side slope stable		
Soil permeability		
Groundwater / bedrock		
Lateral slopes completely level		
Longitudinal slopes within design range		
Excavation does not compact subsoils		
3. Check dams		
Dimensions		
Spacing		
Materials		

CONSTRUCTION SEQUENCE	SATISFACTORY / UNSATISFACTORY	COMMENTS
4. Structural Components		
Underdrain installed correctly		
Inflow installed correctly		
Pretreatment devices installed		
5. Vegetation		
Complies with planting specifications		
Topsoil adequate in composition and placement		
Adequate erosion control measures in place		
6. Final inspection		
Dimensions		
Check dams		
Proper outlet		
Effective stand of vegetation and stabilization		
Contributing watershed stabilized before flow is routed to the facility		

Comments:

APPENDIX 5

OPERATION & MAINTENANCE INSPECTION FORMS

The following is a collection of maintenance inspection forms including:

- NYS SMDM Maintenance Inspection Checklists
 - Stormwater Pond/Wetland Operation, Maintenance and Management Inspection Checklist;
 - Infiltration Trench Operation, Maintenance and Management Inspection Checklist;
 - Bioretention Operation, Maintenance and Management Inspection Checklist; and
 - Open Channel Operation, Maintenance and Management Inspection Checklist.
- Save the Rain (Onondaga County, NY) Green Infrastructure Maintenance Report Log
 - Porous Pavement Maintenance;
 - Porous Paver Maintenance;
 - Stormwater Structure Cleaning;
 - Green Roof; and
 - Landscaping.
- University of New Hampshire Storm Center Biofilter Maintenance Guidance
- University of New Hampshire Storm Center Porous Pavement Maintenance Guidance

Many additional maintenance inspection forms have been developed. Other examples include the NYS DEC Maintenance Guidance for Stormwater Management Practices, and the Inventory of Maintenance Practices and Procedures by GSI practice, which is an appendix to the City of Philadelphia Combined Sewer Overflow Long Term Control Plan Update.

These Inspection Forms could be used as is, or as templates for a Monroe County Maintenance and Inspection document.

Stormwater Pond/Wetland Operation, Maintenance and Management Inspection Checklist

Project _____

Location: _____

Site Status: _____

Date: _____

Time: _____

Inspector: _____

Maintenance Item	Satisfactory/ Unsatisfactory	Comments
1. Embankment and emergency spillway (Annual, After Major Storms)		
1. Vegetation and ground cover adequate		
2. Embankment erosion		
3. Animal burrows		
4. Unauthorized planting		
5. Cracking, bulging, or sliding of dam		
a. Upstream face		
b. Downstream face		
c. At or beyond toe		
downstream		
upstream		
d. Emergency spillway		
6. Pond, toe & chimney drains clear and functioning		
7. Seeps/leaks on downstream face		
8. Slope protection or riprap failure		
9. Vertical/horizontal alignment of top of dam "As-Built"		

Maintenance Item	Satisfactory/ Unsatisfactory	Comments
10. Emergency spillway clear of obstructions and debris		
11. Other (specify)		
2. Riser and principal spillway (Annual)		
Type: Reinforced concrete _____ Corrugated pipe _____ Masonry _____		
1. Low flow orifice obstructed		
2. Low flow trash rack. a. Debris removal necessary		
b. Corrosion control		
3. Weir trash rack maintenance a. Debris removal necessary		
b. corrosion control		
4. Excessive sediment accumulation insider riser		
5. Concrete/masonry condition riser and barrels a. cracks or displacement		
b. Minor spalling (<1")		
c. Major spalling (rebars exposed)		
d. Joint failures		
e. Water tightness		
6. Metal pipe condition		
7. Control valve a. Operational/exercised		
b. Chained and locked		
8. Pond drain valve a. Operational/exercised		
b. Chained and locked		
9. Outfall channels functioning		
10. Other (specify)		

Maintenance Item	Satisfactory/ Unsatisfactory	Comments
3. Permanent Pool (Wet Ponds) (monthly)		
1. Undesirable vegetative growth		
2. Floating or floatable debris removal required		
3. Visible pollution		
4. Shoreline problem		
5. Other (specify)		
4. Sediment Forebays		
1. Sedimentation noted		
2. Sediment cleanout when depth < 50% design depth		
5. Dry Pond Areas		
1. Vegetation adequate		
2. Undesirable vegetative growth		
3. Undesirable woody vegetation		
4. Low flow channels clear of obstructions		
5. Standing water or wet spots		
6. Sediment and / or trash accumulation		
7. Other (specify)		
6. Condition of Outfalls (Annual , After Major Storms)		
1. Riprap failures		
2. Slope erosion		
3. Storm drain pipes		
4. Endwalls / Headwalls		
5. Other (specify)		
7. Other (Monthly)		
1. Encroachment on pond, wetland or easement area		

Maintenance Item	Satisfactory/ Unsatisfactory	Comments
2. Complaints from residents		
3. Aesthetics a. Grass growing required		
b. Graffiti removal needed		
c. Other (specify)		
4. Conditions of maintenance access routes.		
5. Signs of hydrocarbon build-up		
6. Any public hazards (specify)		
8. Wetland Vegetation (Annual)		
1. Vegetation healthy and growing Wetland maintaining 50% surface area coverage of wetland plants after the second growing season. (If unsatisfactory, reinforcement plantings needed)		
2. Dominant wetland plants: Survival of desired wetland plant species Distribution according to landscaping plan?		
3. Evidence of invasive species		
4. Maintenance of adequate water depths for desired wetland plant species		
5. Harvesting of emergent plantings needed		
6. Have sediment accumulations reduced pool volume significantly or are plants "choked" with sediment		
7. Eutrophication level of the wetland.		
8. Other (specify)		

Comments:

Actions to be Taken:

Infiltration Trench Operation, Maintenance, and Management Inspection Checklist

Project:
 Location:
 Site Status:

Date:

Time:

Inspector:

MAINTENANCE ITEM	SATISFACTORY / UNSATISFACTORY	COMMENTS
1. Debris Cleanout (Monthly)		
Trench surface clear of debris		
Inflow pipes clear of debris		
Overflow spillway clear of debris		
Inlet area clear of debris		
2. Sediment Traps or Forebays (Annual)		
Obviously trapping sediment		
Greater than 50% of storage volume remaining		
3. Dewatering (Monthly)		
Trench dewaterers between storms		
4. Sediment Cleanout of Trench (Annual)		
No evidence of sedimentation in trench		
Sediment accumulation doesn't yet require cleanout		
5. Inlets (Annual)		

MAINTENANCE ITEM	SATISFACTORY / UNSATISFACTORY	COMMENTS
Good condition		
No evidence of erosion		
6. Outlet/Overflow Spillway (Annual)		
Good condition, no need for repair		
No evidence of erosion		
7. Aggregate Repairs (Annual)		
Surface of aggregate clean		
Top layer of stone does not need replacement		
Trench does not need rehabilitation		

Comments:

Actions to be Taken:

Bioretention Operation, Maintenance and Management Inspection Checklist

Project:
 Location:
 Site Status:

Date:

Time:

Inspector:

MAINTENANCE ITEM	SATISFACTORY / UNSATISFACTORY	COMMENTS
1. Debris Cleanout (Monthly)		
Bioretention and contributing areas clean of debris		
No dumping of yard wastes into practice		
Litter (branches, etc.) have been removed		
2. Vegetation (Monthly)		
Plant height not less than design water depth		
Fertilized per specifications		
Plant composition according to approved plans		
No placement of inappropriate plants		
Grass height not greater than 6 inches		
No evidence of erosion		
3. Check Dams/Energy Dissipaters/Sumps (Annual, After Major Storms)		
No evidence of sediment buildup		

MAINTENANCE ITEM	SATISFACTORY / UNSATISFACTORY	COMMENTS
Sumps should not be more than 50% full of sediment		
No evidence of erosion at downstream toe of drop structure		
4. Dewatering (Monthly)		
Dewaterers between storms		
No evidence of standing water		
5. Sediment Deposition (Annual)		
Swale clean of sediments		
Sediments should not be > 20% of swale design depth		
6. Outlet/Overflow Spillway (Annual, After Major Storms)		
Good condition, no need for repair		
No evidence of erosion		
No evidence of any blockages		
7. Integrity of Filter Bed (Annual)		
Filter bed has not been blocked or filled inappropriately		

Comments:

Actions to be Taken:

Open Channel Operation, Maintenance, and Management Inspection Checklist

Project:
 Location:
 Site Status:

Date:

Time:

Inspector:

MAINTENANCE ITEM	SATISFACTORY/ UNSATISFACTORY	COMMENTS
1. Debris Cleanout (Monthly)		
Contributing areas clean of debris		
2. Check Dams or Energy Dissipators (Annual, After Major Storms)		
No evidence of flow going around structures		
No evidence of erosion at downstream toe		
Soil permeability		
Groundwater / bedrock		
3. Vegetation (Monthly)		
Mowing done when needed		
Minimum mowing depth not exceeded		
No evidence of erosion		
Fertilized per specification		
4. Dewatering (Monthly)		
Dewaterers between storms		

MAINTENANCE ITEM	SATISFACTORY/ UNSATISFACTORY	COMMENTS
5. Sediment deposition (Annual)		
Clean of sediment		
6. Outlet/Overflow Spillway (Annual)		
Good condition, no need for repairs		
No evidence of erosion		

Comments:

Actions to be Taken:

Save the Rain: Green Infrastructure Program Maintenance Report Log

PM Task Name: Porous Pavement Maintenance – Porous Asphalt/Concrete & Flexipave

Truck Number: _____

Weather Conditions: _____

Location Name: _____

Location Address: _____

Task Code: _____

Task Description: _____

Task Start Date: _____

Personnel/Task Start Time: _____

Task End Date: _____

Personnel/Task End Time: _____

Labor Personnel Name: Phil Centore

Paul Legnetto Other: _____

Tools Used: Broom

Maximo Item No. 2376

Flat Shovel

Maximo Item No. 8491

Rake

Maximo Item No. 18209

Dust Pan

Maximo Item No. 8386

Other: _____

Maximo Item No. _____

Other: _____

Maximo Item No. _____

Materials Used: Plastic Bag

Maximo Item No. 4478 Qty: _____

Other: _____

Maximo Item No. _____ Qty: _____

Other: _____

Maximo Item No. _____ Qty: _____

VACUUMING (Please submit photos if necessary) Maximo Task Code: _____

Vacuum Type/Manufacturer: _____

Hour Meter Start: _____ Hour Meter End: _____ Number of Passes: _____

Weight/Amount of Material Collected (# bags x pounds or gallons/bag): _____

Description of Collected Materials: _____

Description of Vacuumed Materials: _____

Notes: _____

POWER WASHING (Please submit photos if necessary) Maximo Task Code: _____

Power Washer Type/Manufacturer: _____

Hour Meter Start: _____ Hour Meter End: _____ Number of Passes: _____

Notes: _____

WINTER MAINTENANCE (Please submit photos if necessary) Maximo Task Code: _____

Plow Type/Manufacturer: _____

Hour Meter Start: _____ Hour Meter End: _____ Number of Passes: _____

Plowing Notes: _____

Deicing Salt Type/Product Used, if Applicable: _____

Amount Used: _____

Notes: _____

RIVERSTONE EDGE MAINTENANCE (Please submit photos if necessary) Maximo Task Code: _____

Existing Condition of Riverstone and Amount of Weed Growth: _____

Weeds Removed from Riverstone? (YES/NO): _____

Type/Specification of Riverstone Used to Replenish Riverstone: _____

Amount of Riverstone Used: _____

Notes: _____

Save the Rain: Green Infrastructure Program Maintenance Report Log

PM Task Name: Porous Paver Maintenance

Truck Number: _____

Weather Conditions: _____

Location Name: _____

Location Address: _____

Task Code: _____

Task Description: _____

Task Start Date: _____

Personnel/Task Start Time: _____

Task End Date: _____

Personnel/Task End Time: _____

Labor Personnel Name: Phil Centore

Paul Legnetto Other: _____

Tools Used: Broom

Maximo Item No. 2376

Flat Shovel

Maximo Item No. 8491

Rake

Maximo Item No. 18209

Dust Pan

Maximo Item No. 8386

Other: _____

Maximo Item No. _____

Other: _____

Maximo Item No. _____

Materials Used: Plastic Bag

Maximo Item No. 4478 Qty: _____

Other: _____

Maximo Item No. _____ Qty: _____

Other: _____

Maximo Item No. _____ Qty: _____

VACUUMING (Please submit photos if necessary) Maximo Task Code: _____

Vacuum Type/Manufacturer: _____

Hour Meter Start: _____ Hour Meter End: _____ Number of Passes: _____

Weight/Amount of Material Collected (# bags x pounds or gallons/bag): _____

Description of Collected Materials: _____

Description of Vacuumed Materials: _____

Notes: _____

REFILLING VOIDS WITH AGGREGATE (Please submit photos if necessary) Maximo Task Code: _____

Type/Specification of Aggregate Used: _____

Amount of Aggregate Used to Refill Voids: _____

Notes: _____

WINTER MAINTENANCE (Please submit photos if necessary) Maximo Task Code: _____

Plow Type/Manufacturer: _____

Hour Meter Start: _____ Hour Meter End: _____ Number of Passes: _____

Plowing Notes: _____

Deicing Salt Type/Product Used, if Applicable: _____

Amount Used: _____

Notes: _____

RIVERSTONE EDGE MAINTENANCE (Please submit photos if necessary) Maximo Task Code: _____

Existing Condition of Riverstone and Amount of Weed Growth: _____

Weeds Removed from Riverstone? (YES/NO): _____

Type/Specification of Riverstone Used to Replenish Riverstone: _____

Amount of Riverstone Used: _____

Notes: _____

Save the Rain: Green Infrastructure Program Maintenance Report Log

PM Task Name: Stormwater Structure Cleaning

Truck Number: _____

Weather Conditions: _____

Location Name: _____

Location Address: _____

Task Code: _____

Task Description: _____

Task Start Date: _____

Personnel/Task Start Time: _____

Task End Date: _____

Personnel/Task End Time: _____

Labor Personnel Name: Phil Centore

Paul Legnetto Other: _____

Tools Used: Broom

Maximo Item No. 2376

Flat Shovel

Maximo Item No. 8491

Rake

Maximo Item No. 18209

Dust Pan

Maximo Item No. 8386

Other: _____

Maximo Item No. _____

Other: _____

Maximo Item No. _____

Materials Used: Plastic Bag

Maximo Item No. 4478 Qty: _____

Other: _____

Maximo Item No. _____ Qty: _____

Other: _____

Maximo Item No. _____ Qty: _____

STORMWATER STRUCTURE MAINTENANCE (*Please submit photos if necessary*) Maximo Task Code: _____

Type of Stormwater Structure: _____

Condition of Interior of Stormwater Structure: _____

Types of Debris/Leaf Litter/Sediment Found inside Structure: _____

Vacuum Type/Manufacturer: _____

Hour Meter Start: _____ Hour Meter End: _____

Weight/Amount of Vacuumed Material: _____

Description of Vacuumed Materials: _____

Notes: _____

INLET FILTER INSERT MAINTENANCE (*Please submit photos if necessary*) Maximo Task Code: _____

Condition of Existing Inlet Filter Insert: _____

Vacuum Type/Manufacturer: _____

Hour Meter Start: _____ Hour Meter End: _____

Description of Vacuumed Materials: _____

Notes about Vacuumed Materials: _____

Filter Insert Successfully Reattached? (YES/NO): _____

Replacement of Filter Insert? (YES/NO): _____

Type of Filter Insert Replaced: _____

Notes: _____

RIVERSTONE EDGE MAINTENANCE (*Please submit photos if necessary*) Maximo Task Code: _____

Existing Condition of Riverstone and Amount of Weed Growth: _____

Weeds Removed from Riverstone? (YES/NO): _____

Type/Specification of Riverstone Used to Replenish Riverstone: _____

Amount of Riverstone Used: _____

Notes: _____

Save the Rain: Green Infrastructure Program Maintenance Report Log

PM Task Name: Green Roof

Truck Number: _____

Weather Conditions: _____

Location Name: _____

Location Address: _____

Task Code: _____

Task Description: _____

Task Start Date: _____

Personnel/Task Start Time: _____

Task End Date: _____

Personnel/Task End Time: _____

Labor Personnel Name: Phil Centore

Paul Legnetto Other: _____

Tools Used: Broom

Maximo Item No. 2376

Flat Shovel

Maximo Item No. 8491

Rake

Maximo Item No. 18209

Dust Pan

Maximo Item No. 8386

Other: _____

Maximo Item No. _____

Other: _____

Maximo Item No. _____

Materials Used: Plastic Bag

Maximo Item No. 4478 Qty: _____

Other: _____

Maximo Item No. _____ Qty: _____

Other: _____

Maximo Item No. _____ Qty: _____

GREEN ROOF MAINTENANCE (*Please submit photos if necessary*) Maximo Task Code: _____

Condition of Green Roof Plants: _____

Condition of Waterproofing System (Flashings/Counter-Flashings): _____

Condition of Drainage System (Scuppers/Outlets): _____

Amount of Weeds Present: _____

Plant Replacement/Replenishment Necessary? (YES/NO): _____

Number/Amount of Plants Planted: _____

Types of Species (If Known): _____

Notes: _____

Save the Rain: Green Infrastructure Program Maintenance Report Log

PM Task Name: Landscaping - Trees/Shrubs/Vegetation

Truck Number: _____

Weather Conditions: _____

Location Name: _____

Location Address: _____

Task Code: _____

Task Description: _____

Task Start Date: _____

Personnel/Task Start Time: _____

Task End Date: _____

Personnel/Task End Time: _____

Labor Personnel Name: Phil Centore

Paul Legnetto Other: _____

Tools Used: Broom

Maximo Item No. 2376

Flat Shovel

Maximo Item No. 8491

Rake

Maximo Item No. 18209

Dust Pan

Maximo Item No. 8386

Other: _____

Maximo Item No. _____

Other: _____

Maximo Item No. _____

Materials Used: Plastic Bag

Maximo Item No. 4478 Qty: _____

Other: _____

Maximo Item No. _____ Qty: _____

Other: _____

Maximo Item No. _____ Qty: _____

LANDSCAPE GENERAL MAINTENANCE (Please submit photos if necessary) Maximo Task Code: _____

Condition of Trees: _____

Are Root Flares Present? Are trees planted too deep or too shallow? _____

Arborist Follow-Up Visit Necessary? If yes, note which trees: _____

Condition of Shrubs: _____

Condition of Perennials/Grasses/Herbaceous Plants: _____

Amount of Weeds Present: _____

Plant Replacement/Replenishment Necessary? (YES/NO): _____

Notes: _____

LANDSCAPE WEEDING (Please submit photos if necessary) Maximo Task Code: _____

Amount of Weeds Removed/Types of Weeds (If Known): _____

Are invasive species present? (YES/NO if known): _____

Herbicide Used? (Control of Invasive Species Only and Permission Obtained): _____

Type of Herbicide Used: _____

Amount Used: _____

Notes: _____

LANDSCAPE MULCHING (Please submit photos if necessary) Maximo Task Code: _____

What was mulched? Tree Pits Trees Plant Beds Rain Gardens Other: _____

Type of Mulch Used: _____

Amount of Mulch Used: _____

Notes: _____

LANDSCAPE WATERING (Please submit photos if necessary) Maximo Task Code: _____

Amount/Volume of Water Applied: _____

Rate of Watering: _____

Notes: _____

TREE FERTILIZATION (Please submit photos if necessary) Maximo Task Code: _____

Type of Organic Matter/Mycorrhizae Used: _____

Amount Organic Matter/Mycorrhizae Applied: _____

Notes: _____

PRUNING OF TREES AND SHRUBS (Please submit photos if necessary) Maximo Task Code: _____

Type of Pruning Done? Deadwood Structural Other: _____

What was pruned? Trees Shrubs Other: _____

Arborist Follow-Up Visit Necessary? If yes, note which trees: _____

Notes: _____

PLANT DIVISION/CUTBACK: (Please submit photos if necessary) Maximo Task Code: _____

Approximate number/square footage of plants cut back/dead vegetation removed: _____

Perennials divided? YES/NO _____

Grasses divided? YES/NO _____

Species divided (If known): _____

Notes: _____

LANDSCAPE REPLACEMENT (Please submit photos if necessary) Maximo Task Code: _____

Plant Replacement/Replenishment Necessary? (YES/NO): _____

What was replaced? (Circle answer) Trees Shrubs Perennials Grasses Other

Number/Amount of Plants Planted: _____

Types of Species (If Known): _____

Notes: _____

MEADOW MOWING (Please submit photos if necessary) Maximo Task Code: _____

Mower Type/Manufacturer: _____

Hour Meter Start: _____ Hour Meter End: _____ Number of Passes: _____

Height of Mow Blade: _____

Notes: _____

Additional Notes (Please submit photos if necessary):

Regular Inspection and Maintenance Guidance for Bioretention Systems / Tree Filters

Maintenance of bioretention systems and tree filters can typically be performed as part of standard landscaping. Regular inspection and maintenance is critical to the effective operation of bioretention systems and tree filters to insure they remain clear of leaves and debris and free draining. This page provides guidance on maintenance activities that are typically required for these systems, along with the suggested frequency for each activity. Individual systems may have more, or less, frequent maintenance needs, depending on a variety of factors including the occurrence of large storm events, overly wet or dry (I.E., drought), regional hydrologic conditions, and the upstream land use.

ACTIVITIES

The most common maintenance activity is the removal of leaves from the system and bypass structure. Visual inspections are routine for system maintenance. This includes looking for standing water, accumulated leaves, holes in the soil media, signs of plant distress, and debris and sediment accumulation in the system. Mulch and/or vegetation coverage is integral to the performance of the system, including infiltration rate and nutrient uptake. Vegetation care is important to system productivity and health.

ACTIVITY	FREQUENCY
A record should be kept of the time to drain for the system completely after a storm event. The system should drain completely within 72 hours.	
Check to insure the filter surface remains well draining after storm events. Remedy: If filter bed is clogged, draining poorly, or standing water covers more than 15% of the surface 48 hours after a precipitation event, then remove top few inches of discolored material. Till or rake remaining material as needed.	After every major storm in the first few months, then biannually.
Check inlets and outlets for leaves and debris. Remedy: Rake in and around the system to clear it of debris. Also, clear the inlet and overflow if obstructed.	Quarterly initially, biannually, frequency adjusted as needed after 3 inspections
Check for animal burrows and short circuiting in the system. Remedy: Soil erosion from short circuiting or animal borroughs should be repaired when they occur. The holes should be filled and lightly compacted	
Check to insure the filter bed does not contain more than 2 inches accumulated material Remedy: Remove sediment as necessary. If 2 inches or more of filter bed has been removed, replace media with either mulch or a (50% sand, 20% woodchips, 20% compost, 10% soil) mixture.	
During extended periods without rainfall, inspect plants for signs of distress. Remedy: Plants should be watered until established (typical only for first few months) or as needed thereafter.	
Inspect inlets and outlets to ensure good condition and no evidence of deterioration. Check to see if high-flow bypass is functioning. Remedy: Repair or replace any damaged structural parts, inlets, outlets, sidewalls.	Annually
Check for robust vegetation coverage throughout the system. Remedy: If at least 50 % vegetation coverage is not established after 2 years, reinforcement planting should be performed.	
Check for dead or dying plants, and general long term plant health. Remedy: This vegetation should be cut and removed from the system. If woody vegetation is present, care should be taken to remove dead or decaying plant Material. Separation of Herbaceous vegetation rootstock should occur when over-crowding is observed.	As needed

CHECKLIST FOR INSPECTION OF BIORETENTION SYSTEM / TREE FILTERS

Location:

Inspector:

Date:

Time:

Site Conditions:

Date Since Last Rain Event:

Inspection Items	Satisfactory (S) or Unsatisfactory (U)	Comments/Corrective Action
1. Initial Inspection After Planting and Mulching		
Plants are stable, roots not exposed	S U	
Surface is at design level, typically 4" below overpass	S U	
Overflow bypass / inlet (if available) is functional	S U	
2. Debris Cleanup (2 times a year minimum, Spring & Fall)		
Litter, leaves, and dead vegetation removed from the system	S U	
Prune perennial vegetation	S U	
3. Standing Water (1 time a year, After large storm events)		
No evidence of standing water after 72 hours	S U	
4. Short Circuiting & Erosion (1 times a year, After large storm events)		
No evidence of animal burrows or other holes	S U	
No evidence of erosion	S U	
5. Drought Conditions (As needed)		
Water plants as needed	S U	
Dead or dying plants	S U	
6. Overflow Bypass / Inlet Inspection (1 times a year, After large storm events)		
No evidence of blockage or accumulated leaves	S U	
Good condition, no need for repair	S U	
7. Vegetation Coverage (once a year)		
50 % coverage established throughout system by first year	S U	
Robust coverage by year 2 or later	S U	
8. Mulch Depth (if applicable)(once every 2 years)		
Mulch at original design depth after tilling or replacement	S U	
9. Vegetation Health (once every 3 years)		
Dead or decaying plants removed from the system	S U	
10. Tree Pruning (once every 3 years)		
Prune dead, diseased, or crossing branches	S U	
Corrective Action Needed		Due Date
1.		
2.		
3.		

Regular Inspection and Maintenance Guidance for Porous Pavements

Regular inspection and maintenance is critical to the effective operation of porous pavement. It is the responsibility of the owner to maintain the pavement in accordance with the minimum design standards. This page provides guidance on maintenance activities that are typically required for these systems, along with the suggested frequency for each activity. Individual systems may have more, or less, frequent maintenance needs, depending on a variety of factors including the occurrence of large storm events, seasonal changes, and traffic conditions.

Inspection Activities

Visual inspections are an integral part of system maintenance. This includes monitoring pavement to ensure water drainage, debris accumulation, and surface deterioration.

ACTIVITY	FREQUENCY
Check for standing water on the surface of the pavement after a precipitation event. If standing water remains within 30 minutes after rainfall had ended, cleaning of porous pavement is recommended.	2 to 4 times per year, more frequently for high use sites or sites with higher potential for run-on
Vacuum sweeper shall be used regularly to remove sediment and organic debris on the pavement surface. The sweeper may be fitted with water jets.	
Pavement vacuuming should occur during spring cleanup following the last snow event to remove accumulated debris, at minimum.	
Pavement vacuuming should occur during fall cleanup to remove dead leaves, at minimum.	
Power washing can be an effective tool for cleaning clogged areas. This should occur at mid pressure typically less than 500 psi and at an angle of 30 degrees or less.	
Check for debris accumulating on pavement, especially debris buildup in winter. For loose debris, a power/leaf blower or gutter broom can be used to remove leaves and trash.	
Check for damage to porous pavements from non-design loads. Damaged areas may be repaired by use of infrared heating and rerolling of pavement. Typical costs may be 2,000/ day for approximately 500 ft of trench.	

Maintenance Activities

Routine preventative cleaning is more effective than corrective cleaning.

Activity	Frequency
Controlling run-on and debris tracking is key to extending the life of porous surfaces. Erosion and sedimentation control of adjacent areas is crucial. Vacuuming adjacent non porous asphalt can be effective at minimizing run-on.	Whenever vacuuming adjacent porous pavements
Repairs may be needed from cuts of utilities. Repairs can be made using standard (non-porous) asphalt for most damages. Repairs using standard asphalt should not exceed 15% of total area.	As needed
Do not store materials such as sand/salt, mulch, soil, yard waste, and other stock piles on porous surfaces.	
Stockpiled snow areas on porous pavements will require additional maintenance and vacuuming. Stockpiling on snow on porous pavements is not recommended and will lead to premature clogging.	
Damage can occur to porous pavement from non-design loads. Precautions such as clearance bars, signage, tight turning radius, high curbs, and video surveillance may be required where there is a risk off non-design loads.	
Posting of signage is recommended indicating presence of porous pavement. Signage should display limitation of design load (i.e. passenger vehicles only, light truck traffic, etc. as per pavement durability rating.)	

CHECKLIST FOR INSPECTION OF POROUS PAVEMENTS

Location:

Inspector:

Date:

Time:

Site Conditions:

Date Since Last Rain Event:

Inspection Items	Satisfactory (S) or Unsatisfactory (U)	Comments/Corrective Action
1. Salt / Deicing *Note complete winter maintenance guidance is available at UNHSC		
Use salt only for ice management	S U	
Piles of accumulated salt removed in spring	S U	
2. Debris Cleanup (2-4 times a year minimum, Spring & Fall)		
Clean porous pavement to remove sediment and organic debris on the pavement surface via vacuum street sweeper.	S U	
Adjacent non porous pavement vacuumed	S U	
Clean catch basins (if available)	S U	
3. Controlling Run-On (2-4 times a year)		
Adjacent vegetated areas show no signs of erosion and run-on to porous pavement	S U	
4. Outlet / Catch Basin Inspection (if available) (2 times a year, After large storm events)		
No evidence of blockage	S U	
Good condition, no need for cleaning/repair	S U	
5. Poorly Drained Pavement (2-4 times a year)		
Pavement has been pressure washed and vacuumed	S U	
6. Pavement Condition (2-4 times a year minimum, Spring & Fall)		
No evidence of deterioration	S U	
No cuts from utilities visible	S U	
No evidence of improper design load applied	S U	
7. Signage / Stockpiling (As Needed)		
Proper signage posted indicating usage for traffic load	S U	
No stockpiling of materials and no seal coating	S U	

Corrective Action Needed	Due Date
1.	
2.	
3.	

APPENDIX 6

SAMPLE MAINTENANCE AGREEMENT

The following is a Sample Inspection and Maintenance Agreement for Stormwater Management Facilities on private property. It is based on other maintenance agreements for GI practices in New York. The sample maintenance agreement should be edited to reflect specific GI practices, and reviewed by legal counsel, before being used.

SAMPLE INSPECTION AND MAINTENANCE AGREEMENT
OF PRIVATE STORMWATER MANAGEMENT FACILITIES

THIS AGREEMENT, made this ____ day of _____, 20____, by and between _____
hereinafter referred as the "OWNER(S)" of the following property:
_____, and the Town of _____, New York, hereinafter referred
to as the "TOWN",

WITNESSETH, that

WHEREAS, the OWNER of certain real property described as
(Tax Map Information) _____ as recorded by deed
in the land records of the Town of _____, New York, Deed Book _____ Page _____, hereinafter
called the "Property".

WHEREAS, the OWNER is proceeding to build on and develop the property; and

WHEREAS, the Stormwater Pollution Prevention Plan developed for the

(Name of Plan/Development) _____,

hereinafter called the "Plan", which is expressly made a part hereof, as approved or to be approved by the TOWN,

WHEREAS, the TOWN and the OWNER, its successors and assigns, require that on-site stormwater management
facilities be constructed and maintained on the Property; and

WHEREAS, the TOWN requires that on-site stormwater management facilities as shown on the Plan be constructed
and adequately maintained by the OWNER, its successors and assigns.

NOW, THEREFORE, in consideration of the foregoing premises, the mutual covenants contained herein, and the
following terms and conditions, the parties hereto agree as follows:

1. The on-site stormwater management facilities shall be constructed by the OWNER, its successors and assigns, in accordance with the plans and specifications identified in the Plan.
2. The OWNER, its successors and assigns, shall adequately maintain the stormwater management facilities as outlined in the Plan. This includes all pipes and channels built to convey stormwater to the facility, as well as all structures, improvements, and vegetation provided to control the quantity and quality of the stormwater. Adequate maintenance is herein defined as good working condition so that these facilities are performing their design functions.
3. The OWNER shall repair and maintain the stormwater management system to ensure that it shall remain in full operation. In connection with this duty, (per the NYS SMDM) the OWNER shall do the following:
 - a. Sediment shall be cleaned out of the sedimentation chamber when it accumulates to a depth of more than six inches. Vegetation within the sedimentation chamber shall be limited to a height of 18 inches. The sediment chamber outlet devices shall be cleaned/ repaired when drawdown times exceed 36 hours. Trash and debris shall be removed as necessary.
 - b. Silt/sediment shall be removed from the filter bed when the accumulation exceeds one inch. When the filtering capacity of the filter diminishes substantially (i.e., when water ponds on the surface of the filter bed for more than 48 hours), the top few inches of discolored material shall be removed and shall be replaced with fresh material. The removed sediments shall be disposed of in an acceptable manner (i.e., landfill)

4. The OWNER represents and ensures that the following design documents contain all necessary information to construct, operate and maintain the stormwater management facilities for the lifetime of the facilities, as required by NYSDEC for compliance with the conditions of NYSDEC GP-02-01
 - a. Site Plans approved by the Town Board on (Month)____ (Day)____, (Year) 20____ consisting of a cover sheet and drawings (list)_____, _____, _____, _____, prepared by _____.
 - b. Storm Water Pollution Prevention Plan (SWPPP) dated (Month)____ (Day)____, (Year) 20____, prepared by _____.
 - c. Maintenance plan with associated operations and maintenance manuals, dated (Month)____ (Day)____, (Year) 20____, prepared by _____.
 - d. Any amendments to the documents set forth in this paragraph, approved by the TOWN.
5. The OWNER shall arrange for the periodic inspection of the stormwater management system, not less than once in every 12 months, to determine the condition and integrity of the system. Such inspection shall be performed by a licensed/certified professional in the State of New York, retained by the OWNER. The inspecting professional shall prepare and submit to the TOWN, within 30-days of the inspection, a written report of the findings including recommendations for those actions necessary for the continuation of the system. The inspection report shall be certified to both the OWNER and to the TOWN.
6. The OWNER shall undertake all recommended actions and necessary repairs including replacement of the stormwater control measures in accordance with the recommendations of the inspecting engineer or as directed by the TOWN. The OWNER is responsible for all related expenses.
7. Failure to properly maintain the stormwater management facility could potentially result in a violation of the New York State Environmental Conservation Law.
8. The TOWN may enter the property at reasonable times and in a reasonable manner for the purpose of inspecting the stormwater management system. Inspections may include, but are not limited to: reviewing maintenance and repair records; sampling discharges, surface water, groundwater, and material or water in drainage control facilities; and evaluating the condition of drainage control facilities and other stormwater management practices. The purpose of inspection is to follow-up on reported deficiencies and/or to respond to citizen complaints. The TOWN shall provide the OWNER, its successors and assigns, copies of the inspection findings and a directive to commence with the repairs if necessary.
9. In the event the OWNER, its successors and assigns, fails to maintain the stormwater management facilities in good working condition acceptable to the TOWN, the TOWN may enter upon the Property and take whatever steps necessary to correct deficiencies identified in the inspection report and to charge the costs of such repairs to the OWNER, its successors and assigns. This provision shall not be construed to allow the TOWN to erect any structure of permanent nature on the land of the OWNER outside of the easement for the stormwater management facilities. It is expressly understood and agreed that the TOWN is under no obligation to routinely maintain or repair said facilities, and in no event shall this Agreement be construed to impose any such obligation on the TOWN.
10. The OWNER, its successors and assigns, will perform the work necessary to keep these facilities in good working order as appropriate. The maintenance schedule for the stormwater management facilities outlined on the approved plans will be followed.
11. In the event the TOWN pursuant to this Agreement, performs work of any nature, or expends any funds in performance of said work for labor, use of equipment, supplies, materials, and the like, the OWNER, its successors and assigns, shall reimburse the TOWN upon demand, within thirty (30) days of receipt thereof for all actual costs incurred by the TOWN hereunder.

12. This Agreement imposes no liability of any kind whatsoever on the TOWN and the OWNER agrees to hold the TOWN harmless from any liability in the event the stormwater management facilities fail to operate properly.
13. This agreement shall be recorded in the Monroe County Clerk's Office, together with the deed for the property and shall be included in any approved offering plan and/or prospectus listed in Item 4 above. A copy of the recorded agreement, including evidence of the actual recording(s) shall be provided to the TOWN.
14. The OWNER shall not authorize, undertake or permit alteration, abandonment, modification or discontinuation of the stormwater control measures except in accordance with written approval of the TOWN.
15. The OWNER shall disclose this agreement to a successor or assignee in interest.
16. This agreement is binding upon the OWNER and a successor or assignee in interest in accordance with its terms.
17. This agreement may not be altered except in writing, signed by the TOWN.

WITNESS the following signatures and seals:

Company/Corporation/Partnership Name (Seal)

By: _____

(Type Name)

(Type Title)

STATE OF NEW YORK

TOWN OF _____

The foregoing Agreement was acknowledged before me this ____ day of _____, 20____, by
_____.

NOTARY PUBLIC

My Commission Expires: _____

TOWN of _____, New York

By: _____

(Type Name)

(Type Title)

STATE OF NEW YORK

TOWN OF _____

The foregoing Agreement was acknowledged before me this ____ day of _____, 20____, by
_____.

NOTARY PUBLIC

My Commission Expires: _____

Approved as to Form:

Town of _____ Attorney Date

APPENDIX 7

CONSTRUCTION AND MAINTENANCE COSTS

The following are approximate maintenance and construction costs provided by the Center for Neighborhood Technology. This information is part of the Green Values Stormwater Toolbox, a tool for calculating the relative benefits and costs of different GI approaches, as well as conventional infrastructure approaches, on an individual site.

The tool allows for calculation of cost and benefits based on project location, lot size, percentage of existing land cover types, and size and type of GI practice.

Green Values National Stormwater Management Calculator

Center for Neighborhood Technology

<<http://greenvalues.cnt.org/national/calculator.php>>

Cost Sheet

Component	Construction Cost			Maintenance Cost			Component Lifespan		
	Range	Cost	Source	Range	Cost	Source	Range	Life	Source
Concrete Sidewalk and Driveway	Low	\$3.400/sq ft	RSMeans Building Construction Cost Data - 63rd Annual Edition (2005)	Low	\$0.029/sq ft	City of Oxnard, California, Streets and Waterways Division. "Street Maintenance & Repair Funding." Accessed July 2005	Long	80.0 years	City of Victoria, California, Deptt. Of Engineering Accessed March 2009 Web Link
	Mid	\$5.190/sq ft	RSMeans Site Work & Landscape Cost Data - 28th Annual Edition (2009)	Mid	\$0.029/sq ft	City of Oxnard, California, Streets and Waterways Division. "Street Maintenance & Repair Funding." Accessed July 2005	Mid	40.0 years	Halifax Regional Municipality, Canada; New Design for Asphalt/ Concrete Sidewalks - Information Report Accessed March 2009 Web Link
	High	\$10.000/sq ft	Residential Construction and Remodelling Estimates Accessed March 2009 Web Link	High	\$0.029/sq ft	City of Oxnard, California, Streets and Waterways Division. "Street Maintenance & Repair Funding." Accessed July 2005	Short	30.0 years	PlaNYC 2030 Sustainable Stormwater Management Plan Accessed March 2009 Web Link
Curbs and Gutters	Low	\$13.000/linear foot	"Grassy Swales Fact Sheet." Accessed March 2009 Web Link	Low	\$0.150/linear foot	City of Oxnard, California, Streets and Waterways Division. "Street Maintenance & Repair Funding." Accessed July 2005	Long	80.0 years	City of Victoria, California, Deptt. Of Engineering Accessed March 2009 Web Link
	Mid	\$17.250/linear foot	RSMeans. Building Construction Cost Data. 63rd Annual Edition 2005	Mid	\$0.150/linear foot	City of Oxnard, California, Streets and Waterways Division. "Street Maintenance & Repair Funding." Accessed July 2005	Mid	50.0 years	Average
	High	\$29.500/linear foot	City of Oxnard, California, Streets and Waterways Division. "Street Maintenance & Repair Funding." Accessed July 2005	High	\$0.150/linear foot	City of Oxnard, California, Streets and Waterways Division. "Street Maintenance & Repair Funding." Accessed July 2005	Short	20.0 years	"Grassy Swales Fact Sheet." Accessed March 2009 Web Link
Street	Low	\$2.830/sq ft	Audit of Pavement Standards in the Upper Saluda-Reedy Watershed, Saluda-Reedy Watershed Consortium, 2006 Web Link	Low	\$0.052/sq ft	City of Oxnard, California, Streets and Waterways Division. "Street Maintenance & Repair Funding." Accessed July 2005	Long	50.0 years	City of Oakland, California, Oakland Redevelopment Agency. "Instruction for Project Record Request." Revised July 14, 2005. Web Link
	Mid	\$4.330/sq ft	RSMeans. Site Work and Landscaping Cost Data. 2009	Mid	\$0.055/sq ft	CNT Estimate	Mid	35.0 years	Average

	High	\$12.350/sq ft	City of Oxnard, California, Streets and Waterways Division. "Street Maintenance & Repair Funding." Accessed July 2005	High	\$0.057/sq ft	City of Ventura, California, Public Works and Utilities. "Street Maintenance." Accessed July 2005. Web Link	Short	20.0 years	City of Ventura, California, Public Works and Utilities. "Street Maintenance." Accessed July 2005. Web Link
Parking Lot	Low	\$2.830/sq ft	RSMeans. Site Work and Landscaping Cost Data. 2009.	Low	\$0.080/sq ft	Zimmer Consultants Inc, Illinois; Keeping parking lots on solid ground Retail Traffic Magazine February 1st 1998 Web Link	Long	30.0 years	CHEC Consultant, Civil Engg Services, California; Keeping Parking lots on Solid ground Retail Traffic Magazine February 1st 1998 Web Link
	Mid	\$5.510/sq ft	RSMeans. Site Work and Landscaping Cost Data. 2009.	Mid	\$0.150/sq ft	Pelkonen, Peg. The Morton Arboretum Permeable Parking Lot Presentation at the US Cellular Field Lot L Paver Symposium April 8th, 2008	Mid	20.0 years	Keeping Parking lots on Solid ground Retail Traffic Magazine February 1st 1998 Web Link
	High	\$9.500/sq ft	Rose Paving, email message to CNT, November 13th 2008	High	\$0.650/sq ft	Zimmer Consultants Inc, Illinois; Keeping parking lots on solid ground Retail Traffic Magazine February 1st 1998 Web Link	Short	15.0 years	Pelkonen, Peg. The Morton Arboretum Permeable Parking Lot Presentation at the US Cellular Field Lot L Paver Symposium April 8th, 2008
Conventional Stormwater Storage	Low	\$4.260/cf	RSMeans. Site Work and Landscaping Cost Data. 2009	Low	\$0.015/cf	U.S. Environmental Protection Agency. "Urban Stormwater Best Management Practices Study." EPA-821-R-99-012. August 1999. Web Link	Long	30.0 years	CNT Estimate
	Mid	\$11.550/cf	University of New Hampshire Stormwater Center, Treatment Unit Factsheets, V2B1 Structural Stormwater Treatment System. Accessed March 2009 Web Link	Mid	\$0.030/cf	U.S. Environmental Protection Agency. "Urban Stormwater Best Management Practices Study." EPA-821-R-99-012. August 1999. Web Link	Mid	25.0 years	USEPA Stormwater Technology Factsheet, Onsite Underground Retention/Detention. September 2001 Web Link
	High	\$22.710/cf	USEPA Stormwater Technology Factsheet, Onsite Underground Retention/Detention. September 2001 Web Link	High	\$0.060/cf	U.S. Environmental Protection Agency. "Urban Stormwater Best Management Practices Study." EPA-821-R-99-012. August 1999. Web Link	Short	15.0 years	CNT Estimate

Standard Roof	Low	\$5.080/sq ft	RSMeans. Site Work and Landscaping Cost Data. 2009.	Low	\$0.020/sq ft	CNT Estimate	Long	30.0 years	Partnership for Advancing Technology in Housing. "Improving Durability in Housing: Background Paper." March, 1999 Web Link
	Mid	\$7.500/sq ft	PATH - A Public-Private Partnership for Advancing Housing Technology Accessed March 2009 Web Link	Mid	\$0.050/sq ft	Crawford Roof Maintenance Services - Making a Case for roof Maintenance Web Link	Mid	23.0 years	Average
	High	\$10.000/sq ft		High	\$0.140/sq ft		Short		
			City of Portland, Bureau of Environmental Services Cost Benefit Evaluation of Ecoroofs 2008			RCI, Inc, North Carolina A New Approach to Roof Life Cycle Analysis Accessed March 2009 Web Link		15.0 years	Partnership for Advancing Technology in Housing. "Improving Durability in Housing: Background Paper." March, 1999 Web Link
Green Roof	Low	\$8.750/sq ft	Water Environment Research Federation Low Impact Development Best Management Practices Whole Life Cost Model 2007	Low	\$0.020/sq ft	City of Portland, Bureau of Environmental Services Cost Benefit Evaluation of Ecoroofs 2008	Long	50.0 years	Water Environment Research Federation Low Impact Development Best Management Practices Whole Life Cost Model 2007
	Mid	\$15.750/sq ft	City of Portland, Bureau of Environmental Services Cost Benefit Evaluation of Ecoroofs 2008	Mid	\$0.025/sq ft	Low Impact Development Center, Inc; Low Impact Development for Big Box Manufacturers November 2005 Web Link	Mid	40.0 years	PlaNYC 2030 Sustainable Stormwater Management Plan Accessed March 2009 Web Link
	High	\$31.800/sq ft	Wetland Studies and Solutions, Inc; Virginia LID at WSSI 2007 Web Link	High	\$0.412/sq ft	Water Environment Research Federation Low Impact Development Best Management Practices Whole Life Cost Model 2007	Short	25.0 years	Low Impact Development Center, Inc; Low Impact Development for Big Box Manufacturers November 2005 Web Link
Permeable Pavement-Pavers	Low	\$5.300/sq ft	Sikich, Andrew J. and Patrick D. Kelsey. "The Morton Arboretum's "Green" Parking Lot." Accessed July 2005.	Low	\$0.010/sq ft	Pelkonen, Peg. The Morton Arboretum Permeable Parking Lot Presentation at the US Cellular Field Lot L Paver Symposium April 8th, 2008	Long	50.0 years	Pelkonen, Peg. The Morton Arboretum Permeable Parking Lot Presentation at the US Cellular Field Lot L Paver Symposium April 8th, 2008

	Mid	\$7.100/sq ft	Wetland Studies and Solutions, Inc; Virginia LID at WSSI 2007 Web Link	Mid	\$0.036/sq ft	Southeast Wisconsin Regional Planning Commission. "Costs of Urban Nonpoint Source Water Pollution Control Measures." Technical Report Number 31. June 1991. Web Link	Mid	25.0 years	Low Impact Development Center, Inc; Low Impact Development for Big Box Manufacturers November 2005 Web Link
	High	\$12.000/sq ft	Rose Paving, email message to CNT, November 13th 2008	High	\$0.230/sq ft	Low Impact Development Center, Inc; Low Impact Development for Big Box Manufacturers November 2005 Web Link	Short	15.0 years	U.S. Department of Transportation, Federal Highway Administration. "Stormwater Best Management Practices in an Ultra-Urban Setting: Selection and Monitoring." Accessed July 2005. Web Link
Permeable Pavement - Porous Asphalt	Low	\$5.500/sq ft	Low Impact Development Center, Inc; Low Impact Development for Big Box Manufacturers November 2005 Web Link	Low	\$0.090/sq ft	California Stormwater BMP Handbook; Pervious Pavements Factsheet January 2003 Web Link	Long	40.0 years	Southern California Ready Mix Concrete Association & California Cement Promotion Council Concrete Pavement - Pervious Cost Implications Accessed March 2009 Web Link
	Mid	\$6.340/sq ft	City of Portland, Bureau of Environmental Services, Willamette Watershed Program - Task Memorandum 4.1 August 2005	Mid	\$0.190/sq ft	PlaNYC 2030 Sustainable Stormwater Management Plan Accessed March 2009 Web Link	Mid	25.0 years	Low Impact Development Center, Inc; Low Impact Development for Big Box Manufacturers November 2005 Web Link
	High	\$8.130/sq ft	PlaNYC 2030 Sustainable Stormwater Management Plan Accessed March 2009 Web Link	High	\$0.230/sq ft	Low Impact Development Center, Inc; Low Impact Development for Big Box Manufacturers November 2005 Web Link	Short	20.0 years	City of Portland, Bureau of Environmental Services, Willamette Watershed Program - Task Memorandum 4.1 August 2005
Permeable Pavement - Porous Concrete	Low	\$5.500/sq ft	Low Impact Development Center, Inc; Low Impact Development for Big Box Manufacturers November 2005 Web Link	Low	\$0.090/sq ft	California Stormwater BMP Handbook; Pervious Pavements Factsheet January 2003 Web Link	Long	40.0 years	Southern California Ready Mix Concrete Association & California Cement Promotion Council Concrete Pavement - Pervious Cost Implications Accessed March 2009 Web Link

	Mid	\$6.000/sq ft	Wetland Studies and Solutions, Inc; Virginia LID at WSSI 2007 Web Link	Mid	\$0.160/sq ft	PlaNYC 2030 Sustainable Stormwater Management Plan Accessed March 2009 Web Link	Mid	25.0 years	Low Impact Development Center, Inc; Low Impact Development for Big Box Manufacturers November 2005 Web Link
	High	\$11.600/sq ft	North Carolina Green Building Technology Database; Friday Center Park & Ride Lot, UNC-Chapel Hill Accessed March 2009 Web Link	High	\$0.230/sq ft	Low Impact Development Center, Inc; Low Impact Development for Big Box Manufacturers November 2005 Web Link	Short	20.0 years	PlaNYC 2030 Sustainable Stormwater Management Plan Accessed March 2009 Web Link
Permeable Pavement - Gravel	Low	\$1.720/sq ft	RSMeans Site Work and Landscaping Cost Data. 2009.	Low	\$0.015/sq ft	Center for Neighborhood Technology, Cost for CNT's Gravel Parking Lot Maintenance.	Long	40.0 years	CNT Estimate
	Mid	\$4.320/sq ft	Wetland Studies and Solutions, Inc; Virginia LID at WSSI 2007 Web Link	Mid	\$0.020/sq ft	Minnesota Local Road Research Board To Pave or Not to Pave November 2006 Web Link	Mid	25.0 years	CNT Estimate
	High	\$6.000/sq ft	Wetland Studies and Solutions, Inc; Virginia LID at WSSI 2007 Web Link	High	\$0.050/sq ft	Gravel Roads and Maintenance Design Manual, South Dakota Local Transportation Assistance Program November 2000 Web Link	Short	20.0 years	CNT Estimate
Turf	Low	\$0.010/sq ft	RSMeans Site Work & Landscape Cost Data - 28th Annual Edition (2009)	Low	\$0.020/sq ft	Prairie Restorations, Inc. "Cost Estimates." Accessed March 2009 Web Link	Long	100.0 years	CNT Estimate
	Mid	\$0.210/sq ft	Northern Illinois Planning Commission "Sourcebook on Natural Landscaping for Public Officials." Updated August 2004.	Mid	\$0.090/sq ft	CNT Estimate	Mid	100.0 years	CNT Estimate
	High	\$1.090/sq ft	RSMeans Site Work & Landscape Cost Data - 28th Annual Edition (2009)	High	\$0.140/sq ft	Northern Illinois Planning Commission "Sourcebook on Natural Landscaping for Public Officials." Updated August 2004.	Short	100.0 years	CNT Estimate

Native Plants	Low	\$0.020/sq ft	Prairie Restorations, Inc. "Cost Estimates." Accessed March 2009 Web Link	Low	\$0.030/sq ft	Northern Illinois Planning Commission "Sourcebook on Natural Landscaping for Public Officials." Updated August 2004.	Long	100.0 years	CNT Estimate
	Mid	\$0.100/sq ft	Northern Illinois Planning Commission "Sourcebook on Natural Landscaping for Public Officials." Updated August 2004.	Mid	\$0.050/sq ft	CNT Estimate	Mid	100.0 years	CNT Estimate
	High	\$0.130/sq ft	Northern Illinois Planning Commission "Sourcebook on Natural Landscaping for Public Officials." Updated August 2004.	High	\$0.080/sq ft	Northern Illinois Planning Commission "Sourcebook on Natural Landscaping for Public Officials." Updated August 2004.	Short	100.0 years	CNT Estimate
Rain Garden	Low	\$5.150/sq ft	Water Environment Research Federation Low Impact Development Best Management Practices Whole Life Cost Model 2007 (Self-install)	Low	\$0.310/sq ft	City of Portland, Bereau of Environmental Services, Willamette Watershed Program - Task Memorandum 4.1 August 2005	Long	50.0 years	Seattle Public Utilities, Decentralized Stormwater Control Unit Cost Model November 2008
	Mid	\$7.000/sq ft	Center for Neighborhood Technology, "Green Infrastructure Data Quantification and Assessment on Chicago's Far North Side" Accessed January 2009 Web Link	Mid	\$0.340/sq ft	U.S. Environmental Protection Agency. "Urban Stormwater Best Management Practices Study." EPA-821-R-99-012. August 1999. Web Link	Mid	30.0 years	City of Portland, Bereau of Environmental Services, Willamette Watershed Program - Task Memorandum 4.1 August 2005
	High	\$16.050/sq ft	Water Environment Research Federation Low Impact Development Best Management Practices Whole Life Cost Model 2007 (Professional)	High	\$0.610/sq ft	Low Impact Development Center, Inc; Low Impact Development for Big Box Manufacturers November 2005 Web Link	Short	25.0 years	Low Impact Development Center, Inc; Low Impact Development for Big Box Manufacturers November 2005 Web Link
Trees	Low	\$175.000/each	University of Nebraska-Lincoln, Institute of Agriculture and Natural Resources, Cooperative Extension. "Landscape Tree Appraisal." By David P. Mooter, et.al. G04-1533-A 2004. Web Link	Low	\$20.000/each	Scott, Jessie L. and David R. Betters. "Economic Analysis of Urban Tree Replacement Decisions." Journal of Arboriculture. Volume 26, Number 2. March 2000. Web Link	Long	37.0 years	Moll, G., and Skiera, B. "Trees in the Red." Urban Forests. February/March, 1992. as cited in Natural Resources Defense Council. "Out Of The Gutter, Reducing Polluted Runoff in the District of Columbia." By

APPENDIX 7

Construction and Maintenance Costs

							James W. Woodworth, Jr. July 2002. Web Link
	Mid	\$275.000/each	CNT Estimate	Mid	\$20.000/each	Scott, Jessie L. and David R. Betters. " Economic Analysis of Urban Tree Replacement Decisions." Journal of Arboriculture. Volume 26, Number 2. March 2000. Web Link	Mid 32.0 years Moll, G., and Skiera, B. "Trees in the Red." Urban Forests. February/March, 1992. as cited in Natural Resources Defense Council. "Out Of The Gutter, Reducing Polluted Runoff in the District of Columbia." By James W. Woodworth, Jr. July 2002. Web Link
	High	\$400.000/each	University of Nebraska-Lincoln, Institute of Agriculture and Natural Resources, Cooperative Extension. "Landscape Tree Appraisal." By David P. Mooter, et.al. G04-1533-A 2004. Web Link	High	\$20.000/each	Scott, Jessie L. and David R. Betters. " Economic Analysis of Urban Tree Replacement Decisions." Journal of Arboriculture. Volume 26, Number 2. March 2000. Web Link	Short 13.0 years Moll, G., and Skiera, B. "Trees in the Red." Urban Forests. February/March, 1992. as cited in Natural Resources Defense Council. "Out Of The Gutter, Reducing Polluted Runoff in the District of Columbia." By James W. Woodworth, Jr. July 2002. Web Link
Tree Box Filters	Low	\$69.440/sq ft	University of New Hampshire Stormwater Center, Treatment Unit Factsheets Accessed March 2009	Low	\$2.780/sq ft	Low Impact Development Center, Inc; Low Impact Development for Big Box Manufacturers November 2005 Web Link	Long 50.0 years Water Environment Research Federation Low Impact Development Best Management Practices Whole Life Cost Model 2007
	Mid	\$222.220/sq ft	Water Environment Research Federation Low Impact Development Best Management Practices Whole Life Cost Model 2007	Mid	\$8.690/sq ft	Water Environment Research Federation Low Impact Development Best Management Practices Whole Life Cost Model 2007	Mid 40.0 years CNT Estimate
	High	\$600.000/sq ft	City of Reno, Nevada Virginia Street Treebox filters demonstration project November 2007 Web Link	High	\$13.890/sq ft	Low Impact Development Center, Inc; Low Impact Development for Big Box Manufacturers November 2005 Web Link	Short 25.0 years Low Impact Development Center, Inc; Low Impact Development for Big Box Manufacturers November 2005 Web Link

Bioswales (Parking Lot and Roadside)	Low	\$5.500/sq ft	City of Portland, Bereau of Environmental Services,Willamette Watershed Program - Task Memorandum 4.1 August 2005	Low	\$0.060/sq ft	Costs of Urban Nonpoint Source Water Pollution Control Measures Web Link	Long	50.0 years	Seattle Public Utilities, Decentralized Stormwater Control Unit Cost Model November 2008
	Mid	\$15.000/sq ft	Water Environment Research Federation Low Impact Development Best Management Practices Whole Life Cost Model 2007	Mid	\$0.120/sq ft	Water Environment Research Federation Low Impact Development Best Management Practices Whole Life Cost Model 2007	Mid	30.0 years	City of Portland, Bereau of Environmental Services,Willamette Watershed Program - Task Memorandum 4.1 August 2005
	High	\$24.000/sq ft	Center for Neighborhood Technology, "Green Infrastructure Data Quantification and Assessment In the Calumet Region" Accessed January 2009 Web Link	High	\$0.210/sq ft	City of Portland, Bereau of Environmental Services,Willamette Watershed Program - Task Memorandum 4.1 August 2005	Short	20.0 years	PlaNYC 2030 Sustainable Stormwater Management Plan Accessed March 2009 Web Link
Downspout Disconnection	Low	\$9.000/downspout	Southwest Florida Water Management District, Downspout Diconnection Report Accessed March 2009 Web Link	Low	\$0.000/downspout	City of Portland, Bereau of Environmental Services,Willamette Watershed Program - Task Memorandum 4.1 August 2005	Long	100.0 years	Seattle Public Utilities, Decentralized Stormwater Control Unit Cost Model November 2008
	Mid	\$35.000/downspout	Milwaukee Metropolitan Sewerage District Stormwater Runoff Reduction Program December 2005	Mid	\$0.250/downspout	Seattle Public Utilities, Decentralized Stormwater Control Unit Cost Model November 2008	Mid	50.0 years	CNT Estimate
	High	\$156.000/downspout	Milwaukee Metropolitan Sewerage District Stormwater Runoff Reduction Program December 2005	High	\$0.250/downspout	Seattle Public Utilities, Decentralized Stormwater Control Unit Cost Model November 2008	Short	30.0 years	City of Portland, Bereau of Environmental Services, Downspout Disconnection Factsheet July 2006 Web Link
Planter Boxes	Low	\$0.550/sq ft	New York Stormwater Management Design Manual Accessed March 2009 Web Link	Low	\$0.040/sq ft	New York Stormwater Management Design Manual Accessed March 2009 Web Link	Long	30.0 years	CNT Estimate
	Mid	\$8.000/sq ft	Low Impact Development Center, Inc; Low Impact Development for Big Box Manufacturers November 2005 Web Link	Mid	\$0.800/sq ft	Low Impact Development Center, Inc; Low Impact Development for Big Box Manufacturers November 2005 Web Link	Mid	25.0 years	Low Impact Development Center, Inc; Low Impact Development for Big Box Manufacturers November 2005 Web Link

	High	\$24.520/sq ft	PlaNYC 2030 Sustainable Stormwater Management Plan Accessed March 2009 Web Link	High	\$1.000/sq ft	Charles River Watershed Association, Low Impact Best Management Practice (BMP) Information Sheet September 2008 Web Link	Short	20.0 years	PlaNYC 2030 Sustainable Stormwater Management Plan Accessed March 2009 Web Link
Rain Barrels	Low	\$0.720/gallon	Metropolitan Water Reclamation District of Greater Chicago Accessed March 2009 Web Link	Low	\$0.000/gallon	PlaNYC 2030 Sustainable Stormwater Management Plan Accessed March 2009 Web Link	Long	20.0 years	PlaNYC 2030 Sustainable Stormwater Management Plan Accessed March 2009 Web Link
	Mid	\$1.090/gallon	Milwaukee Metropolitan Sewerage District Stormwater Runoff Reduction Program December 2005	Mid	\$0.000/gallon	PlaNYC 2030 Sustainable Stormwater Management Plan Accessed March 2009 Web Link	Mid	20.0 years	PlaNYC 2030 Sustainable Stormwater Management Plan Accessed March 2009 Web Link
	High	\$2.540/gallon	Milwaukee Metropolitan Sewerage District Stormwater Runoff Reduction Program December 2005	High	\$0.000/gallon	PlaNYC 2030 Sustainable Stormwater Management Plan Accessed March 2009 Web Link	Short	20.0 years	PlaNYC 2030 Sustainable Stormwater Management Plan Accessed March 2009 Web Link
Cisterns	Low	\$0.610/gallon	Low Impact Development Center, Inc; Low Impact Development for Big Box Manufacturers November 2005 Web Link	Low	\$0.000/gallon	PlaNYC 2030 Sustainable Stormwater Management Plan Accessed March 2009 Web Link	Long	50.0 years	City of Portland, Bureau of Environmental Services, Cisterns Factsheet July 2006 Web Link
	Mid	\$1.450/gallon	Water Environment Research Federation Low Impact Development Best Management Practices Whole Life Cost Model 2007	Mid	\$0.070/gallon	Water Environment Research Federation Low Impact Development Best Management Practices Whole Life Cost Model 2007	Mid	25.0 years	Seattle Public Utilities, Decentralized Stormwater Control Unit Cost Model November 2008
	High	\$2.880/gallon	Wetland Studies and Solutions, Inc; Virginia LID at WSSI 2007	High	\$0.070/gallon	Water Environment Research Federation Low Impact Development Best Management Practices Whole Life Cost Model 2007	Short	20.0 years	PlaNYC 2030 Sustainable Stormwater Management Plan Accessed March 2009 Web Link
Vegetated Filter Strips	Low	\$0.030/ sq ft	USEPA, Office of Water National Management Measures to Control Non Point Source Pollution from Urban Areas November 2005 Web Link	Low	\$0.070/ sq ft	Low Impact Development Center, Inc; Low Impact Development for Big Box Manufacturers November 2005 Web Link	Long	50.0 years	CNT Estimate

	Mid	\$1.450/ sq ft	USEPA, Office of Water National Management Measures to Control Non Point Source Pollution from Urban Areas November 2005 Web Link	Mid	\$0.070/ sq ft	Low Impact Development Center, Inc; Low Impact Development for Big Box Manufacturers November 2005 Web Link	Mid	25.0 years	Low Impact Development Center, Inc; Low Impact Development for Big Box Manufacturers November 2005 Web Link
	High	\$3.330/ sq ft	Low Impact Development Center, Inc; Low Impact Development for Big Box Manufacturers November 2005 Web Link	High	\$0.070/ sq ft	Low Impact Development Center, Inc; Low Impact Development for Big Box Manufacturers November 2005 Web Link	Short	20.0 years	CNT Estimate
Amended Soil	Low	\$15.000/ cubic yard	Low Impact Development Center, Inc; Low Impact Development for Big Box Manufacturers November 2005 Web Link	Low	\$0.023/ cubic yard	City of Virginia, Fairfax County; LID BMP Factsheet - Soil Amendments Febraury 2005 Web Link	Long	50.0 years	CNT Estimate
	Mid	\$30.000/ cubic yard	Water Environment Research Federation Low Impact Development Best Management Practices Whole Life Cost Model 2007	Mid	\$0.023/ cubic yard	City of Virginia, Fairfax County; LID BMP Factsheet - Soil Amendments Febraury 2006 Web Link	Mid	30.0 years	CNT Estimate
	High	\$60.000/ cubic yard	Low Impact Development Center, Inc; Low Imoact Development for Big Box Manufacturers Web Link	High	\$0.023/ cubic yard	City of Virginia, Fairfax County; LID BMP Factsheet - Soil Amendments Febraury 2006 Web Link	Short	25.0 years	City of Virginia, Fairfax County; LID BMP Factsheet - Soil Amendments Febraury 2005 Web Link

APPENDIX 8

RECOMMENDED PLANTS FOR GI PRACTICES

The NYS SMDM provides a list of recommended plants for GI. This list is included below.

The NYS SMDM plant list contains information about hydrologic zones - from plants that thrive under permanently inundated conditions to upland plants that are seldom or never inundated. The following table from the NYS SMDM provides more information about hydrologic conditions.

The NYS SMDM only includes native plants. Native plants provide food and habitat for wildlife including songbirds,

<u>Zone #</u>	<u>Zone Description</u>	<u>Hydrologic Conditions</u>
Zone 1	Deep Water Pool	1-6 feet deep Permanent Pool
Zone 2	Shallow Water Bench	6 inches to 1 foot deep
Zone 3	Shoreline Fringe	Regularly inundated
Zone 4	Riparian Fringe	Periodically inundated
Zone 5	Floodplain Terrace	Infrequently inundated
Zone 6	Upland Slopes	Seldom or never inundated



butterflies, and pollinators. Incorporating native plants in GI projects can benefit wildlife, increasing the resiliency of local ecological communities. A summary of wildlife benefits for each plant is included in the NYS SMDM and in the table below.

Native plants should be prioritized when selecting plants for GI practices, however, there are additional factors to consider. Conditions within GI practices can be very different than local conditions in less constructed areas. Plants may need to be able to tolerate circumstances such as high salinity or more pronounced droughts.

Some GI practices, such as riparian buffers, are attempts to recreate native ecologies. These practices should use natives exclusively.

Other practices may include difficult conditions for many native plants, such as extensive green roof projects, and may rely heavily on non-native plants. Most GI practices will fall in the middle of this spectrum, and will need to be considered on a case by case basis.

When using non-native species, it is critical to make certain that they are not invasive. Plants included in the NYS Prohibited and Regulated Invasive Plants list should not be used in GI practices.

http://www.dec.ny.gov/docs/lands_forests_pdf/isprohibitedplants2.pdf

This list includes many plants that have been historically used in landscape designs, such as Barberry, Multiflora Rose, Sycamore Maple, and Burning Bush, so it is important that individuals who design GI and other landscape projects familiarize themselves with this document.

It is also important to note that there are many plants that have both native and non-native varieties. For example, the NYS SMDM plant list includes Cattails (*Typha* spp.). However, Broadleaf Cattail (*Typha latifolia*) is a native plant, while Narrowleaf Cattail (*Typha angustifolia*) is potentially invasive **https://plants.usda.gov/plantguide/pdf/cs_tyan.pdf**.

The table below is a convenient starting point for GI plant selection. This table can be supplemented using online resources for plant images, for more information about ideal growing conditions, and to select additional species.

The Cornell Woody Plants Database is a well developed local resource for trees and shrubs.

< <http://woodyplants.cals.cornell.edu/home> >

The Lady Bird Johnson Native Plant Database provides extensive information about native plants, including wildlife benefits, and has a search function for finding local nurseries that carry native stock.

< <http://www.wildflower.org/> >

The Chicago Botanic Garden Plant Finder is a useful general resource for looking up cultivated plants, their growing conditions, appearance, best uses, and maintenance needs.

< <http://www.chicagobotanic.org/plantcollections#plantfinder> >

RECOMMENDED PLANTS FOR GI PRACTICES

Plant Name	Zone	Form	Available	Inundation Tolerance	Wildlife Value	Notes
American Elm (<i>Ulmus americana</i>)	4,5,6	Dec. Tree	yes	Irregular seasonal saturation	High. Food (seeds,browsing), cover, nesting for birds & mammals	Susceptible to disease (short-lived) Sun to full shade, tolerates drought and wind/ice damage.
Arrowwood Viburnum (<i>Viburnum dentatum</i>)	3, 4	Dec. Shrub	yes	yes	High. Songbirds and mammals	Grows best in partial shade
Bald Cypress (<i>Taxodium distichum</i>)	3, 4	Dec. Tree	yes	yes	Little food value, but good perching site for waterfowl	Forested Coastal Plain. North of normal range. Tolerates drought.
Bayberry (<i>Myrica pensylvanica</i>)	4, 5, 6	Dec. Shrub	yes	yes	High. Nesting, food, cover. Berries last into winter	Coastal Plain only. Roots fix N2 Tolerates slightly acidic soils.
Black Ash (<i>Fraxinus nigra</i>)	3,4,5	Dec. Tree	yes	Irregular seasonal saturation	High. Food (seeds, sap), cover, nesting for birds & mammals. Fruit persists in winter	Rapid growth. Requires full sun. Susceptible to wind/ice damage & disease. Tolerates drought and infrequent flooding by salt water.
Black Cherry (<i>Prunus serotina</i>)	5,6	Dec. Tree	yes	no	High. Food	Moist soils or wet bottomland areas
Blackgum or Sourgum (<i>Nyssa sylvatica</i>)	4,5,6	Dec. Tree	yes	yes	High. Songbirds, egrets, herons, raccoons, owls	Can be difficult to transplant. Prefers sun to partial shade
Black Willow (<i>Salix nigra</i>)	3,4,5	Dec. Tree	yes	yes	High. Browsing and cavity nesters.	Rapid growth, stabilizes streambanks. Full sun
Buttonbush (<i>Cephalanthus occidentalis</i>)	2,3, 4,5	Dec. Shrub	yes	yes	High. Ducks and shorebirds. Seeds, nectar and nesting.	Full sun to partial shade. Will grow in dry areas.
Common Spice Bush (<i>Lindera benzoin</i>)	3,4,5	Dec. Shrub	yes	yes	Very high. Songbirds	Shade and rich soils. Tolerates acidic soils. Good understory species
Eastern Cottonwood (<i>Populus deltoides</i>)	4,5	Dec. Tree	yes	yes	Moderate. Cover, food.	Shallow rooted, subject to windthrow. Invasive roots. Rapid growth.

Plant Name	Zone	Form	Available	Inundation Tolerance	Wildlife Value	Notes
<i>Eastern Hemlock (Tsuga canadensis)</i>	5,6	Conif. Tree	yes	yes	Moderate. Mostly cover and some food	Tolerates all sun/shade conditions. Tolerates acidic soil.
<i>Eastern Red Cedar (Juniperus virginiana)</i>	4,5,6	Conif. Tree	yes	no	High. Fruit for birds. Some cover.	Full sun to partial shade. Common in wetlands, shrub bogs and edge of stream
<i>Elderberry (Sambucus canadensis)</i>	3,4, 5,6	Dec. Shrub	yes	yes	Extremely high. Food and cover, birds and mammals.	Full sun to partial shade.
<i>Green Ash, Red Ash (Fraxinus pennsylvanica)</i>	4,5	Dec. Tree	yes	yes	Moderate. Songbirds.	Rapid growing streambank stabilizer. Full sun to partial shade.
<i>Hackberry (Celtis occidentalis)</i>	5,6	Dec. Tree	yes	some	High. Food and cover	Full sun to partial shade.
<i>Larch, Tamarack (Larix laricina)</i>	3,4	Conif. Tree	no	yes	Low. Nest tree and seeds.	Rapid initial growth. Full sun, acidic boggy soil.
<i>Pin Oak (Quercus palustris)</i>	3,4,5,6	Dec. Tree	yes	yes	High. Tolerates acidic soil	Gypsy moth target. Prefers well drained, sandy soils.
<i>Red Choke Berry (Pyrus arbutifolia)</i>	3,4,5	Dec. Shrub	no	yes	Moderate. Songbirds.	Bank stabilizer. Partial sun.
<i>Red Maple (Acer rubrum)</i>	3,4, 5,6	Dec. Tree	yes	yes	High seeds and browse. Tolerates acidic soil.	Rapid growth.
<i>River Birch (Betula nigra)</i>	3,4,5	Dec. Tree	yes	yes	Low. Good for cavity nesters	Bank erosion control. Full sun.
<i>Shadowbush, Serviceberry (Amelanchier canadensis)</i>	4,5,6	Dec. Tree	yes	yes	High. Nesting, cover, food. Birds and mammals.	Prefers partial shade. Common in forested wetlands and upland woods.
<i>Silky Dogwood (Cornus amomium)</i>	3,4,5	Dec. Shrub	yes	yes	High. Songbirds, mammals.	Shade and drought tolerant. Good bank stabilizer.
<i>Slippery Elm (Ulmus rubra)</i>	3,4,5	Dec. Tree	rare	yes	High. Food (seeds, buds) for birds & mammals (browse). Nesting	Rapid growth, no salinity tolerance. Tolerant to shade and drought.
<i>Smooth Alder (Alnus serrulata)</i>	3,4,5	Dec. Tree	no	yes	High. Food, cover.	Rapid growth. Stabilizes streambanks.

APPENDIX 8

Recommended Plants for GI Practices

Plant Name	Zone	Form	Available	Inundation Tolerance	Wildlife Value	Notes
<i>Speckled Alder (Alnus rugosa)</i>	3,4	Dec. Shrub	yes	yes	High. Cover, browse for deer, seeds for bird.	
<i>Swamp White Oak (Quercus bicolor)</i>	3,4,5	Dec. Tree	yes	yes	High. Mast	Full sun to partial shade. Good bottomland tree.
<i>Swamp Rose (Rosa Palustris)</i>	3,4	Dec. Shrub		Irregular, seasonal, or regularly saturated	High. Food (hips) for birds including turkey, ruffed grouse and mammals. Fox cover.	Prefers full sun. Easy to establish. Low salt tolerance.
<i>Sweetgum (Liquidambar styraciflua)</i>	4,5,6	Dec. Tree	yes	yes	Moderate. Songbirds	Tolerates acid or clay soils. Sun to partial shade.
<i>Sycamore (Platanus occidentalis)</i>	4,5,6	Dec. Tree	yes	yes	Low. Food, cavities for nesting.	Rapid growth. Common in floodplains and alluvial woodlands.
<i>Tulip Tree (Liriodendron tulipifera)</i>	5,6	Dec. Tree	yes	no	Moderate. Seeds and nest sites	Full sun to partial shade. Well drained soils. Rapid growth.
<i>Tupelo (Nyssa sylvatica v biflora)</i>	3,4,5	Dec. Tree	yes	yes	High. Seeds and nest sites	Ornamental
<i>White Ash (Fraxinus americana)</i>	5,6	Dec. Tree	yes	no	High. Food	All sunlight conditions. Well drained soils.
<i>Winterberry (Ilex verticillata)</i>	3,4,5	Dec. Shrub	yes	yes	High. Cover and fruit for birds. Holds berries into winter.	Full sun to partial shade. Seasonally flooded areas.
<i>Witch Hazel (Hamamelis virginiana)</i>	4,5	Dec. Shrub	yes	no	Low. Food for squirrels, deer, and ruffed grouse.	Prefers shade. Ornamental.

Plant Name	Zone	Form	Available	Inundation Tolerance	Wildlife Value	Notes
<i>Arrow arum (Peltandra virginica)</i>	2,3	Emergent	yes	up to 1 ft.	High. Berries are eaten by wood ducks.	Full sun to partial shade.
<i>Arrowhead, Duck Potato (Sagittaria latifolia)</i>	2,3	Emergent	yes	up to 1 ft.	Moderate. Tubers and seeds eaten by ducks.	Aggressive colonizer.
<i>Big Bluestem (Andropogon gerardi)</i>	4,5	Perimeter	yes	Irregular or seasonal inundation.	High. Seeds for songbirds. Food for deer	Requires full sun.
<i>Birdfoot deervetch (Lotus Corniculatus)</i>	4,5,6	Perimeter	yes	Infrequent inundation	High. Food for birds.	Full sun. Nitrogen fixer.
<i>Blue Flag Iris (Iris versicolor)</i>	2,3	Emergent	yes	Regular or permanently, up to ½ ft or saturated	Moderate. Food muskrat and wildfowl. Cover, marshbirds	Slow growth. Full sun to partial shade. Tolerates clay. Fresh to moderately brackish water.
<i>Blue Joint (Calamagrotis canadensis)</i>	2,3,4	Emergent	yes	Regular or permanent inundation up to 0.5 ft.	Moderate. Food for game birds and moose.	Tolerates partial shade
<i>Broomsedge (Andropogon virginicus)</i>	2,3	Perimeter	yes	up to 3 in.	High. Songbirds and browsers. Winter food and cover	Tolerant of fluctuation water levels & partial shade.
<i>Bushy Beardgrass (Andropogon glomeratus)</i>	2,3	Emergent	yes	up to 1 ft.		Requires full sun.
<i>Cardinal flower (Lobelia cardinalis)</i>	4,5,6	Perimeter	yes	Some. Tolerates saturation up to 100% of season.	High. Nectar for hummingbird, oriole, butterflies.	Tolerates partial shade
<i>Cattail (Typha sp.)</i>	2,3	Emergent	yes	up to 1 ft.	Low. Except as cover	Aggressive. May eliminate other species. Volunteer. High pollutant treatment.
<i>Coontail (Ceratophyllum demersum)</i>	1	Submergent	no	yes	Low food value. Good habitat and shelter for fish and invertebrates.	Free floating SAV. Shade tolerant. Rapid growth.

Plant Name	Zone	Form	Available	Inundation Tolerance	Wildlife Value	Notes
<i>Common Three-Square (Scirpus pungens)</i>	2	Emergent	yes	up to 6 in.	High. Seeds, cover. Waterfowl and fish.	High metal removal.
<i>Duckweed (Lemma sp.)</i>	1,2	Submergent/ Emergent	yes	yes	High. Food for waterfowl and fish.	High metal removal.
<i>Fowl mannagrass (Glyceria striata)</i>	4,5	Perimeter	yes	Irregular or seasonal inundation	High. Food for waterfowl, muskrat, and deer.	Partial to full shade
<i>Hardstem Bulrush (Scirpus acutus)</i>	2	Emergent	yes	up to 3 ft.	High. Cover, food (achenes, rhizomes) ducks, geese, muskrat, fish. Nesting for bluegill and bass.	Quick to establish, fresh to brackish. Good for sediment stabilization and erosion control.
<i>Giant Burreed (Sparganium eurycarpum)</i>	2,3	Emergent	rare	Regular to permanently inundated. up to 1 ft.	High. Food (seeds, plant) waterfowl, beaver & other mammals. Cover for marshbirds, waterfowl.	Rapid spreading . Tolerates partial sun. Good for shoreline stabilization. Salinity <0.5 ppt
<i>Lizard's Tail (Saururus cernuus)</i>	2	Emergent	yes	up to 1 ft.	Low, except wood ducks.	Rapid growth. Shade tolerant
<i>Long-leaved Pond Weed (Potamogeton nodosus)</i>	1,2	Rooted, submerged aquatic	yes	up to 1-6 ft. depending on turbidity	High. Food (seeds, roots) waterfowl, aquatic furbearers, deer, moose. Habitat for fish	Rapid spread. Salinity <0.5 ppt. Flowers float on surface, Aug.- Sept.
<i>Marsh Hibiscus (Hibiscus moscheutos)</i>	2,3	Emergent	yes	up to 3 in.	Low. Nectar.	Full sun. Can tolerate periodic dryness.
<i>Pickeralweed (Pontederia cordata)</i>	2,3	Emergent	yes	up to 1 ft.	Moderate. Ducks. Nectar for butterflies.	Full sun to partial shade.
<i>Pond Weed, Sago (Potamogeton pectinatus)</i>	1	Submergent	yes	yes	Extremely high. Waterfowl, marsh and shorebirds.	Removes heavy metals.
<i>Redtop (Agrostis alba)</i>	3,4,5	Perimeter	yes	Up to 25% of season	Moderate. Rabbits and some birds.	Quickly established but not highly competitive
<i>Rice Cutgrass (Leersia oryzoides)</i>	2,3	Emergent	yes	up to 3 in.	High. Food and cover.	Full sun although tolerant of shade. Shoreline stabilization.

APPENDIX 8

Recommended Plants for GI Practices

Plant Name	Zone	Form	Available	Inundation Tolerance	Wildlife Value	Notes
<i>Sedges (Carex spp.)</i>	2,3	<i>Emergent</i>	<i>yes</i>	<i>up to 3 in.</i>	<i>High waterfowl, songbirds.</i>	<i>Many wetland and upland species.</i>
<i>Tufted Hairgrass (Deschampsia caespitosa)</i>	3,4,5	<i>Perimeter</i>	<i>yes</i>	<i>Regular to irregular inundation.</i>	<i>High.</i>	<i>Full sun. May become invasive.</i>
<i>Soft-stem Bulrush (Scirpus validus)</i>	2,3	<i>Emergent</i>	<i>yes</i>	<i>up to 1 ft.</i>	<i>Moderate. Good cover and food.</i>	<i>Full sun. Aggressive colonizer. High pollutant removal.</i>
<i>Smartweed (Polygonum spp.)</i>	2,3,4	<i>Emergent</i>	<i>yes</i>	<i>up to 1 ft.</i>	<i>High. Waterfowl, songbirds. Seeds and cover.</i>	<i>Fast colonizer. Avoid weedy aliens such as P. perfoliatum.</i>
<i>Soft Rush (Juncus effusus)</i>	2,3,4	<i>Emergent</i>	<i>yes</i>	<i>up to 3 in.</i>	<i>Moderate.</i>	<i>Tolerates wet or dry conditions.</i>
<i>Spatterdock (Nuphar luteum)</i>	2	<i>Emergent</i>	<i>yes</i>	<i>up to 3 ft.</i>	<i>Moderate for food but high for cover.</i>	<i>Fast colonizer. Tolerant of fluctuating water levels.</i>
<i>Switchgrass (Panicum virgatum)</i>	2,3,4 5,6	<i>Perimeter</i>	<i>yes</i>	<i>up to 3 in.</i>	<i>High. Seeds, cover for waterfowl, songbirds</i>	<i>Tolerates wet/dry conditions.</i>
<i>Sweet Flag (Acorus calamus)</i>	2,3	<i>Herbaceous</i>	<i>yes</i>	<i>up to 3 in.</i>	<i>Low.</i>	<i>Tolerant of dry periods. Not a rapid colonizer. Tolerates acidic conditions.</i>
<i>Waterweed (Elodea canadensis)</i>	1	<i>Submergent</i>	<i>yes</i>	<i>yes</i>	<i>Low.</i>	<i>Good water oxygenator. High nutrient, copper, manganese and chromium removal.</i>
<i>Wild Celery (Valisneria americana)</i>	1	<i>Submergent</i>	<i>yes</i>	<i>yes</i>	<i>High. Food for waterfowl. Habitat for fish and invertebrates.</i>	<i>Tolerant of murky water and high nutrient loads.</i>
<i>Wild Rice (Zizania aquatica)</i>	2	<i>Emergent</i>	<i>yes</i>	<i>up to 1 ft.</i>	<i>High. Food for birds.</i>	<i>Prefers full sun</i>
<i>Wool Grass (Scirpus cyperinus)</i>	2,3	<i>Emergent</i>	<i>yes</i>	<i>Irregularly to seasonally inundated</i>	<i>Moderate. Cover, Food.</i>	<i>Requires full sun. Can tolerate acidic soils, drought. Colonizes disturbed areas, moderate growth.</i>

APPENDIX 8

Recommended Plants for GI Practices

VISUAL GUIDE - 'TOP 20' PLANT SPECIES FOR GREEN INFRASTRUCTURE

The following is a collection of twenty native species commonly used in GI practices. These species were selected for their performance in GI retrofit practices in Monroe County, as well as their aesthetic qualities. However, these are just a small sample of the many species that can thrive in GI projects in Monroe County. It is important to use a wide variety of plants in GI practices, to maximize ecosystem services and ensure landscape resilience.



Smooth Alder - Alnus serrulata



Sweetgum - Liquidambar styraciflua



Swamp White Oak - Quercus bicolor



Serviceberry - Amelanchier canadensis



River Birch - Betula nigra



Red Maple - Acer rubrum



Buttonbush- *Cephalanthus occidentalis*



Common Spice Bush - *Lindera benzoin*



Arrowwood Viburnum - *Viburnum dentatum*



Gro Low Fragrant Sumac - *Rhus aromatica*



Redstem Dogwood - *Cornus sericea*



Witch Hazel - *Hamamelis virginiana*

APPENDIX 8

Recommended Plants for GI Practices



Cardinal Flower - Lobelia cardinalis



Blue Flag Iris - Iris versicolor



Switchgrass - Panicum virgatum



Tufted Hairgrass - Deschampsia caespitosa



Pennsylvania Sedge - Carex pensylvanica



Soft Rush - Juncus effusus



Purple Coneflower - Echinacea purpurea



Black Eyed Susan - Rudbeckia fulgida

APPENDIX 9

GREEN INFRASTRUCTURE FUNDING SOURCES

This Appendix identifies the numerous sources which can be used to provide monetary assistance for GI. Over the past decade there has been an increased interest in sustainability and resilient communities. Many federal and state funding programs have responded by expanding eligible activities to include GI. In addition, because GI practices have benefits beyond stormwater, programs targeted toward other issues, such as economic development, may fund GI projects.

Several programs are particularly compatible with a wide range of GI projects, including the Green Innovation Grant Program, Water Quality Improvement Program, and Community Development Block Grant Program.

The following quick reference table is organized by funding source (federal, state, or private grants). Many of these grants are targeted toward specific GI practices, such as tree planting or stream daylighting - notes about what type of projects are applicable are included in the Relevant Project Types section of the table.

ONLINE RESOURCES

Funding opportunities are always changing. Luckily, several government websites keep track of ongoing funding for GI. For an up-to-date list of federal GI funding sources, please see the following websites:

Environmental Protection Agency:

<<https://ofmpub.epa.gov/apex/watershedfunding/f?p=fedfund:1>>

Department of Environmental Conservation

<<http://www.dec.ny.gov/chemical/108961.html>>

Catalog of Federal Domestic Assistance

<https://www.cfda.gov/index?s=program&tab=list&mode=list&clear_search=1>

In addition the EPA provides a strategic guide, 'Getting to Green, Paying for Green Infrastructure, Financing Options and Resources for Local Decision Makers'

<https://www.epa.gov/sites/production/files/2015-02/documents/gi_financing_options_12-2014_4.pdf>

FEDERAL FUNDING SOURCES

Grant Name	Funding Source	Relevant Project Types
Community Development Block Grant (CDBG) Entitlement Program	Department of Housing and Urban Development (HUD)	Public facilities and improvements, such as streets, sidewalks, sewers, water systems, community and senior citizen centers, recreational facilities, and greenways https://www.hudexchange.info/programs/cdbg-entitlement/
Section 108 Loan Guarantee Program	Department of Housing and Urban Development (HUD)	The Section 108 Loan Guarantee Program allows future CDBG allocations to be used to guarantee loans for neighborhood revitalization projects, including construction and installation of public facilities and infrastructure. Section 108-guaranteed projects can incorporate GI into their design and construction https://business.usa.gov/program/section-108-loan-guarantee-program
National Urban and Community Forestry Program	US Department of Agriculture (USDA)	Urban forestry, tree planting https://fs.fed.us/managing-land/urban-forests/ucf
Economic Development Assistance Programs	US Economic Development Administration (EDA)	Grants and cooperative agreements made under these programs are designed to leverage existing regional assets and support the implementation of economic development strategies that advance new ideas and creative approaches to advance economic prosperity in distressed communities. EDA provides strategic investments on a competitive- merit-basis to support economic development, foster job creation, and attract private investment in economically distressed areas of the United States. https://www.eda.gov/funding-opportunities/
Public Works and Development Facilities Program	US Economic Development Administration (EDA)	Infrastructure improvements for distressed communities http://www.grants.gov/web/grants/view-opportunity.html?oppld=290874
Pre-Disaster Mitigation Program	Federal Emergency Management Agency	Flood prevention through stormwater management https://www.fema.gov/pre-disaster-mitigation-grant-program

<i>Grant Name</i>	<i>Funding Source</i>	<i>Relevant Project Types</i>
Clean Water State Revolving Fund (CWSRF)	US Environmental Protection Agency (EPA)	Wastewater treatment, Green infrastructure Stormwater management, Non-point source pollution control, and Watershed and estuary management. <i>https://www.epa.gov/cwsrf</i>
Great Lakes Restoration Initiative Urban Watershed Management Implementation	US Environmental Protection Agency (EPA)	Non-point Source Pollution Impacts on Near-shore Health <i>https://www.epa.gov/great-lakes-funding/great-lakes-restoration-initiative-glri</i>
Urban Waters Small Grants	US Environmental Protection Agency (EPA)	Urban Waters Small Grants seek to help restore and protect urban water quality and revitalize adjacent neighborhoods by engaging communities in activities that increase their connection to, understanding of, and stewardship of local urban waterways. <i>https://www.epa.gov/urbanwaters/urban-waters-small-grants</i>
Wetland Program Development Grants	US Environmental Protection Agency (EPA)	Wetland creation and restoration, prevention and reduction of water pollution <i>https://www.epa.gov/wetlands/wetland-program-development-grants</i>
Science to Achieve Results	US Environmental Protection Agency (EPA)	Stormwater Management Approaches Using Green Infrastructure, Monitoring and Evidence Based Design <i>https://www.epa.gov/research-fellowships/science-achieve-results-star-graduate-fellowships</i>

NEW YORK STATE & PRIVATE FUNDING SOURCES

Grant Name	Funding Source	Relevant Project Types
CFA (Consolidated Funding Application)	Various NY State Agencies	See Below https://apps.cio.ny.gov/apps/cfa/
Green Innovation Grant Program	NYS Environmental Facilities Corp. (Through CFA)	Permeable pavement bioretention systems Stormwater planters green roofs Urban forestry riparian buffers Floodplain restoration constructed wetlands Stream daylighting https://www.efc.ny.gov/Default.aspx?tabid=461
Community Development Block Grants - Public Infrastructure	Office of Community Renewal (OCR) NYS Housing Trust Fund Corporation (HTFC) through CFA	Flood control, stormwater drainage Stormwater retrofit projects - low income populations https://portal.hud.gov/hudportal/HUD?src=/program_offices/comm_planning/communitydevelopment/programs
Local Waterfront Revitalization Program	NYS Dept. of State through CFA	Preparation or Implementation of a Local Waterfront Revitalization Program, Redeveloping hamlets, downtowns, urban waterfronts. https://www.dos.ny.gov/opd/programs/lwrp.html
Cleaner Greener Communities	NYS Energy Research and Development Authority through CFA	Large-scale sustainability projects that support energy efficiency, renewable energy, or carbon mitigation https://apps.cio.ny.gov/apps/cfa/
Empire State Development Grants - Infrastructure	NYS Urban Development Corporation (UDC) & NYS Job Development Authority (JDA) through CFA	GI practices as part of downtown/streetscape revitalization https://esd.ny.gov/businessprograms/econdevpurposesgrants.html

Grant Name	Funding Source	Relevant Project Types
New York Main Street Program	NYS Office of Community Renewal through CFA	GI practices as part of downtown/streetscape revitalization http://www.nyshcr.org/Programs/NYMainStreet/
Environmental Protection Fund Municipal Grant Program	Office of Parks, Recreation, and Historic Preservation through CFA	Acquisition of parkland or restoration of land/water http://www.dec.ny.gov/about/92815.html
Water Quality Improvement Program (WQIP)	NYS Department of Environmental Conservation (DEC)	Stormwater Retrofits Green Infrastructure Stream Stabilization/Restoration, and Other Non-point Source Best Management Practices (BMPs) Upgrade and replacement of road stream crossing structures (culverts and bridges) Rehabilitation of road stream crossings Installation of fish ladders Removal or breach of stream barriers Stream daylighting http://www.dec.ny.gov/pubs/4774.html
Urban and Community Forestry Program	NYS Department of Environmental Conservation (DEC)	Tree plantings on public property https://fs.fed.us/managing-land/urban-forests/ucf
Environmental Justice Community Impact Grant Program	NYS Department of Environmental Conservation	GI practices combined with education, stewardship, or monitoring activities in areas with multiple environmental risks http://www.dec.ny.gov/public/31226.html
American ReLeaf Program	Private	Tree Planting http://www.americanforests.org/discover-american-forests/our-work/
The Conservation Alliance Fund	Private	Land Use http://www.conservationalliance.com/grants/
Surdna Environment/Community Revitalization	Private	Community revitalization and environment, www.surdna.org/grants/grants-overview.html

APPENDIX 10

GREEN INFRASTRUCTURE SAMPLE PLANS, CROSS SECTIONS AND DETAILS

The following are sample GI plans, cross sections and details provided by the NYC Department of Environmental Protection. These are provided as samples only. All GI practices should be designed based on specific site conditions by a qualified professional. More sample construction details from the NYC Department of Environmental Protection are available at:

<http://www.nyc.gov/html/dep/pdf/green_infrastructure/bioswales-standard-designs.pdf>

CITY OF NEW YORK
DEPARTMENT OF ENVIRONMENTAL PROTECTION
OFFICE OF GREEN INFRASTRUCTURE
STANDARD FOR 20'X5' R.O.W. BIOSWALE TYPE 1B - WITH STORMWATER INLET
 - NO CONNECTION TO SEWERS

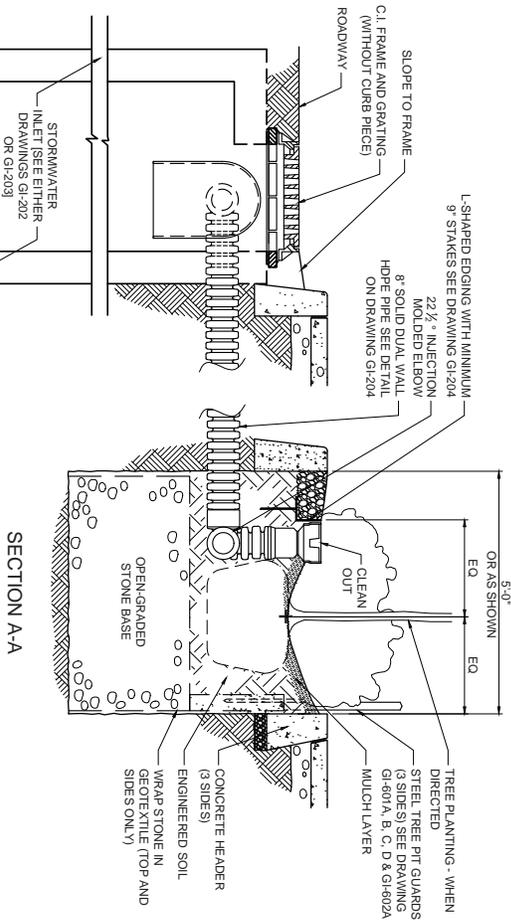
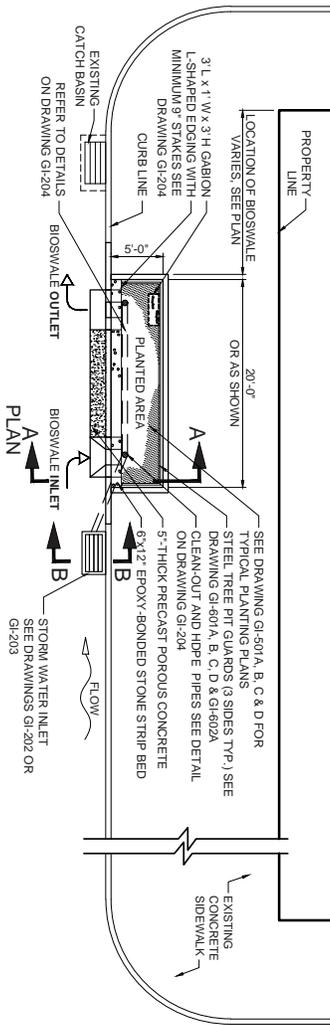

NOTES:

1. THE CONTRACTOR SHALL BE REQUIRED TO REMOVE AND REPLACE ALL EXISTING FULL SIDEWALK FLAGS ADJACENT TO THE PERIMETER OF THE BIOSWALE IN ADDITION TO ANY PARTIAL FLAG AREAS LEFT OVER DUE TO CONSTRUCTION. THE CONTRACTOR SHALL REPLACE THE SIDEWALK IN FULL COMPLIANCE WITH THE APPLICABLE SECTIONS OF THE STANDARD HIGHWAY SPECIFICATIONS.
2. THE CONTRACTOR SHALL REMOVE AND RESTORE ONE-AND-A-HALF (1 1/2) FOOT WIDTH OF THE WEARING COURSE AND ONE-AND-A-HALF (1 1/2) FOOT WIDTH OF ROADWAY CONCRETE PAVEMENT BASE ALONG THE CURB LINE AND ADJACENT APPLICABLE SECTIONS OF THE STANDARD HIGHWAY SPECIFICATIONS.
3. THE CONTRACTOR SHALL OBTAIN THE NECESSARY TREE PLANTING PERMIT FROM THE NYC DEPARTMENT OF PARKS AND RECREATION (DPR) PRIOR TO THE START OF WORK. ALL NECESSARY TREE PLANTING SHALL BE SUPERVISED BY CERTIFIED ARBORISTS.
4. NO TREE SHALL BE REMOVED BY THE CONTRACTOR UNTIL SPECIFICALLY ORDERED IN WRITING TO DO SO BY THE ENGINEER AND WITH APPROVAL FROM DPR.
5. TREES SHALL BE STAKED AS PER DOT STANDARD DETAILS OF CONSTRUCTION. TREE STAKES ARE TO BE REMOVED BY THE CONTRACTOR NOT LESS THAN ONE YEAR AFTER PLANTING.
6. THE CONTRACTOR SHALL NOT BE PERMITTED TO OPERATE AUXILIARY EQUIPMENT WHICH GENERATES EXHAUST OR OTHER HEAVY VIBRATION (E.G., GENERATORS AND COMPRESSORS) UNDER THE BRANCHES OF TREES WHERE THE STAKES ARE TO BE PLANTED, UNLESS APPROVED BY THE ENGINEER IN CONSULTATION WITH THE CERTIFIED ARBORIST.
7. THE CONTRACTOR SHALL NOT BE PERMITTED TO STORE, STOCKPILE, OR LAY DOWN ANY CONSTRUCTION MATERIAL INCLUDING BUT NOT LIMITED TO, LUMBER, FUEL, AND OIL CONTAINERS, PIPES AND/OR PIPE FITTINGS, BARRICADES, HAND TOOLS, HOSES, RECEPTACLES, AND ASPHALT WITHIN ANY EXISTING TREE PIT OR R.O.W. BIOSWALE.
8. REPLACEMENT TREES SHALL BE PLANTED WITHIN THE PROJECT AS DIRECTED BY THE ENGINEER IN ACCORDANCE WITH STANDARD HIGHWAY SPECIFICATIONS.
9. STONE STRIP BED TO BE BONDED WITH EPOXY TO KEEP STONES IN PLACE. STONES IN FRONT OF INLETS AND OUTLETS ARE TO BE LEFT LOOSE AND UNBONDED.
10. FOR R.O.W. GI PRACTICES WITH DIMENSIONS THAT DEVIATE FROM THE GI STANDARDS AS SHOWN ON CONTRACT PLANS DUE TO FIELD CONDITIONS, REFER TO THE DIMENSION SCHEDULE ON GI-122 AND SPECIFICATIONS.

Maedi F. Asce
 P.E., F. ASCE

ASSISTANT COMMISSIONER, OFFICE OF GREEN INFRASTRUCTURE
 DEPARTMENT OF ENVIRONMENTAL PROTECTION

06-15-2016
 DATE

NOTE: NO STAKE SHALL BE DRIVEN INTO HDPE DUAL WALL PIPE

CITY OF NEW YORK
 DEPARTMENT OF ENVIRONMENTAL PROTECTION
 OFFICE OF GREEN INFRASTRUCTURE
STANDARD FOR 20'X5' R.O.W. BIOSWALE TYPE 1B - WITH STORMWATER INLET
 - NO CONNECTION TO SEWERS

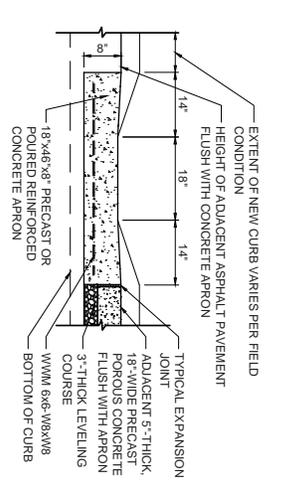
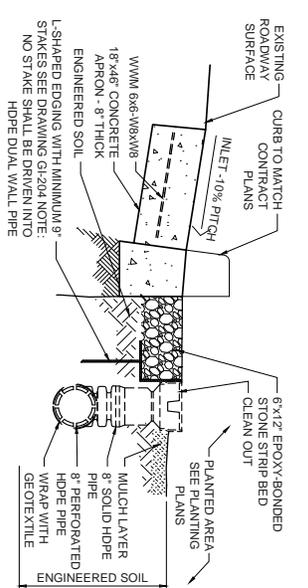
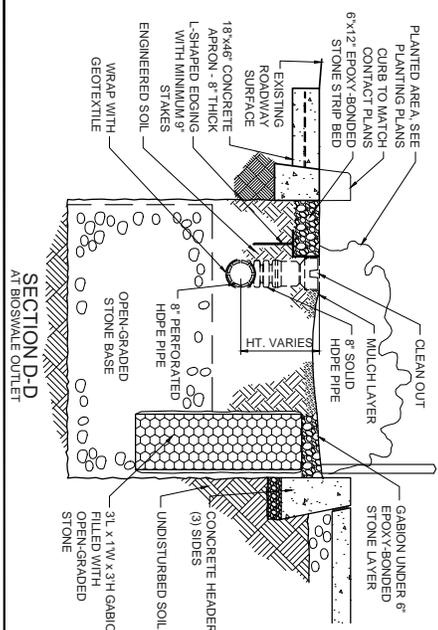
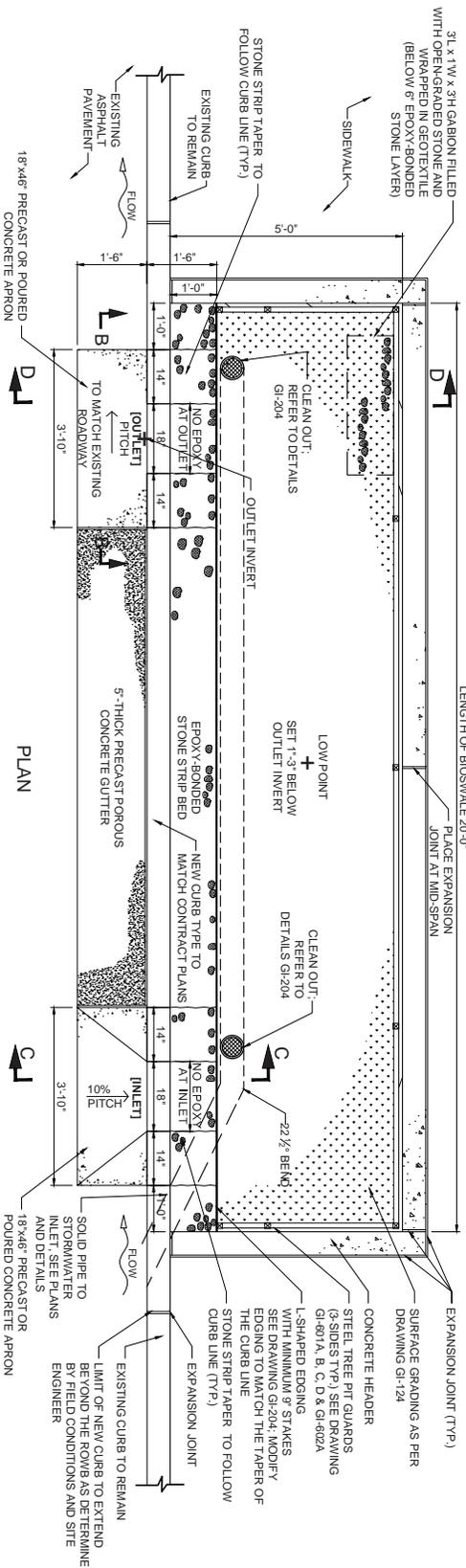

Madi Fung
 ASSISTANT COMMISSIONER, OFFICE OF GREEN INFRASTRUCTURE
 DEPARTMENT OF ENVIRONMENTAL PROTECTION
 P.E., F. ASCE
 06-15-2016
 DATE

CITY OF NEW YORK
 DEPARTMENT OF ENVIRONMENTAL PROTECTION
 OFFICE OF GREEN INFRASTRUCTURE
GUIDELINES FOR ON-SITE POROUS AND PERMEABLE SURFACES
 - NO CONNECTION TO SEWERS

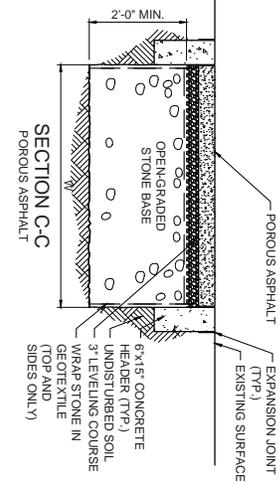
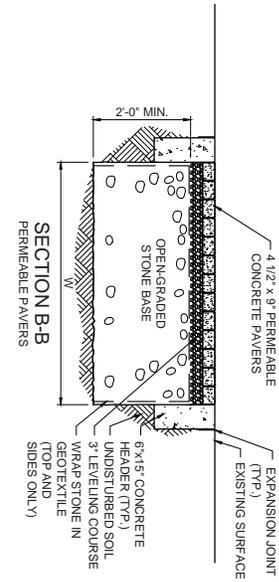
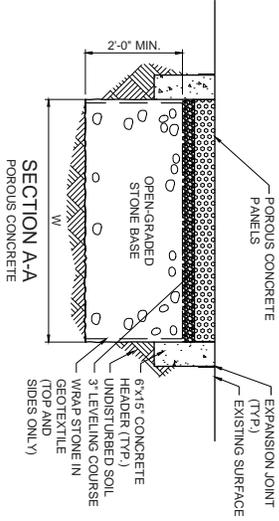
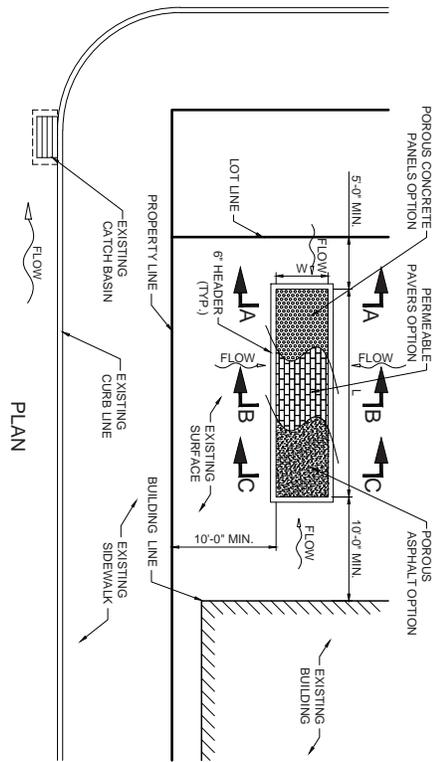

CITY OF NEW YORK
 DEPARTMENT OF ENVIRONMENTAL PROTECTION
 OFFICE OF GREEN INFRASTRUCTURE
GUIDELINES FOR LAYOUT OF ON-SITE BIORETENTION RAIN GARDEN
 - NO CONNECTION TO SEWERS

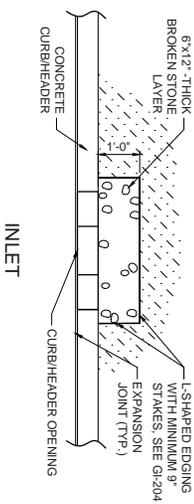
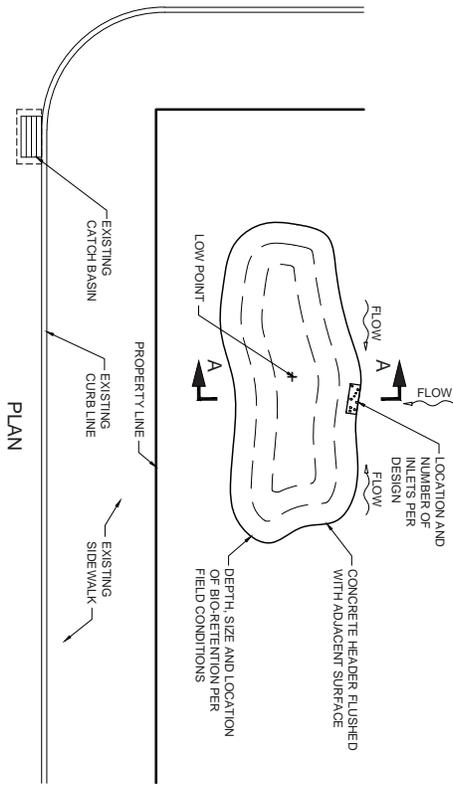

NOTES:
 SUBMIT X-SECTION AND PLAN FOR ALTERNATE DESIGN.

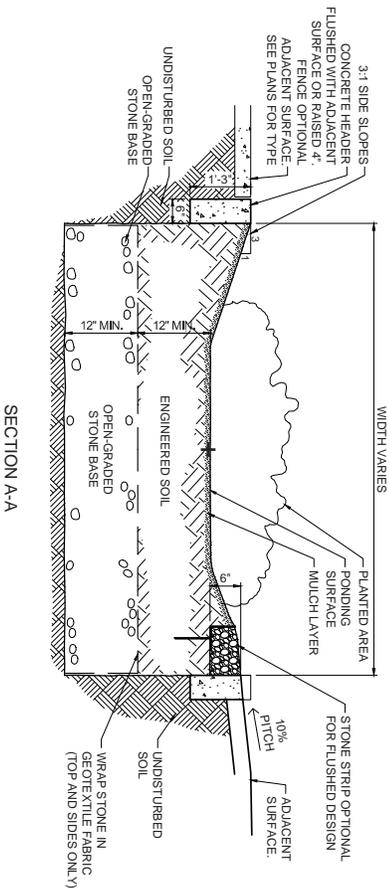

- GENERAL NOTES:
1. USE OFFICE OF GREEN INFRASTRUCTURE SPECIFICATIONS WHERE APPLICABLE UNLESS OTHERWISE DIRECTED/PER OWNER AGENCY
 2. CLEARANCE TO BUILDINGS, STRUCTURES/FOUNDATIONS, VAULTS, RETAINING WALLS AND OTHERS AS REQUIRED
 3. PLANTING PLAN PER OWNER AGENCY REQUIREMENTS

CITY OF NEW YORK
 DEPARTMENT OF ENVIRONMENTAL PROTECTION
 OFFICE OF GREEN INFRASTRUCTURE
STANDARD FOR R.O.W. RAIN GARDEN TYPE 1, TYPE 2, AND TYPE 3
 - NO CONNECTION TO SEWERS

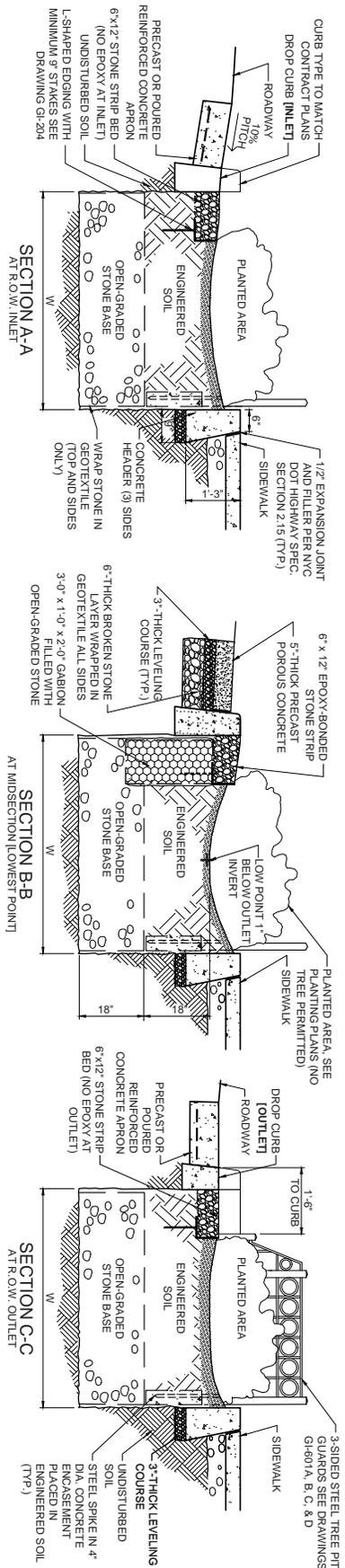
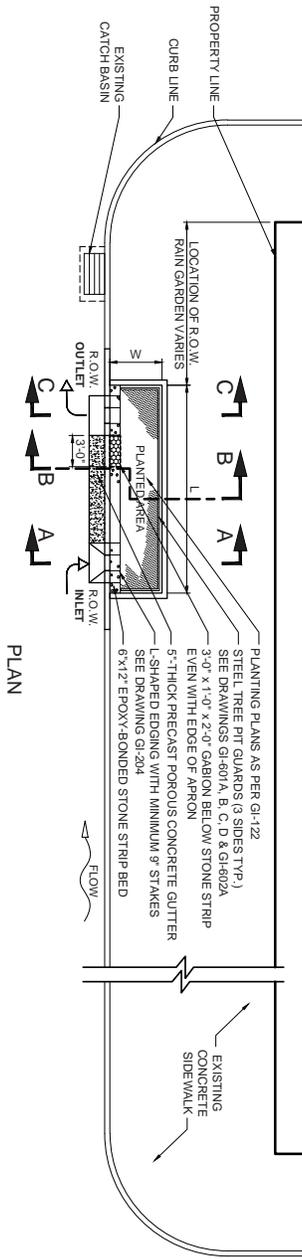

R.O.W. RAIN GARDEN DETAILS		
LENGTH (L) 4 FT INCREMENT	WIDTH (W) 6 IN INCREMENT	TYPE
17 ≤ L ≤ 20'	4'-0" TO 6'-0"	TYPE 1
13 ≤ L ≤ 16'	4'-0" TO 6'-0"	TYPE 2
10 ≤ L ≤ 12'	4'-0" TO 6'-0"	TYPE 3

NOTE:
 PLANT LAYOUT DIMENSIONS AND PLANTING PLANS AS PER GI-122 FOR THE R.O.W. RAIN GARDEN TYPE SPECIFIED.

Maedi Fawad
 ASSISTANT COMMISSIONER, OFFICE OF GREEN INFRASTRUCTURE
 DEPARTMENT OF ENVIRONMENTAL PROTECTION

P. E. F. ASCE
 DATE: 06-15-2016

CITY OF NEW YORK
 DEPARTMENT OF ENVIRONMENTAL PROTECTION
 OFFICE OF GREEN INFRASTRUCTURE
DIMENSION SCHEDULE FOR VARIABLE SIZE R.O.W. BIOSWALES AND R.O.W. RAIN GARDENS
 - NO CONNECTION TO SEWERS

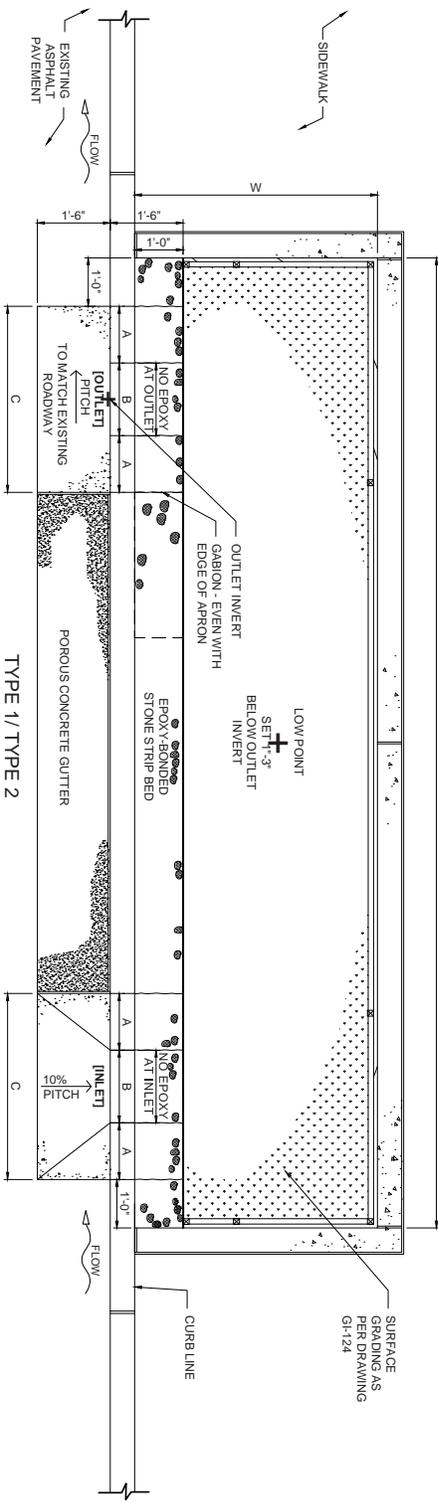

R.O.W. BIOSWALE OR RAIN GARDEN DETAILS		INLET/OUTLET DIMENSIONS			PLANTING PLAN
LENGTH (L), 1FT. INCREMENT	WIDTH (W), 6 IN. INCREMENT	A	B	C	TYPE / PAGE NUMBER
17 ≤ L ≤ 20'	4'-0" TO 6'-0"	TYPE 1	14"	18"	TYPE 1 / GI-501A-D
13 ≤ L ≤ 16'	4'-0" TO 6'-0"	TYPE 2	10"	14"	TYPE 2 / GI-502A-D
10 ≤ L ≤ 12'	4'-0" TO 6'-0"	TYPE 3	6"	12"	TYPE 3 / GI-503A-D

DIMENSION AND PLANTING PLAN SCHEDULE

- NOTES:
- STANDARD CROSS-SECTIONAL DETAILS AND NOTES AS PER THE R.O.W. BIOSWALE OR R.O.W. RAIN GARDEN TYPE SPECIFIED.
 - PRIOR TO CONSTRUCTION, THE CONTRACTOR WILL CONFIRM THE LEVELS OF THE R.O.W. BIOSWALE OR R.O.W. RAIN GARDEN TO PREVENT FLOODING.
 - DOT APPROVAL REQUIRED FOR ALL WIDTHS GREATER THAN 5'.
 - PLANTING QUANTITIES AND PLANS FOR VARIABLE WIDTH R.O.W. BIOSWALES AND R.O.W. RAIN GARDENS AS PER THE PAGE NUMBERS SPECIFIED DISTRIBUTED EVENLY.
 - TREES SPECIES AS DIRECTED BY DPR. TREES ARE ONLY PERMITTED IN R.O.W. BIOSWALES WITH AN ENGINEERED SOIL LAYER 24" DEEP.
 - * INLET DIMENSIONS ONLY

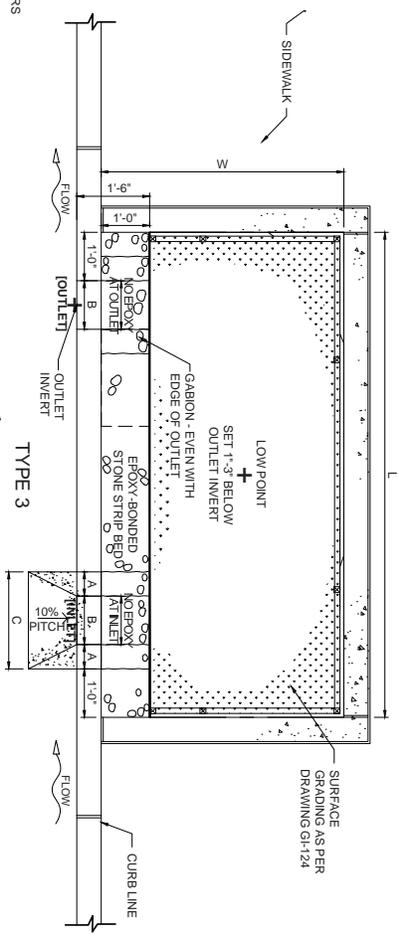

Maedi Fawad
 P.E., F. ASCE
 ASSISTANT COMMISSIONER, OFFICE OF GREEN INFRASTRUCTURE
 DEPARTMENT OF ENVIRONMENTAL PROTECTION

06-15-2016
 DATE

CITY OF NEW YORK
 DEPARTMENT OF ENVIRONMENTAL PROTECTION
 OFFICE OF GREEN INFRASTRUCTURE
SURFACE GRADING PLANS FOR R.O.W. BIOSWALES AND R.O.W. RAIN GARDENS
 - NO CONNECTION TO SEWERS

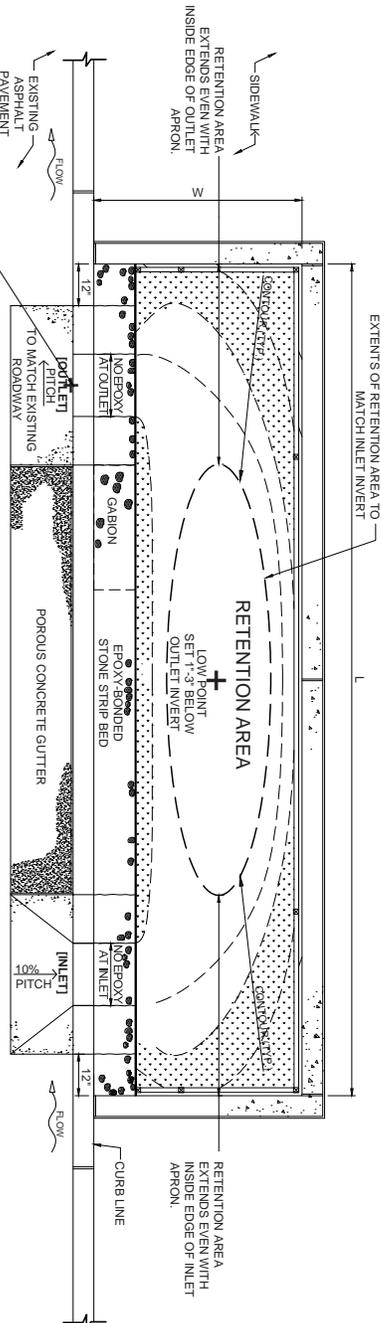

GRADING PLAN 1
 FOR ALL ROWS WITH
 L = 13 OR GREATER

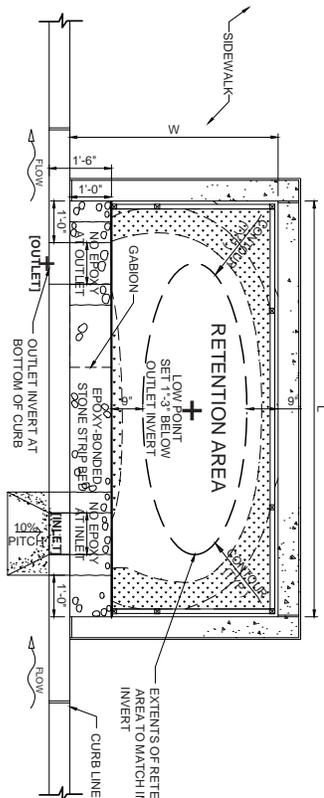

GRADING PLAN 2
 FOR ROWS WITHOUT STONE COLUMN AND
 L = LESS THAN 13'

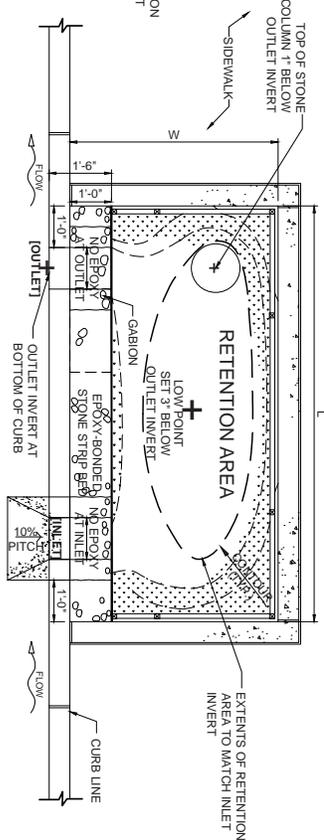

GRADING PLAN 3
 FOR ROWS WITH STONE COLUMN AND
 L = LESS THAN 13'

- NOTES
1. ALL SURFACE GRADING TO TAPER TOWARD THE LOW POINT.
 2. CONTOUR LINES SHOWN ON THIS DRAWING ARE SCHEDULE GRADE AND DEPEND ON THE STREET GRADE.

Maedi Fawad
 P. E. F. ASCE
 ASSISTANT COMMISSIONER, OFFICE OF GREEN INFRASTRUCTURE
 DEPARTMENT OF ENVIRONMENTAL PROTECTION

06-15-2016
 DATE

CITY OF NEW YORK
 DEPARTMENT OF ENVIRONMENTAL PROTECTION
 OFFICE OF GREEN INFRASTRUCTURE
STANDARD R.O.W. BIOSWALE DETAILS

GI-204

GI-204

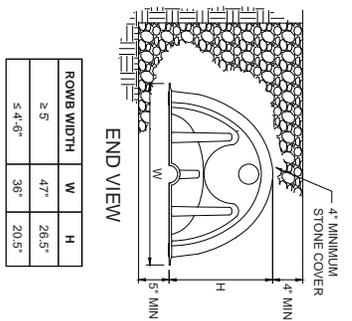
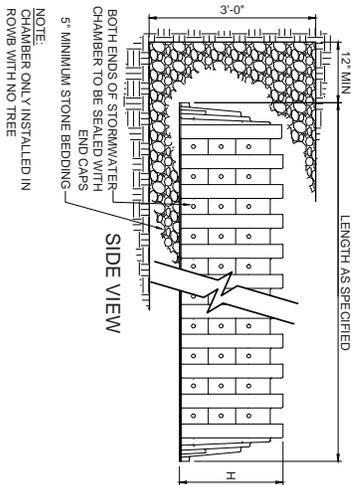

DIMENSION SCHEDULE

ROWS WIDTH	W	H
2.5'	47"	28.5"
5.4-6'	36"	20.5"

STORMWATER CHAMBER
N.T.S.

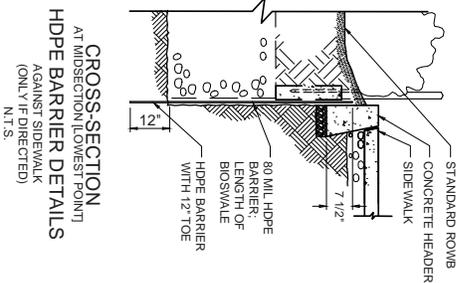

CROSS-SECTION AT WIDEST POINT (LOWEST POINT) AGAINST SIDEWALK
N.T.S.

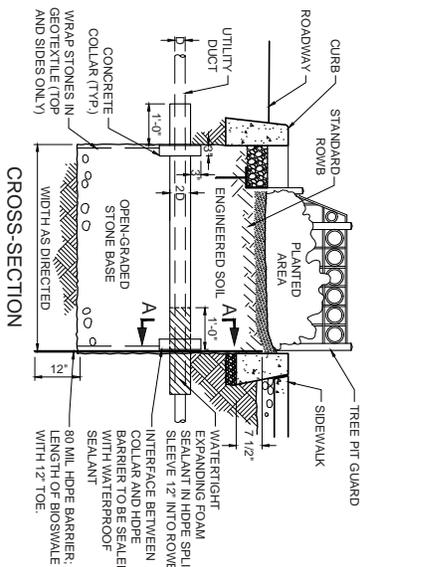

CROSS-SECTION
NOTE: ANY SEAMS IN THE HDPE BARRIER MUST HAVE A 1'-0\"/>

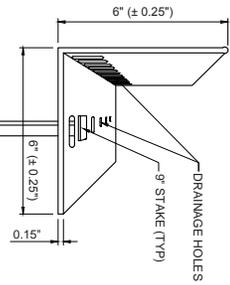

L-SHAPED EDGING
N.T.S.

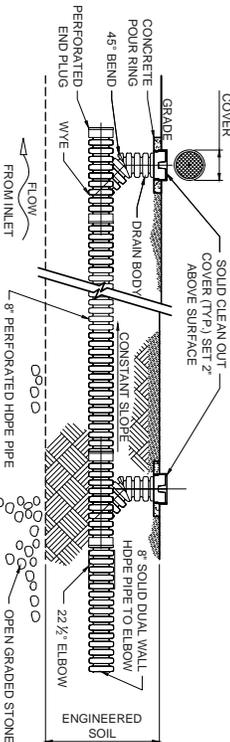

CLEAN-OUT DETAIL - HDPE PIPE
N.T.S.

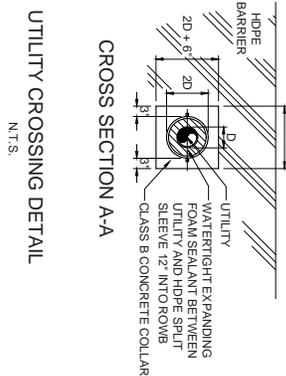

CROSS SECTION A-A
UTILITY CROSSING DETAIL
N.T.S.

Maedi Fung
 P. E., F. ASCE
 ASSISTANT COMMISSIONER, OFFICE OF GREEN INFRASTRUCTURE
 DEPARTMENT OF ENVIRONMENTAL PROTECTION

06-15-2016
 DATE

STANDARD PLANTING PLANS FOR TYPE 1 R.O.W. BIOSWALES AND R.O.W. RAIN GARDENS

CITY OF NEW YORK
DEPARTMENT OF ENVIRONMENTAL PROTECTION
OFFICE OF GREEN INFRASTRUCTURE

RESIDENTIAL PLAN 1 PLANT SCHEDULE

QUAN	KEY	PLANT VERSION	TYPE	BOTANICAL NAME	COMMON NAME	SIZE	SPACING
8	A		SHRUB	ILEX GLABRA 'SHAMROCK'	INKBERRY	#5 CONT. OR 18" B	2' O.C.
	B		ROSE	ROSA 'PARADISE KNOCK OUT'	SHRUB ROSE	#5 CONT. OR 18" B	2' O.C.
22	A		PERENNIAL	'COROPUS FRESHWATER'	TICKSEED	#2 CONT.	12" O.C.
	B		PERENNIAL	NERITA X EMBASENII 'WALDERS LOW'	CATTYANT	#2 CONT.	12" O.C.
31	A		GROUND COVER	LIROPE MUSCARI	LIU TYURF	#1 CONT.	12" O.C.
	B		GROUND COVER	LIROPE MUSCARI 'MORICE WHITE'	LIU TYURF	#1 CONT.	12" O.C.
5	A		PERENNIAL	'COROPUS FRESHWATER'	TICKSEED	#2 CONT.	12" O.C.
	B		PERENNIAL	NERITA X EMBASENII 'WALDERS LOW'	CATTYANT	#2 CONT.	12" O.C.
1	A		GROUND COVER	LIROPE SPICATA	LIU TYURF	#1 CONT.	12" O.C.
	B		GROUND COVER	LIROPE MUSCARI 'MORICE WHITE'	LIU TYURF	#1 CONT.	12" O.C.

RESIDENTIAL PLAN 2 PLANT SCHEDULE

QUAN	KEY	PLANT VERSION	TYPE	BOTANICAL NAME	COMMON NAME	SIZE	SPACING
20	A		SHRUB	ILEX GLABRA 'SHAMROCK'	INKBERRY	#5 CONT. OR 18" B	2' O.C.
	B		SHRUB	ILEX GLABRA 'SHAMROCK'	INKBERRY	#5 CONT. OR 18" B	2' O.C.
8	A		ROSE	ROSA 'PALUSTRIAS'	SHRUB ROSE	#2/#3 CONT.	18" O.C.
	B		SHRUB	CLETHRA ANGIOLA 'HUMMINGBIRD'	SWEET PEPPERBUSH	#5 CONT. OR 18" B	18" O.C.
11	A		PERENNIAL	ECHINOGA POLYPERNA 'KIM'S KNEE HIGH'	PURPLE CONE FLOWER	#2 CONT.	12" O.C.
	B		PERENNIAL	RUBRICA SUBTENDENTOSA 'HENRY EILERS'	SWEET CONE FLOWER	#2 CONT.	12" O.C.
6	A		GRASSES	ACORUS CALAMUS 'VAREGATUS'	SWEETFLAG	#2 CONT.	12" O.C.
	B		GRASSES	ACORUS CALAMUS 'VAREGATUS'	SWEETFLAG	#2 CONT.	12" O.C.
4	A		PERENNIAL	ECHINOGA POLYPERNA 'KIM'S KNEE HIGH'	PURPLE CONE FLOWER	#2 CONT.	12" O.C.
	B		PERENNIAL	RUBRICA SUBTENDENTOSA 'HENRY EILERS'	SWEET CONE FLOWER	#2 CONT.	12" O.C.

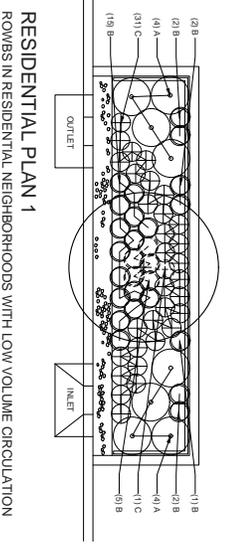

RESIDENTIAL PLAN 1
ROWS IN RESIDENTIAL NEIGHBORHOODS WITH LOW VOLUME CIRCULATION

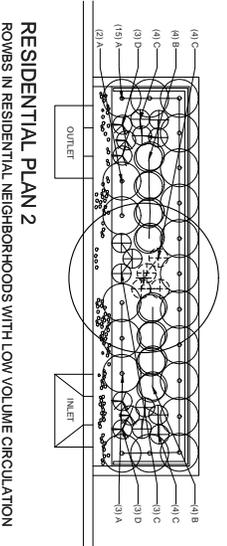

RESIDENTIAL PLAN 2
ROWS IN RESIDENTIAL NEIGHBORHOODS WITH LOW VOLUME CIRCULATION

- NOTES:**
1. PLANTING LOCATIONS ARE SPECIFIC TO THE INLET AND OUTLET ORIENTATION SHOWN. IF THE INLET AND OUTLET ORIENTATION IS REVERSED, THE PLANTING LOCATIONS MUST BE MIRRORED.
 2. TREES TO BE INCLUDED IN PLANTING PLANS UPON DIRECTION OF DPR.
 3. THE AREA DIRECTLY ABOVE THE TREE ROOTBALL IS NOT TO BE PLANTED WITH SHRUBS, PERENNIALS, OR GRASSES.
 4. PLANTING PLANS FOR VARIABLE SIZE R.O.W. BIOSWALES AND R.O.W. RAIN GARDENS ARE DETERMINED AS PER THE SCHEDULE ON GI-122.

 R.L.A. LEED AP
 DIRECTOR OF GREEN INFRASTRUCTURE
 DEPARTMENT OF PARKS AND RECREATION
 03-07-2016
 DATE

 P.E. F. ASCE
 ASSISTANT COMMISSIONER, OFFICE OF GREEN INFRASTRUCTURE
 DEPARTMENT OF ENVIRONMENTAL PROTECTION
 03-07-2016
 DATE